



Automotive
Energy & Power Analysis
Field Service
Environmental
Research & Development

DEWE-4012

Technical reference manual



ISO9001

... the precision signal conditioning company



Copyright © DEWETRON elektronische Messgeraete Ges.m.b.H.

This document contains information which is protected by copyright. All rights are reserved. Reproduction, adaptation, or translation without prior written permission is prohibited, except as allowed under the copyright laws.

All trademarks and registered trademarks are acknowledged to be the property of their owners.

Content

General Information, Safety Instructions	5
Warranty Information	5
Support	5
Printing History.....	5
Safety symbols in the manual	6
Safety instructions for all DEWETRON systems	7
Environmental Considerations	8
Main System	9
DEWE-4012 PC instrument	9
System specifications	9
Connectors	10
How to mount the mounting-kit option (4010-MK)	15
A/D & D/A Conversion	A1
Internal Wiring	B1
EC-Certificate of conformity	C1

Technical Reference

The information contained in this document is subject to change without notice.

DEWETRON elektronische Messgeraete Ges.m.b.H. (DEWETRON) shall not be liable for any errors contained in this document. DEWETRON MAKES NO WARRANTIES OF ANY KIND WITH REGARD TO THIS DOCUMENT, WHETHER EXPRESS OR IMPLIED. DEWETRON SPECIFICALLY DISCLAIMS THE IMPLIED WARRANTIES OF MERCHANTABILITY AND FITNESS FOR A PARTICULAR PURPOSE. DEWETRON shall not be liable for any direct, indirect, special, incidental, or consequential damages, whether based on contract, tort, or any other legal theory, in connection with the furnishing of this document or the use of the information in this document.

Warranty Information

A copy of the specific warranty terms applicable to your DEWETRON product and replacement parts can be obtained from your local sales and service office.

Support

For any support please contact your local distributor first or DEWETRON directly.

For Asia and Europe, please contact:

DEWETRON Ges.m.b.H.
Parkring 4
A-8074 Graz-Grambach
AUSTRIA
Tel.: +43 316 3070
Fax: +43 316 307090
Email: support@dewetron.com
Web: <http://www.dewetron.com>

The telephone hotline is available
Monday to Friday between
08:00 and 17:00 CET (GMT +1:00)

For the Americas, please contact:

DEWETRON, Inc.
10 High Street, Suite K
Wakefield, RI 02879
U.S.A.
Tel.: +1 401 284 3750
Toll-free: +1 877 431 5166
Fax: +1 401 284 3755
Email: support@dewamerica.com
Web: <http://www.dewamerica.com>

The telephone hotline is available
Monday to Friday between
08:00 and 17:00 GST (GMT -5:00)

Restricted Rights Legend

Use austrian law for duplication or disclosure.

DEWETRON GesmbH
Parkring 4
A-8074 Graz-Grambach / Austria

Printing History

Please refer to the page bottom for printing version.

Copyright © DEWETRON elektronische Messgeraete Ges.m.b.H.

This document contains information which is protected by copyright. All rights are reserved. Reproduction, adaptation, or translation without prior written permission is prohibited, except as allowed under the copyright laws.

All trademarks and registered trademarks are acknowledged to be the property of their owners.

Safety instructions

Safety symbols in the manual



Indicates hazardous voltages.

WARNING *Calls attention to a procedure, practice, or condition that could cause bodily injury or death.*

CAUTION *Calls attention to a procedure, practice, or condition that could possibly cause damage to equipment or permanent loss of data.*

WARNINGS

The following general safety precautions must be observed during all phases of operation, service, and repair of this product. Failure to comply with these precautions or with specific warnings elsewhere in this manual violates safety standards of design, manufacture, and intended use of the product. DEWETRON Elektronische Messgeraete Ges.m.b.H. assumes no liability for the customer's failure to comply with these requirements.

All accessories shown in this document are available as option and will not be shipped as standard parts.



*For safety reasons max. 50 V may be applied to the BNC input-connectors!
Refer to the regulation of maximum allowable touch potential.*

Safety instructions for all DEWETRON systems

- The DEWETRON data acquisition systems may only be installed by experts.
- Read your manual before operating the system.
- Observe local laws when using the instrument.
- Ground the equipment: For Safety Class 1 equipment (equipment having a protective earth terminal), a non interruptible safety earth ground must be provided from the mains power source to the product input wiring terminals or supplied power cable.
- DO NOT operate the product in an explosive atmosphere or in the presence of flammable gases or fumes and do not bring the system in contact with water.
- DO NOT operate damaged equipment: Whenever it is possible that the safety protection features built into this product have been impaired, either through physical damage, excessive moisture, or any other reason, REMOVE POWER and do not use the product until safe operation can be verified by service-trained personnel. If necessary, return the product to a DEWETRON sales and service office for service and repair to ensure that safety features are maintained.
- Keep away from live circuits: Operating personnel must not remove equipment covers or shields. Procedures involving the removal of covers or shields are for use by service-trained personnel only. Under certain conditions, dangerous voltages may exist even with the equipment switched off. To avoid dangerous electrical shock, DO NOT perform procedures involving cover or shield removal unless you are qualified to do so.
- No modifications are allowed at the instrument. The fuse in the power module has to be replaced by the same type. For continued protection against fire, replace the line fuse(s) only with fuse(s) of the same voltage and current rating and type. DO NOT use repaired fuses or short-circuited fuse holder labels and print on the power module may not be removed.
- DO NOT service or adjust alone. Do not attempt internal service or adjustment unless another person, capable of rendering first aid and resuscitation, is present.
- DO NOT substitute parts or modify equipment: Because of the danger of introducing additional hazards, do not install substitute parts or perform any unauthorized modification to the product. Return the product to a DEWETRON sales and service office for service and repair to ensure that safety features are maintained.
- Before opening the instrument (experts only) or exchanging the fuse in the power module disconnect power!
- Don't touch internal wiring!
- Don't use higher supply voltage than specified and take care of the correct polarity, otherwise the system will be damaged!
- Use only original plugs and cables for harnessing.
- Install filler-panels in unused slots.
- The power-cable and -connector serve as Power-Breaker. The cable must not exceed 10 feet, disconnect function must be possible without tools.
- Keep the ventilation slots free and check them frequently to avoid an overheating of the system. The cleaning interval of the filter pads depends on the environmental conditions.
- Safety of the operator and the unit depend on following these rules.
- DEWETRON is not responsible for any damage or injury that could result from improper connection or misuse!

General Information

CAUTION

- The system BIOS is protected by password. Any change in the BIOS may cause a system crash. When the system is booting, do not press ESC-button on keyboard. This may clear the BIOS settings and cause system faults.
- Any change in the file structure as deleting or adding files or directories might cause a system crash.
- Before installing software updates contact DEWETRON or your local distributor. Use only software packages which are released by DEWETRON. Further informations are also available in the internet (<http://www.dewetron.com>).
- After power off the system wait at least 10 seconds before switching the system on again. Otherwise the system may not boot correct. This prolongs also the life of all system components.

Environmental Considerations

Information about the environmental impact of the product.

Product End-of-Life Handling

Observe the following guidelines when recycling a DEWETRON system:

System and Components Recycling

Production of these components required the extraction and use of natural resources. The substances contained in the system could be harmful to your health and to the environment if the system is improperly handled at it's end of life! Please recycle this product in an appropriate way to avoid an unnecessary pollution of the environment and to keep natural resources.



This symbol indicates that this system complies with the European Union's requirements according to Directive 2002/96/EC on waste electrical and electronic equipment (WEEE). Please find further informations about recycling on the DEWETRON web site www.dewetron.com



Restriction of Hazardous Substances

This product has been classified as Monitoring and Control equipment, and is outside the scope of the 2002/95/EC RoHS Directive. This product is known to contain lead.

DEWE-4012 PC instrument

- Portable data acquisition system
- Up to 16 channels with isolation
(in conjunction with DEWE-DAQ modules)
- Up to 48 MDAQ-channels
- Up to 256 channels with external
expansion racks or PAD modules
- A/D converter specs see appendix A



System specifications

	DEWE-4012															
	MDAQ-DIRECT	MDAQ-V-10	MDAQ-V-100	MDAQ-SUB-V-200	MDAQ-SUB-ACC-x	MDAQ-SUB-ACC-A-x	MDAQ-SUB-BRIDGE	MDAQ-SUB-STG	MDAQ-BASE-5	MDAQ-BASE-10	MDAQ-FILT-5-BU	MDAQ-FILT-5-BE	MDAQ-FILT-5-BU-S1	MDAQ-FILT-10	MDAQ-FILT-10-S1	MDAQ-AAF4-5-BU
Channel 16 to 23	<input type="checkbox"/>	<input type="checkbox"/>	<input type="checkbox"/>	<input type="checkbox"/>	<input type="checkbox"/>	<input type="checkbox"/>	<input type="checkbox"/>	<input type="checkbox"/>	<input type="checkbox"/>	<input type="checkbox"/>	<input type="checkbox"/>	<input type="checkbox"/>	<input type="checkbox"/>	<input type="checkbox"/>	<input type="checkbox"/>	<input type="checkbox"/>
Channel 24 to 31	<input type="checkbox"/>	<input type="checkbox"/>	<input type="checkbox"/>	<input type="checkbox"/>	<input type="checkbox"/>	<input type="checkbox"/>	<input type="checkbox"/>	<input type="checkbox"/>	<input type="checkbox"/>	<input type="checkbox"/>	<input type="checkbox"/>	<input type="checkbox"/>	<input type="checkbox"/>	<input type="checkbox"/>	<input type="checkbox"/>	<input type="checkbox"/>
Channel 32 bis 39	<input type="checkbox"/>	<input type="checkbox"/>	<input type="checkbox"/>	<input type="checkbox"/>	<input type="checkbox"/>	<input type="checkbox"/>	<input type="checkbox"/>	<input type="checkbox"/>	<input type="checkbox"/>	<input type="checkbox"/>	<input type="checkbox"/>	<input type="checkbox"/>	<input type="checkbox"/>	<input type="checkbox"/>	<input type="checkbox"/>	<input type="checkbox"/>
Channel 40 to 47	<input type="checkbox"/>	<input type="checkbox"/>	<input type="checkbox"/>	<input type="checkbox"/>	<input type="checkbox"/>	<input type="checkbox"/>	<input type="checkbox"/>	<input type="checkbox"/>	<input type="checkbox"/>	<input type="checkbox"/>	<input type="checkbox"/>	<input type="checkbox"/>	<input type="checkbox"/>	<input type="checkbox"/>	<input type="checkbox"/>	<input type="checkbox"/>
Channel 48 to 55	<input type="checkbox"/>	<input type="checkbox"/>	<input type="checkbox"/>	<input type="checkbox"/>	<input type="checkbox"/>	<input type="checkbox"/>	<input type="checkbox"/>	<input type="checkbox"/>	<input type="checkbox"/>	<input type="checkbox"/>	<input type="checkbox"/>	<input type="checkbox"/>	<input type="checkbox"/>	<input type="checkbox"/>	<input type="checkbox"/>	<input type="checkbox"/>
Channel 56 to 63	<input type="checkbox"/>	<input type="checkbox"/>	<input type="checkbox"/>	<input type="checkbox"/>	<input type="checkbox"/>	<input type="checkbox"/>	<input type="checkbox"/>	<input type="checkbox"/>	<input type="checkbox"/>	<input type="checkbox"/>	<input type="checkbox"/>	<input type="checkbox"/>	<input type="checkbox"/>	<input type="checkbox"/>	<input type="checkbox"/>	<input type="checkbox"/>
Power supply:	<input type="checkbox"/> 300 W AC ATX power supply FSP300-60PFN/PLN <input type="checkbox"/> 400 W AC ATX power supply FSP400-60PFN/PLN <input type="checkbox"/> 400 W AC ATX power supply MPM-842P <input type="checkbox"/> 300 W DC ATX power supply APT-DX300HEW <input type="checkbox"/> 300 W DC ATX power supply APT-DY300H for details see next pages															
Operating temperature:	-5 °C to 50 °C (standard)															
Storage temperature:	-20 °C to +70 °C															
Humidity (operating):	10 % to 80 %, non condensing 5 % to 95 %, rel. humidity															
Vibration:	MIL-STD 810F 514.5 procedure I operating test procedure frequency range: 5 to 200 to 5 Hz; 5 x 12 min each direction displacement amplitude ±3.5 mm (5 to 8.45 Hz) acceleration amplitude 1 g (8.45 to 92 Hz) displacement amplitude 92 to 113 Hz: ±0.029 mm acceleration amplitude 1.5 g (113 to 200 Hz)															
Shock:	MIL-STD 810F 516.5 procedure I non operating test procedure ½ sinus 11 ms 10 g, 3 shocks positive, 3 shocks negative															
Dimensions (W x D x H):	approx. 440 x 221 x 398 mm (17.3 x 8.7 x 15.7 in.)															
Weight:	typ. 18 kg (40 lbs), depending on configuration															

Main System

Connectors

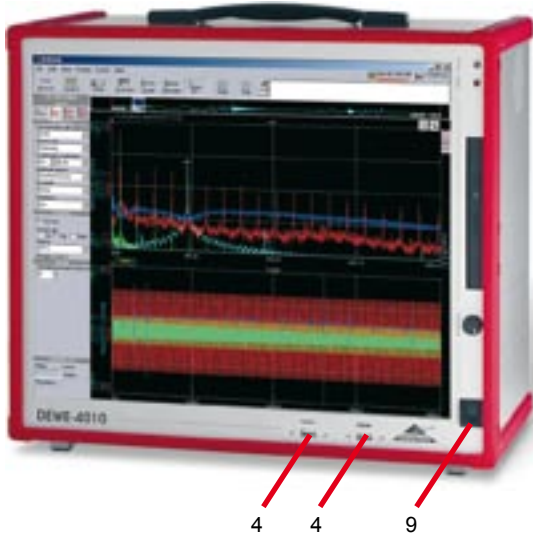

Typical DEWE-4012 front view

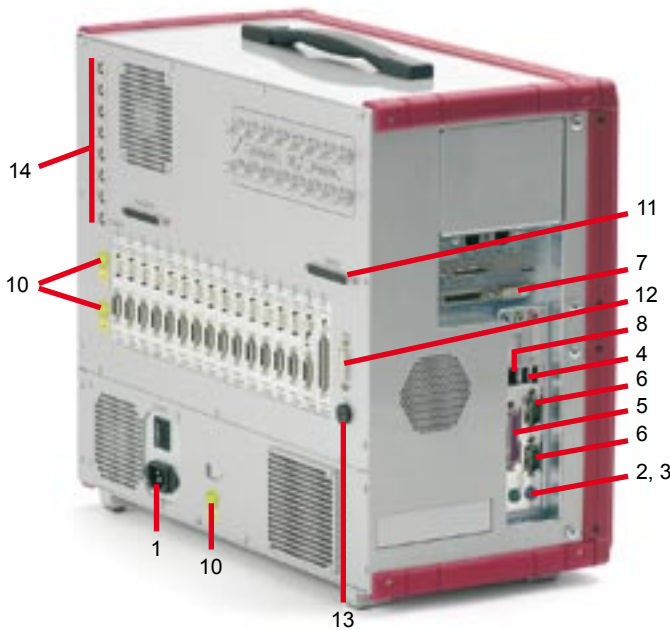

Typical DEWE-4012 rear view

Connector overview:

1. Power supply connector with general power switch
2. PS/2 keyboard connector
3. PS/2 mouse connector
4. USB interface connectors
5. LPT interface connector
6. RS-232 interface connector
7. LVDS and DVI connector
8. Ethernet LAN connector
9. Power-on button
10. Ground connectors
11. Digital I/O connector
12. EPAD connector
13. EPAD fuse
14. Optional counter inputs

Note: The location of the connectors might vary from system to system and depends on system configuration

Power supply connectors

300/400 W AC power supply

AC power supply	300 W AC ATX power supply FSP300-60PFN/PLN	400 W AC ATX power supply FSP400-60PFN/PLN
Input:		
Input range:	100 to 240 V _{AC} (auto selecting)	100 to 240 V _{AC} (auto selecting)
Input frequency:	50 to 60 Hz	50 to 60 Hz
Max. input current:	10 A (115 V _{AC}) or 5 A (230 V _{AC})	10 A (115 V _{AC}) or 5 A (230 V _{AC})
Output:		
Output power:	300 W (max. 180 W @ +3.3 V and +5 V)	400 W (max. 235 W @ +3.3 V and +5 V)
Output voltages:	+3.3 V (max. 28 A) +5 V (max. 30 A) -5 V (max 0.3 A) +5 Vsb (max. 2 A) +12 V (max. 15 A) -12 V (max. 0.8 A)	+3.3 V (max. 28 A) +5 V (max. 40 A) -5 V (max 0.3 A) +5 Vsb (max. 2 A) +12 V (max. 15 A) -12 V (max. 0.8 A)

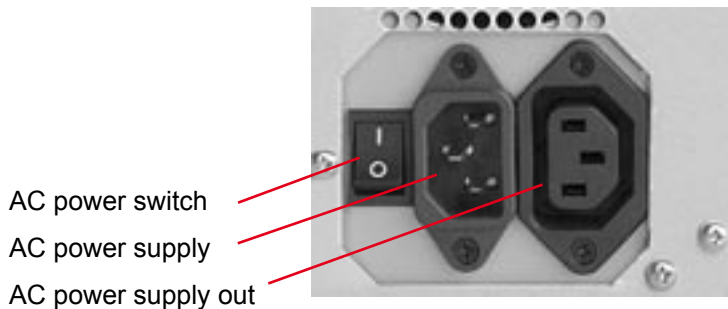

400 W AC power supply

AC power supply	400 W AC ATX power supply MPM-842P
Input:	
Input range:	100 to 240 V _{AC} (auto selecting)
Input frequency:	47 to 63 Hz
Max. input current:	8 A (115 V _{AC})
Output:	
Output power:	400 W continuous (450 W peak)
Output voltages:	+3.3 V (max. 22 A) +5 V (max. 21 A) +5 Vsb (max. 1.5 A) +12 V (max. 22 A) -12 V (max. 0.8 A)

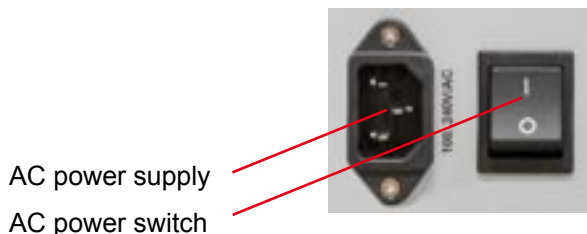

Main System

300 W DC power supply

300 W DC power supply		APT-DX 300HEW	
Input:			
Input range:	9 to 18 V _{DC} (12 V _{DC} nom.)		
Input frequency:	DC		
Max. input current:	50 A		
Output:			
Output power:	300 W		
Output voltages:	+3.3 V (max. 20 A, min. 0.3 A)		
	+5 V (max. 35 A, min. 0.3 A)		-5 V (max. 0.5 A)
	+5 Vsb (max. 2 A)		
	+12 V (max. 15 A)		-12 V (max. 1 A)

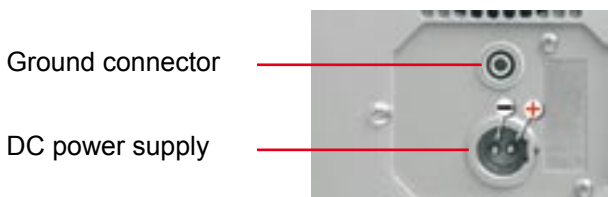

300 W DC power supply

300 W DC power supply		APT-DY300HEW	
Input:			
Input range:	18 to 36 V _{DC} (24 V _{DC} nom.)		
Input frequency:	DC		
Max. input current:	25 A		
Output:			
Output power:	300 W		
Output voltages:	+3.3 V (max. 28 A)		
	+5 V (max. 30 A, min. 3 A, peak 35 A)		-5 V (max. 1 A)
	+5 Vsb (max. 1.5 A)		
	+12 V (max. 12 A, min. 1 A, peak 15 A)		-12 V (max. 2 A)

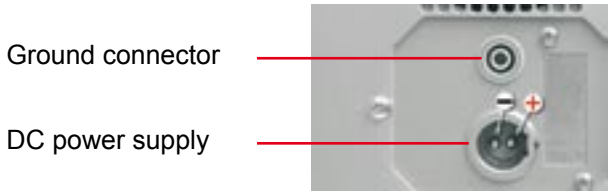

PS/2 mouse connector

The mouse / trackball connector is used to connect the trackball embedded in the keyboard or an external PS/2 mouse. The connector meets standard PS/2 pin assignment.

PS/2 keyboard connector

The keyboard connector is used to connect PS/2 keyboard to DEWE-4012 system. The connector meets standard PS/2 pin assignment.

USB interface connectors (Universal Serial Bus)

The USB interface connectors meets standard USB pin assignment.

LPT printer interface connector

The printer interface connector (female) is located on the left side of the DEWE-4012. It is configured as standard LPT interface.



25-pin SUB-D connector (female)

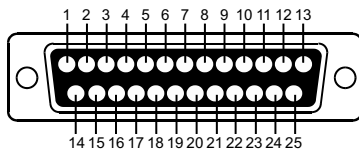

Schematic

Pin assignment

1: Strobe	14: Auto FD
2: Data 1	15: Error
3: Data 2	16: Init
4: Data 3	17: Select In
5: Data 4	18: GND
6: Data 5	19: GND
7: Data 6	20: GND
8: Data 7	21: GND
9: Data 8	22: GND
10: ACK	23: GND
11: Busy	24: GND
12: PE	25: GND
13: Select	

RS-232 interface connector (COM1)

The RS-232 interface connector (male) is located on the left side of the DEWE-4012. It is configured as standard RS-232 interface COM 1 and can be used for mouse or other peripheral units.



9-pin SUB-D connector (male)

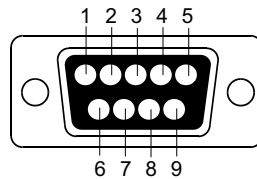

Schematic

Pin assignment

1: DCD (Data Carrier Detector)
2: RD (Received Data)
3: TD (Transmitted Data)
4: DTR (Data Terminal Ready)
5: GND (Ground)
6: DSR (Data Set Ready)
7: RTS (Request To Send)
8: CTS (Clear To Send)
9: RI (Ring Indicator)

VGA connector

The VGA connector offers the possibility to connect an external CRT or other standard VGA displays to the system.



15-pin mini-SUB-D connector (male)

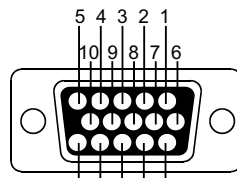

Schematic

Pin assignment

1: Red video
2: Green video / Sync on green
3: Blue video
4: -
5: -
6: Red video ground
7: Green video ground
8: Blue video ground
9: -
10: Ground
11: Ground
12: Data line
13: H-Sync / HV-Sync
14: V-Sync
15: Clock line

Main System

Some systems have a DVI connector instead or additionally to the VGA.

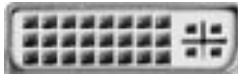

15-pin mini-SUB-D connector (male)

Schematic

Pin assignment

1: TDMS-data 2-	9: TDMS-data 1-	17: TDMS-data 0-	C1: Analog: red
2: TDMS-data 2+	10: TDMS-data 1+	18: TDMS-data 0+	C2: Analog: green
3: Shield TDMS-data 2,4	11: Shield TDMS-Daten 1,3	19: Shield TDMS-data 0,5	C3: Analog: blue
4: TDMS-data 4-	12: TDMS-data 3-	20: TDMS-data 5-	C4: Analog: H-Sync
5: TDMS-data 4+	13: TDMS-data 3+	21: TDMS-data 5+	C5: Analog: ground
6: DDC clock	14: +5 volt	22: Shield TDMS-Takt	
7: DDC data	15: Ground for +5 volt	23: TDMS-clock+	
8: Analog: V-Sync	16: Hotplug-Detect	24: TDMS-clock -	

Ethernet connector

The DEWE-4012 system supports 10/100 BaseT Ethernet with standard RJ45 connector.

Power-on button

The power-on button has to be used to switch on the system. It only works when the main power switch is on.

Power supply backplane / cooling fan

The AMP connector is the internal power supply connection to the internal rack and the cooling fan, mounted on the backplane of the DEWE-4012 system.

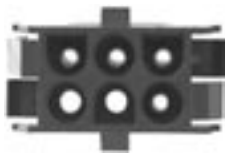

6-pin AMP connector

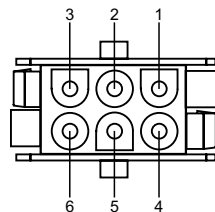

Schematic

Pin assignment

1: +12 V
2: GND
3: not connected
4: -12 V
5: GND (EPAD supply)
6: +12 V (EPAD supply)

Digital I/O connector

This connector supports digital input and output lines of the built-in A/D board. If this board does not support digital I/O's, the connector is not available.

The pin assignment is depending on A/D board used - details are available in appendix B.

Ground connectors

For some kind of measurements, it's necessary to give the system an additional ground connection.

How to mount the mounting-kit option (4010-MK)

The optional 19" mounting-kit offers the possibility to use the DEWE-4012 in a switching cabinet. Please mount both side panels first. Fasten the front panel (9 U) with the attached screws.



Main System

Notes

A/D & D/A Conversion

A/D Conversion

Detailed information about the A/D card are not included in this manual.

For detailed information see the manufacturer's A/D card manual.

D/A Conversion

Detailed information about the D/A card are not included in this manual.

For detailed information see the manufacturer's D/A card manual.

A/D & D/A Conversion

Notes

Internal Wiring

Please find information about the MDAQ amplifiers in the attached MDAQ-INT series modules manual. The latest version of the manual can be downloaded from:

<http://www.dewetron.com/download/index.php?search=MDAQ&catkey=manuals-amplifiers>

Internal Wiring

Notes

16 slot DEWE-MOTHERBOARD DAQ-MOTH-16-DE-x

Rear view

GND
 +15 V ORION
 -15 V ORION
 5 = 5 V output; 330 kHz filter
 10 = 10 V output; 330 kHz filter

16 channels single ended analog output (output resistance 15 Ohm)
 Please find the pin-assignment on the next page!

5 V ORION
 Ext. CLK
 Ext. TRIG
 DGND ORION
 Ext. CLK 2 OUT
 Ext. CLK 1 OUT (CAMERA TRIGGER)
 DGND ORION
 GND

16 x analog OUT (resistance 50 Ohm)
 16 x GND

W1 Terminate RS-485
 W2 Connect GND to GND_p
 W3 Connect +12 V to +V (pin 6)
 W4 Terminate RS-485
 W5 Connect chassis to GND
 W6 Connect chassis to GND
 W7 Connect chassis to GND
 W8 Activate ORION RS-485 (A)
 W9 Activate ORION RS-485 (B)
 W10 Activate analog output 0 on CH 14
 W11 Activate analog output 1 on CH 15

Note: If you connect signals to these contacts you have to open the solder jumpers W10 and W11 first!

Connection to CH14 (pin 7)
 Connection to CH15 (pin 7)

GND
 RES
 RS-232
 RS-485
 POWER
 DM
 DP
 GND_c
 TX
 RX
 GND_c
 TX
 RX
 GND_c
 A (RS-485)
 GND_c
 B (RS-485)
 GND_p
 +V
 +12 V
 +12 V
 -12 V
 -V

Front view

CH 0
 CH 1
 CH 2
 CH 3
 CH 4
 CH 5
 CH 6
 CH 7
 CH 8
 CH 9
 CH 10
 CH 11
 CH 12
 CH 13
 CH 14
 CH 15

Indicator
 +9 V
 -9 V

9-pin SUB-D pin assignment:

- 1 Module input (± 5 V)
- 2 RS-485 (A)
- 3 RS-485 (B)
- 4 GND
- 5 +9 V power supply
- 6 +12 V power (default) / +V sensor supply
- 7 Module output (from A/D board)
- 8 -V sensor supply
- 9 -9 V power supply

The 16 slot DEWE-MOTHERBOARD receives the ± 12 V_{DC} power supply via a DC/DC converter from the internal power supply.

Internal Wiring

Analog output connector pin-assignment

Connector for DEWE-ORION-1616 cards

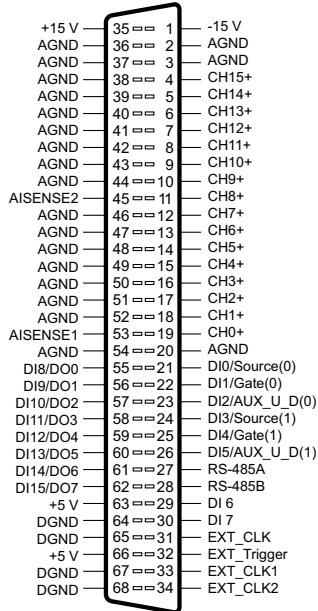

68-pin high density connector

Connector for DEWE-ORION-1624 cards

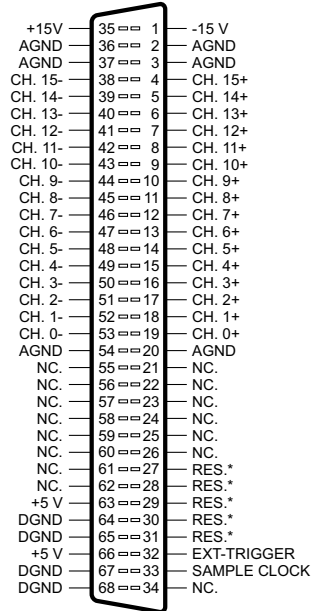

* DONT CONNECT

68-pin high density connector

16 slot DEWE-MOTHERBOARD DAQ-MOTH-16-NI-x-U

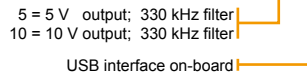

Connector for National Instruments™ A/D cards

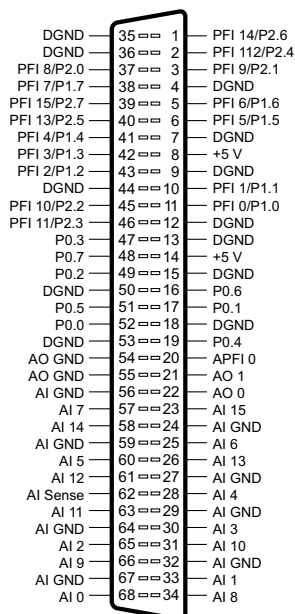

68-pin high density connector

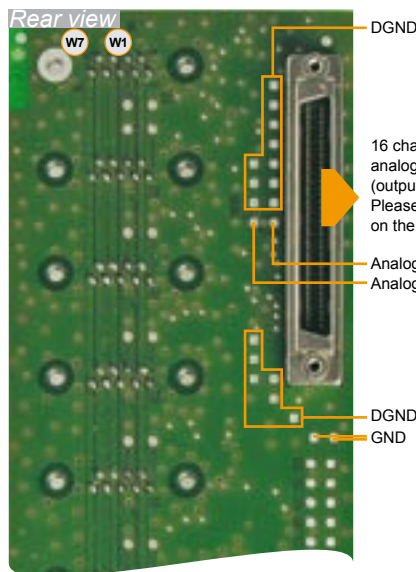

- W1 Terminate RS-485
- W2 Connect GND to GND_p
- W3 Connect +12 V to +V (pin 6)
- W4 Terminate RS-485
- W5 Connect chassis to GND
- W6 Connect chassis to GND
- W7 Connect chassis to GND

EC-Certificate of conformity

EC-Certificate of conformity

Manufacturer: **DEWETRON Elektronische Messgeraete Ges.m.b.H.**

Address: **Parkring 4
A-8074 Graz-Grambach Austria**

Tel.: +43 316 3070 0

Fax: +43 316 3070 90

e-mail: sales@dewetron.com

http://www.dewetron.com

Name of product:

DEWE-4012

Kind of product:

Portable instrument

The product meets the regulations of the following EC-directives:

73/23/EEC

"Directive on the approximation of the laws of the Member States relating to electrical equipment designed for use within certain voltage limits amended by the directive 93/68/EEC"

89/336/EEC

"Directive on the approximation of the laws of the Member States relating to electromagnetic compatibility amended by the directives 91/263/EEC, 92/31/EEC, 93/68/EEC and 93/97/EEC"

The accordance is proved by the observance of the following standards:

L V E M C	Safety	IEC/EN 61010-1:1992/93 IEC/EN 61010-2-031	IEC 61010-1:1992/300 V CATIII PoI. D. 2 IEC 1010-2-031
	Emissions	EN 61000-6-4	EN 55011 Class B
	Immunity	EN 61000-6-2	Group standard

Graz, April 25, 2008

Place / Date of the CE-marking

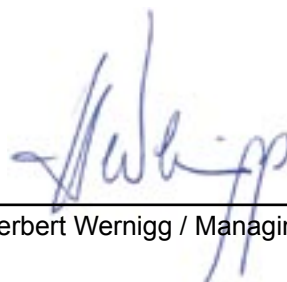

Ing. Herbert Wernigg / Managing director

Notes
