



Automotive
Energy & Power Analysis
Aerospace & Defense
Transportation
General Test & Measurement

DEWE-2010

Technical reference manual



Re-inventing Data Acquisition



Copyright © DEWETRON elektronische Messgeraete Ges.m.b.H.

This document contains information which is protected by copyright. All rights are reserved. Reproduction, adaptation, or translation without prior written permission is prohibited, except as allowed under the copyright laws.

All trademarks and registered trademarks are acknowledged to be the property of their owners.

Thank you!

Thank you very much for your investment in DEWETRON's unique data acquisition systems. These are top-quality instruments which are designed to provide you years of reliable service. This guide has been prepared to help you get the most from your investment, starting from the day you take it out of the box, and extending for years into the future.

This guide includes important startup notes, as well as safety notes and information about keeping your DEWETRON system in good working condition over time.

We strongly suggest that you read this entire manual, especially the safety and care sections, as well as to avoid damaging your DEWETRON system.

What is the DEWE-2010?

This product is used for measuring of different physical and/or electrical sizes (depending on model or configuration). The connection is depending on model or configuration and takes place via safety banana plugs, BNC connectors ($\pm 50V$ max.), D-SUB connectors ($\pm 50V$ max.), thermocouple connectors ($\pm 50V$ max.), BINDER® connectors ($\pm 50V$ max.) or LEMO® connectors.

Preface

Notes

Content

General Information, Safety Instructions	7
Training	7
Calibration.....	7
Support	7
Service/repairs	7
Warranty Information	8
Printing History.....	8
Safety symbols in the manual	9
General safety and hazard warnings for all DEWETRON systems	10
Windows updates and antivirus/security software	13
Problematic network stacks	13
Environmental Considerations	13
Blockdiagram of the internal signal processing	14
First steps	15
Main System	17
DEWE-2010 series PC instrument	17
System specifications	17
Connectors	18
Special Combustion Analyzer I/O connectors.....	21
A/D Conversion	A1
Internal Wiring	B1
CE-Certificate of conformity	C1

Table of content

Training

DEWETRON offers training at various offices around the world several times each year. DEWETRON headquarters in Austria have a very large and professional conference and seminar center, where training classes are conducted on a regular basis starting with sensors and signal conditioning, A/D technology and software operation. For more information about training services, please visit:
<http://www.dewetron.com/support/training>

Dewetron Inc. in the USA also has a dedicated training facility connected to its headquarters, located in Rhode Island. For more information about training services in the US, please visit:
<http://www.dewamerica.com/support/training>

Calibration

Every instrument needs to be calibrated at regular intervals. The standard norm across nearly every industry is annual calibration. Before your DEWETRON data acquisition system is delivered, it is calibrated at our DEWETRON headquarter. Each of this system is delivered with a certificate of compliance with our published specifications. Detailed calibration reports from our calibration system are available for purchase with each order. We retain them for at least one year, so calibration reports can be purchased for up to one year after your system was delivered.

Support

DEWETRON has a team of people ready to assist you if you have any questions or any technical difficulties regarding the system. For any support please contact your local distributor first or DEWETRON directly.

For Asia and Europe, please contact:

DEWETRON Ges.m.b.H.
Parkring 4
A-8074 Graz-Grambach
AUSTRIA
Tel.: +43 316 3070
Fax: +43 316 307090
Email: support@dewetron.com
Web: <http://www.dewetron.com>

The telephone hotline is available
Monday to Friday between
08:00 and 17:00 CET (GMT +1:00)

Service/repairs

The Team of DEWETRON also performs any kinds of repairs to your system to assure a safe and proper operation in future. For information regarding service and repairs please contact your local distributor first or DEWETRON directly.

For the Americas, please contact:

DEWETRON, Inc.
10 High Street, Suite K
Wakefield, RI 02879
U.S.A.
Tel.: +1 401 284 3750
Toll-free: +1 877 431 5166
Fax: +1 401 284 3755
Email: support@dewamerica.com
Web: <http://www.dewamerica.com>

The telephone hotline is available
Monday to Friday between
08:00 and 17:00 GST (GMT -5:00)

Notice

The information contained in this document is subject to change without notice.

DEWETRON elektronische Messgeraete Ges.m.b.H. (DEWETRON) shall not be liable for any errors contained in this document. DEWETRON MAKES NO WARRANTIES OF ANY KIND WITH REGARD TO THIS DOCUMENT, WHETHER EXPRESS OR IMPLIED. DEWETRON SPECIFICALLY DISCLAIMS THE IMPLIED WARRANTIES OF MERCHANTABILITY AND FITNESS FOR A PARTICULAR PURPOSE. DEWETRON shall not be liable for any direct, indirect, special, incidental, or consequential damages, whether based on contract, tort, or any other legal theory, in connection with the furnishing of this document or the use of the information in this document.

Warranty Information

A copy of the specific warranty terms applicable to your DEWETRON product and replacement parts can be obtained from your local sales and service office.

Restricted Rights Legend

Use austrian law for duplication or disclosure.

DEWETRON GesmbH
Parkring 4
A-8074 Graz-Grambach / Austria

Printing History

Please refer to the page bottom for printing version.

Copyright © DEWETRON elektronische Messgeraete Ges.m.b.H.

This document contains information which is protected by copyright. All rights are reserved. Reproduction, adaptation, or translation without prior written permission is prohibited, except as allowed under the copyright laws.

All trademarks and registered trademarks are acknowledged to be the property of their owners.

Safety instructions

Safety symbols in the manual



Indicates hazardous voltages.

WARNING *Calls attention to a procedure, practice, or condition that could cause bodily injury or death.*

CAUTION *Calls attention to a procedure, practice, or condition that could possibly cause damage to equipment or permanent loss of data.*

WARNINGS

The following general safety precautions must be observed during all phases of operation, service, and repair of this product. Failure to comply with these precautions or with specific warnings elsewhere in this manual violates safety standards of design, manufacture, and intended use of the product. DEWETRON Elektronische Messgeraete Ges.m.b.H. assumes no liability for the customer's failure to comply with these requirements.

All accessories shown in this document are available as option and will not be shipped as standard parts.



*For safety reasons max. 50 V may be applied to the BNC input-connectors!
Refer to the regulation of maximum allowable touch potential.*

Safety instructions

Your safety is our primary concern! Please be safe!

General safety and hazard warnings for all DEWETRON systems

- Use this system under the terms of the specifications only to avoid any possible danger.
- Maintenance will be executed by qualified staff only.
- During the use of the system, it might be possible to access another parts of a more comprehensive system. Please read and follow the safety instructions provided in the manuals of all other components regarding warning and security advices for using the system.
- With this product, only use the power cable delivered or defined for the host country.
- DO NOT connect or disconnect sensors, probes or test leads, as these parts are connected to a voltage supply unit.
- The system is grounded via a protective conductor in the power supply cord. To avoid electric shocks, the protective conductor has to be connected with the ground of the power network. Before connecting the input or output connectors of the system, make sure that there is a proper grounding to guarantee potential free usage. For countries, in which there is no proper grounding, please refer to your local legally safety regulations for safety use.

DC systems: Every DC system has a grounding connected to the chassis (yellow/green safety banana plug).

- Please note the characteristics and indicators on the system to avoid fire or electric shocks. Before connecting the system, please carefully read the corresponding specifications in the product manual.
- The inputs are not, unless otherwise noted (CATx identification), for connecting to the main circuit of category II, III and IV.
- The power cord separates the system from the power supply. Do not block the power cord, since it has to be accessible for the users.
- DO NOT use the system if equipment covers or shields are removed.
- If you assume the system is damaged, get it examined by authorised personnel only.
- Any use in wet rooms, outdoors or in adverse environmental condition is not allowed!
Adverse environmental conditions are:
 - Moisture or high humidity
 - Dust, flammable gases, fumes or dissolver
 - Thunderstorm or thunderstorm conditions (except assembly PNA)
 - Electrostatic fields, et cetera.
- The measurement category can be adjusted depending on module configuration.
- Any direct voltage output is protected with a fuse against short cut and reverse-polarity, but is NOT galvanically isolated (except it is explicit marked on the system).
- The system must be connected and operated to an earthed wall socket at the AC mains power supply only (except for DC systems).
- Any other use than described above may damage your system and is attended with dangers like shortcut, fire or electric shocks.
- The whole system must not be changed, rebuilt or opened (except for changing DAQ, DAQP, PAD modules).

Safety instructions

- If you assume a more riskless use is not provided anymore, the system has to be rendered inoperative and should be protected against inadvertent operation. It is assumed that a more riskless operation is not possible anymore, if
 - the system is damaged obviously or causes strange noises.
 - the system does not work anymore.
 - the system has been exposed to long storage in adverse environmental.
 - the system has been exposed to heavy shipment strain.
 - DO NOT touch any exposed connectors or components if they are live wired. The use of metal bare wires is not allowed. There is a risk of short cut and fire hazard!
 - Warranty void if damages caused by disregarding this manual. For consequential damages NO liability will be assumed!
 - Warranty void if damages to property or persons caused by improper use or disregarding the safety instructions.
 - Unauthorized changing or rebuilding the system is prohibited due to safety and permission reasons (CE). Exception: changing modules like DAQ, DAQP or PAD.
 - The assembly of the system is equivalent to protection class I. For power supply, only the correct power socket of the public power supply must be used, except the system is DC powered.
 - Be careful with voltages >25 VAC or >35 VDC! These voltages are already high enough in order to get a perilous electric shock by touching the wiring.
 - The product heats during operation. Make sure there is adequate ventilation. Ventilation slots must not covered!
 - Only fuses of the specified type and nominal current may be used. The use of patched fuses is prohibited.
 - Prevent using metal bare wires! Risk of short cut and fire hazard!
 - DO NOT use the system before, during or shortly after a thunderstorm (risk of lightning and high energy overvoltage). An advanced range of application under certain conditions is allowed with therefore designed products only. For details please refer to the specifications.
 - Make sure that your hands, shoes, clothes, the floor, the system or measuring leads, integrated circuits and so on, are dry.
 - DO NOT use the system in rooms with flammable gases, fumes or dust or in adverse environmental conditions.
 - Avoid operation in the immediate vicinity of:
 - high magnetic or electromagnetic fields
 - transmitting antennas or high-frequency generators
- For exact values please refer to enclosed specifications.
- Use measurement leads or measurement accessories aligned to the specification of the system only. Fire hazard in case of overload!
 - Do not switch on the system after transporting it from a cold into a warm room and vice versa. The thereby created condensation may damage your system. Acclimatise the system unpowered to room temperature.
 - Do not disassemble the system! There is a high risk of getting a perilous electric shock. Capacitors still might be charged, even the system has been removed from the power supply.
 - The electrical installations and equipments in industrial facilities must be observed by the security regulations and insurance institutions.

Safety instructions

- The use of the measuring system in schools and other training facilities must be observed by skilled personnel.
- The measuring systems are not designed for use at humans and animals.
- Please contact a professional if you have doubts about the method of operation, safety or the connection of the system.
- Please be careful with the product. Shocks, hits and dropping it from already lower level may damage your system. For exact values please refer to enclosed specifications.
- Please also consider the detailed technical reference manual as well as the security advices of the connected systems.

This product has left the factory in safety-related flawless and proper condition.

In order to maintain this condition and guarantee safety use, the user has to consider the security advices and warnings in this manual.

EN 61326-3-1:2008

IEC 61326-1 applies to this part of IEC 61326 but is limited to systems and equipment for industrial applications intended to perform safety functions as defined in IEC 61508 with SIL 1-3.

The electromagnetic environments encompassed by this product family standard are industrial, both indoor and outdoor, as described for industrial locations in IEC 61000-6-2 or defined in 3.7 of IEC 61326-1. Equipment and systems intended for use in other electromagnetic environments, for example, in the process industry or in environments with potentially explosive atmospheres, are excluded from the scope of this product family standard, IEC 61326-3-1.

Devices and systems according to IEC 61508 or IEC 61511 which are considered as “operationally well-tried”, are excluded from the scope of IEC 61326-3-1.

Fire-alarm and safety-alarm systems, intended for protection of buildings, are excluded from the scope of IEC 61326-3-1.

CAUTION

- The system BIOS is protected by password. Any change in the BIOS may cause a system crash. When the system is booting, do not press ESC-button on keyboard. This may clear the BIOS settings and cause system faults.
- Any change in the file structure as deleting or adding files or directories might cause a system crash.
- Before installing software updates contact DEWETRON or your local distributor. Use only software packages which are released by DEWETRON. Further informations are also available in the internet (<http://www.dewetron.com>).
- After power off the system wait at least 10 seconds before switching the system on again. Otherwise the system may not boot correct. This prolongs also the life of all system components.

Windows updates and antivirus/security software

Before installing Windows software updates consult with DEWETRON for compatibility guidance. Please also keep in mind that the use of any antivirus or other security software may slow down your system and may cause data loss.

Problematic network stacks

Often intrusive IT software or network processes can interfere with the primary function of the DEWETRON system: to record data. Therefore we recommend strongly against the installation of IT/MIS software and running their processes on any DEWETRON data acquisition system, and cannot guarantee the performance of our systems if they are so configured.



Environmental Considerations

Information about the environmental impact of the product.

Product End-of-Life Handling

Observe the following guidelines when recycling a DEWETRON system:

System and Components Recycling

Production of these components required the extraction and use of natural resources. The substances contained in the system could be harmful to your health and to the environment if the system is improperly handled at its end of life! Please recycle this product in an appropriate way to avoid an unnecessary pollution of the environment and to keep natural resources.

This symbol indicates that this system complies with the European Union's requirements according to Directive 2002/96/EC on waste electrical and electronic equipment (WEEE). Please find further informations about recycling on the DEWETRON web site www.dewetron.com

Restriction of Hazardous Substances

This product has been classified as Monitoring and Control equipment, and is outside the scope of the 2002/95/EC RoHS Directive. This product is known to contain lead.

Signal processing

Blockdiagram of the internal signal processing

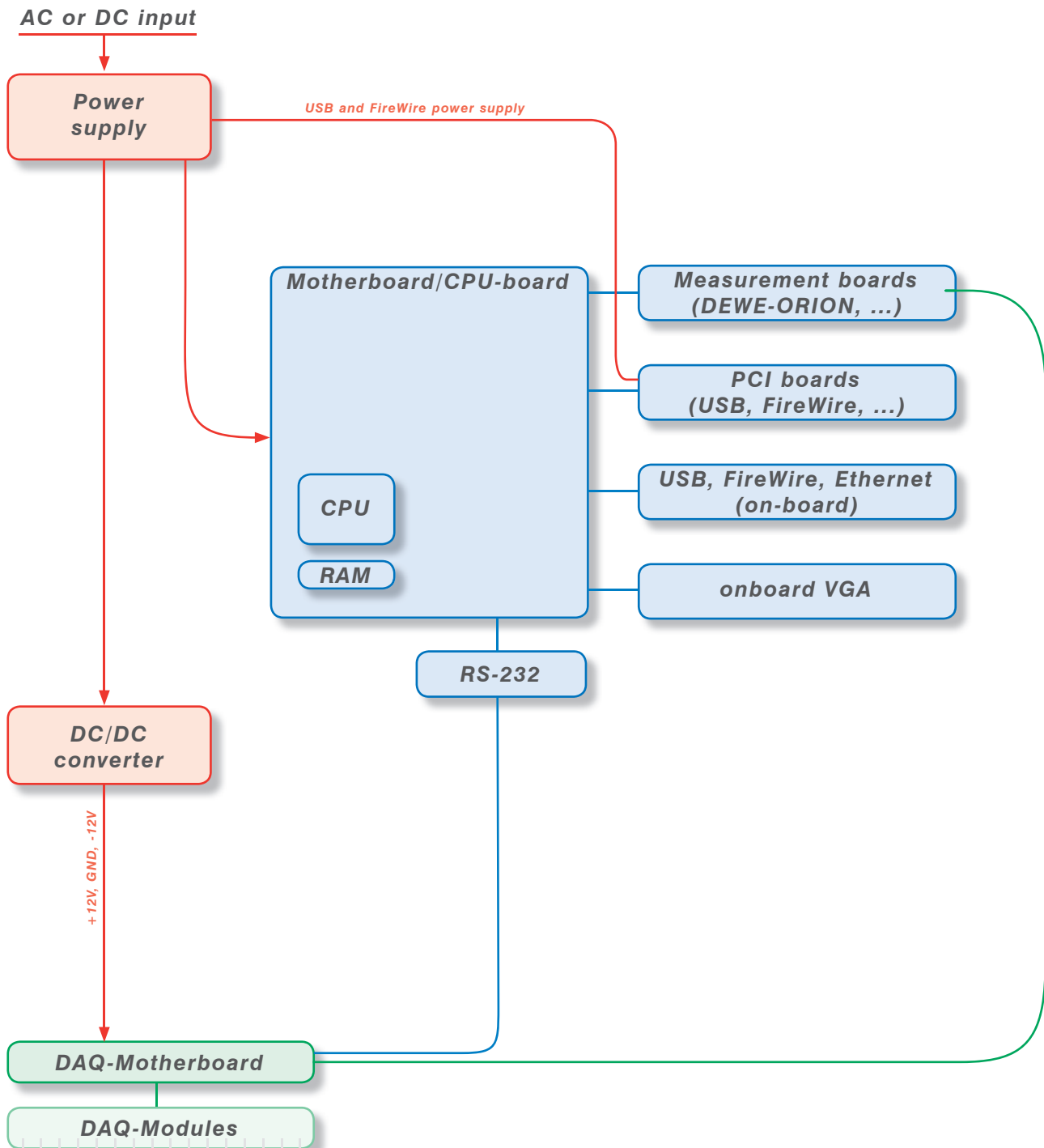

First steps

1



Power-on your system.

2

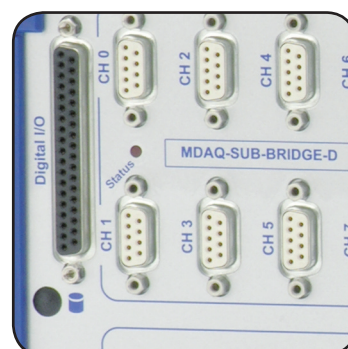

Connect your sensors to the system.

3

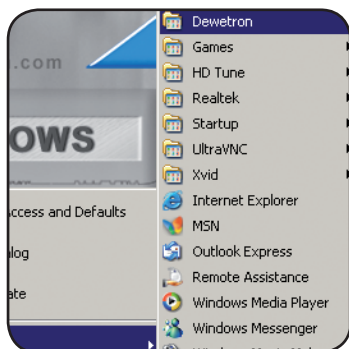

Run DEWESoft usually via "Start" > "Programs" > "Dewetron" > "DEWESoft x.x" > "DEWESoft x.x"

4

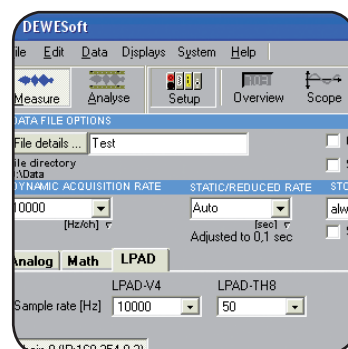

Start recording your data!

First steps

Notes

DEWE-2010 series PC instrument

- Portable data acquisition system
- Up to 16 channels with isolation
(in conjunction with DEWE-DAQ modules)
- Up to 256 channels with external
expansion racks
- A/D converter specs see appendix A

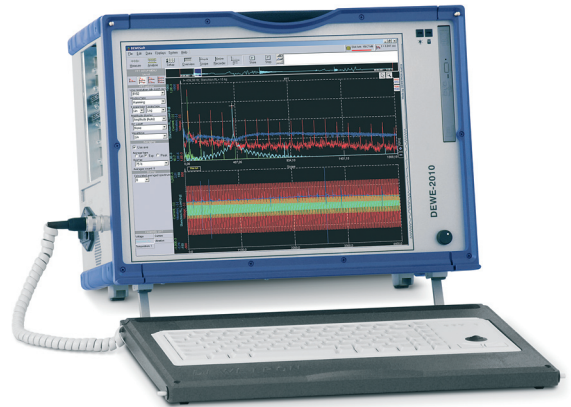

System specifications

	DEWE-2010
Power supply:	<input type="checkbox"/> 300 W AC power supply 'FSP300-601U' <input type="checkbox"/> AC/DC multi power supply 'NET-202 + Accu' for details see next pages
Operating temperature:	-5 °C to 50 °C (standard)
Storage temperature:	-20 °C to +70 °C
Humidity (operating):	10 % to 80 %, non condensing 5 % to 95 %, rel. humidity
Vibration:	MIL-STD 810F 514.5 procedure I operating test procedure frequency range: 5 to 200 to 5 Hz; 5 x 12 min each direction displacement amplitude ±3.5 mm (5 to 8.45 Hz) acceleration amplitude 1 g (8.45 to 92 Hz) displacement amplitude 92 to 113 Hz: ±0.029 mm acceleration amplitude 1.5 g (113 to 200 Hz)
Shock:	MIL-STD 810F 516.5 procedure I non operating test procedure ½ sinus 11 ms 10 g, 3 shocks positive, 3 shocks negative
Dimensions (W x H x D):	approx. 410 x 288 x 205 mm (16.1 x 11.3 x 8.1 in.)
Weight:	typ. 9.5 kg (19 lbs), depending on configuration

Dimensions*

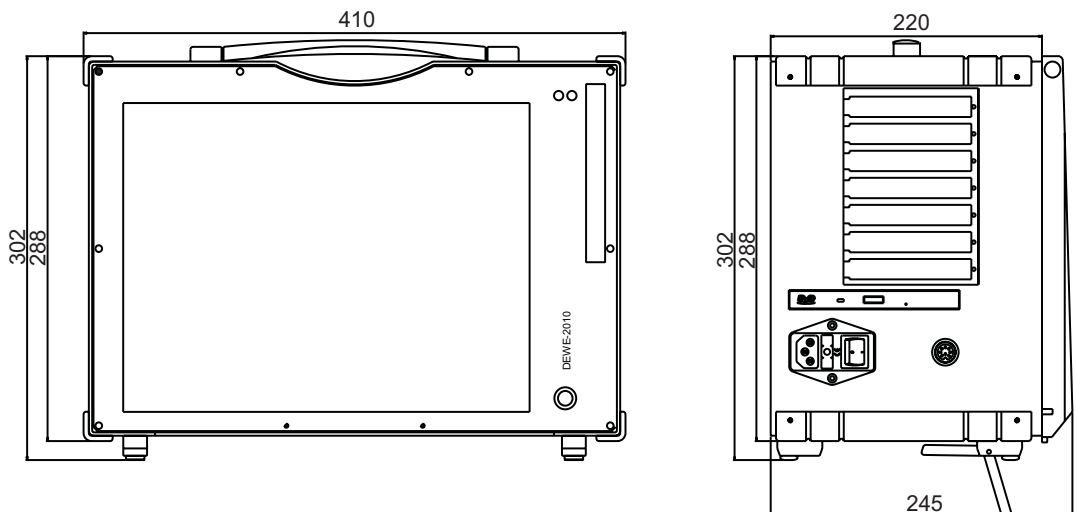

* Dimensions in mm
(1 inch = 25.4 mm)

Main System

Connectors



Typical DEWE-2010 rear view

Connector overview:

1. Power supply connector
2. Keyboard connector
3. RS-232 interface connectors (2x)
4. USB interface connectors (2x)
5. VGA connector
6. Power supply internal rack (inside system, not shown)
7. Combustion analyzer connectors (optional)

Note: The location of the connectors might vary from system to system and depends on system configuration

Power supply connector

The system fuse for AC power supply is located between connector and power switch. If the system doesn't work after switching on, disconnect the power cord and check the fuse.

300W AC power supply

300 W AC power supply	FSP300-601U
Input:	
Input range:	100 to 240 V _{AC} (auto selecting)
Input frequency:	50 / 60 Hz
Max. input current:	3 A to 6 A
Output:	
Output power:	300 W max.
Output voltages:	+3.3 V (max. 20 A)*
	+5 V (max. 25 A)* -5 V (max. 0.3 A)
	+12 V (max. 16 A) -12V (max. 0.8 A)
	+5 Vsb (max. 2 A)

Note: The max. load of +3.3 V and +5 V together is 157 W, otherwise power supply will be damaged.

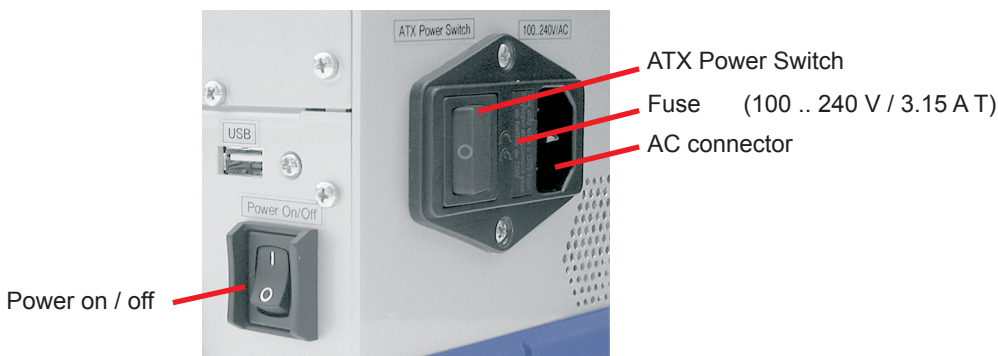

AC/DC multi power supply

AC/DC Power supply	NET-202 + Accu
Input:	
AC input:	90 to 260 V _{AC} / 45 to 400 Hz
DC and battery input:	10 to 32 V _{DC}
Max. input current:	3.5 A (230 V _{AC}) Startup peak up to 25 A
Input power:	160 W
Input voltage priority:	1. AC voltage 2. DC voltage 3. Battery
Battery type:	NiCd, 24 V _{DC} , 600 mAh
Output:	
Output power:	160 W
Output voltages:	+5 V (max. 20 A) -5 V (max. 0.3 A) +12 V (max. 5 A) -12 V (max. 0.4 A)
Power LED:	
dim green:	AC and / or DC connected to system, system powered off
bright green:	AC and / or DC connected to system, system powered on
orange:	system powered on, working via accu
red:	starts 30 sec. before accu is getting low together with beep signal

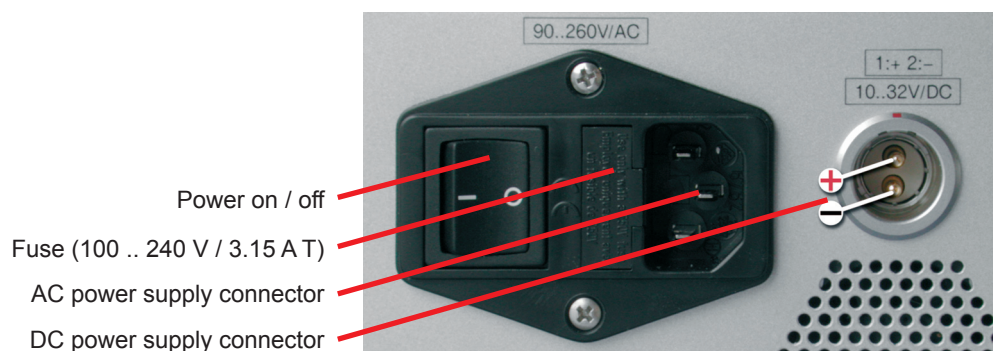

Main System

Keyboard connector

The keyboard connector is designed to use the DEWE-2010 system keyboard as well as standard keyboards with the standard 5-pin DIN connector.



8-pin DIN connector

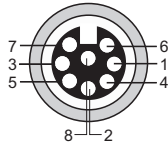

Schematic

Pin assignment

- 1: Keyboard CLK
- 2: Keyboard DATA
- 3: Mouse DATA
- 4: Keyboard and Mouse GND
- 5: Keyboard Vcc
- 6: Mouse Vcc
- 7: Mouse CLK
- 8: Not connected

USB interface connectors (Universal Serial Bus)

The USB interface connectors meets standard USB pin assignment.

RS-232 interface connector (COM1)

The RS-232 interface connector (male) is located on the left side of the DEWE-2010. It is configured as standard RS-232 interface COM 1 and can be used for mouse or other peripheral units.

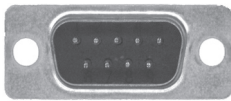

9-pin SUB-D connector (male)

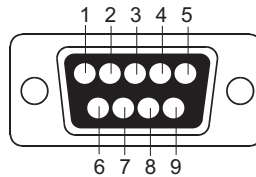

Schematic

Pin assignment

- 1: DCD (Data Carrier Detector)
- 2: RD (Received Data)
- 3: TD (Transmitted Data)
- 4: DTR (Data Terminal Ready)
- 5: GND (Ground)
- 6: DSR (Data Set Ready)
- 7: RTS (Request To Send)
- 8: CTS (Clear To Send)
- 9: RI (Ring Indicator)

VGA connector

The VGA connector offers the possibility to connect an external CRT or other standard VGA displays to the system.

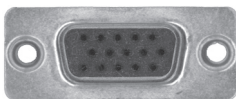

15-pin mini-SUB-D connector (male)

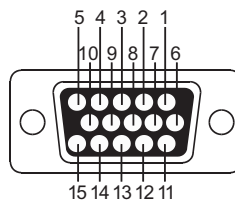

Schematic

Pin assignment

- 1: Red video
- 2: Green video / Sync on green
- 3: Blue video
- 4: -
- 5: -
- 6: Red video ground
- 7: Green video ground
- 8: Blue video ground
- 9: -
- 10: Ground
- 11: Ground
- 12: Data line
- 13: H-Sync / HV-Sync
- 14: V-Sync
- 15: Clock line

Ethernet connector

The DEWE-2010 system supports 10/100 BaseT Ethernet with standard RJ45 connector.

Power-on button

The power-on button has to be used to switch on the system. It only works when the main power switch is on.

Power supply backplane / cooling fan

The AMP connector is the internal power supply connection to the internal rack and the cooling fan, mounted on the backplane of the DEWE-2010 system.

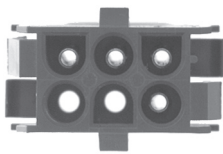

6-pin AMP connector

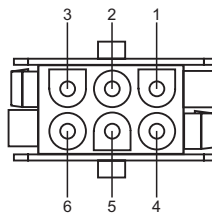

Schematic

Pin assignment

- 1: +12 V
- 2: GND
- 3: +5 V
- 4: -12 V
- 5: GND (EPAD supply)
- 6: +12 V (EPAD supply)

Ground connectors

For some kind of measurements, it's necessary to give the system an additional ground connection.

Special Combustion Analyzer I/O connectors

The Combustion Analyzer requires several special input signals to work. Please refer to appendix B (wirings) for details.

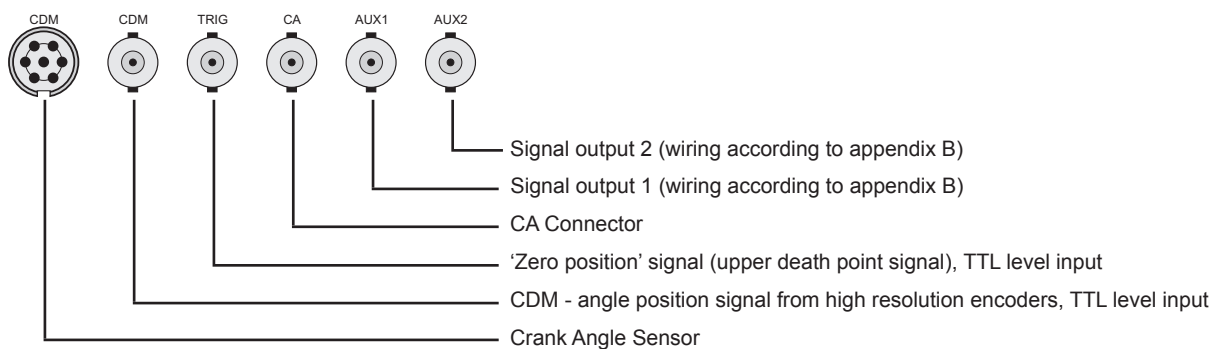

Main System

Notes

A/D & D/A Conversion

A/D Conversion

Please find information about the A/D conversion in the attached DEWE-ORION series manual. The latest version of the manual can be downloaded from:

<http://download.dewetron.com/dl/components/adboards>

Informations regarding different manufacturer's see the corresponding D/A card manual.

A/D & D/A Conversion

Notes

16 slot DEWE-MOTHERBOARD DAQ-MOTH-16-DE-x

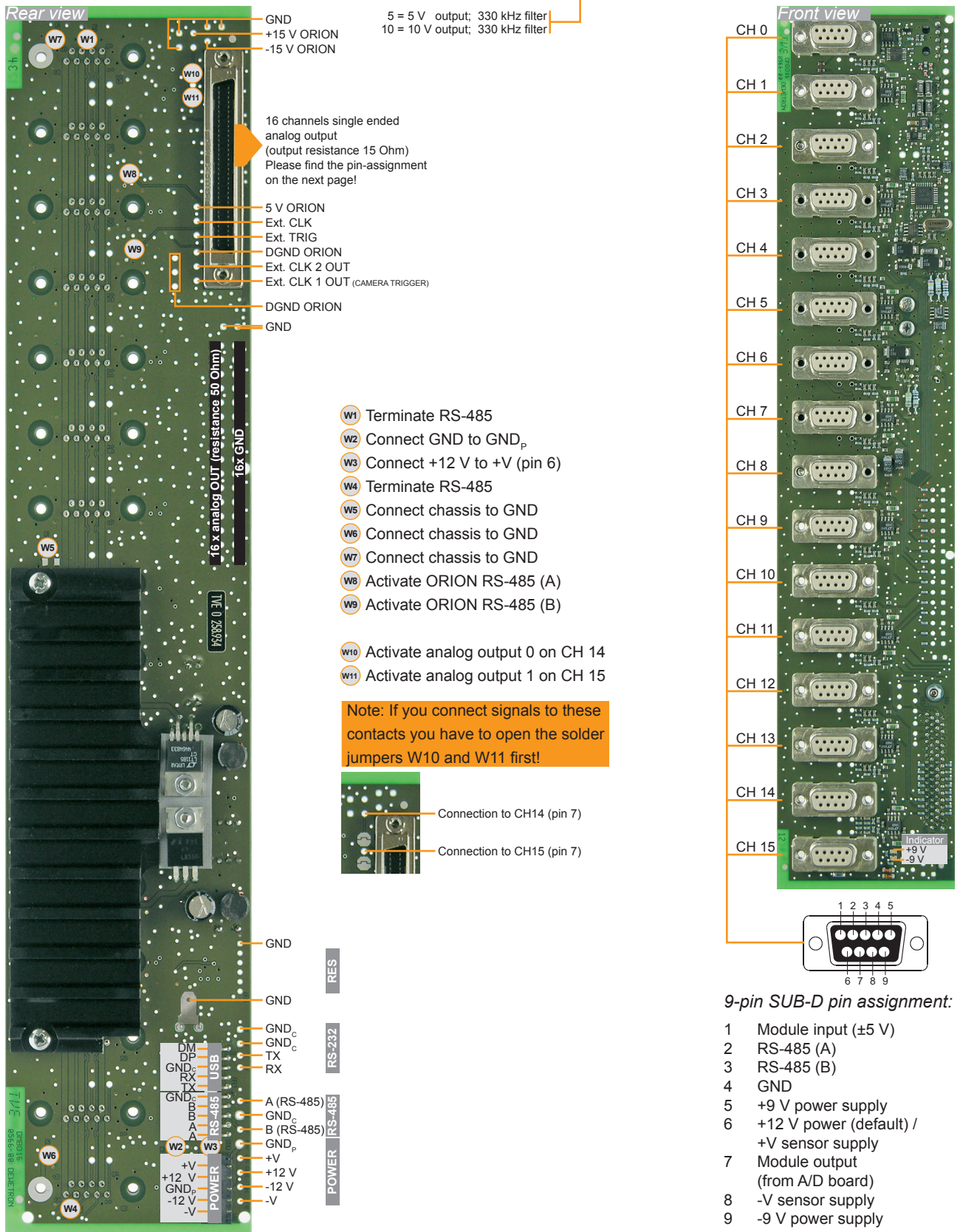

The 16 slot DEWE-MOTHERBOARD receives the ± 12 V_{DC} power supply via a DC/DC converter from the internal power supply.

Internal Wiring

Analog output connector pin-assignment

Connector for DEWE-ORION-1616 cards

+15 V	35 == 1	-15 V
AGND	36 == 2	AGND
AGND	37 == 3	AGND
AGND	38 == 4	CH15+
AGND	39 == 5	CH14+
AGND	40 == 6	CH13+
AGND	41 == 7	CH12+
AGND	42 == 8	CH11+
AGND	43 == 9	CH10+
AGND	44 == 10	CH9+
AISENSE2	45 == 11	CH8+
AGND	46 == 12	CH7+
AGND	47 == 13	CH6+
AGND	48 == 14	CH5+
AGND	49 == 15	CH4+
AGND	50 == 16	CH3+
AGND	51 == 17	CH2+
AGND	52 == 18	CH1+
AISENSE1	53 == 19	CH0+
AGND	54 == 20	AGND
DI8/DO0	55 == 21	DI0/Source(0)
DI9/DO1	56 == 22	DI1/Gate(0)
DI10/DO2	57 == 23	DI2/AUX_U_D(0)
DI11/DO3	58 == 24	DI3/Source(1)
DI12/DO4	59 == 25	DI4/Gate(1)
DI13/DO5	60 == 26	DI5/AUX_U_D(1)
DI14/DO6	61 == 27	RS-485A
DI15/DO7	62 == 28	RS-485B
+5 V	63 == 29	DI 6
DGND	64 == 30	DI 7
DGND	65 == 31	EXT_CLK
+5 V	66 == 32	EXT_Trigger
DGND	67 == 33	EXT_CLK1
DGND	68 == 34	EXT_CLK2

68-pin high density connector

Connector for DEWE-ORION-1624 cards

+15V	35 == 1	-15 V
AGND	36 == 2	AGND
AGND	37 == 3	AGND
CH. 15-	38 == 4	CH. 15+
CH. 14-	39 == 5	CH. 14+
CH. 13-	40 == 6	CH. 13+
CH. 12-	41 == 7	CH. 12+
CH. 11-	42 == 8	CH. 11+
CH. 10-	43 == 9	CH. 10+
CH. 9-	44 == 10	CH. 9+
CH. 8-	45 == 11	CH. 8+
CH. 7-	46 == 12	CH. 7+
CH. 6-	47 == 13	CH. 6+
CH. 5-	48 == 14	CH. 5+
CH. 4-	49 == 15	CH. 4+
CH. 3-	50 == 16	CH. 3+
CH. 2-	51 == 17	CH. 2+
CH. 1-	52 == 18	CH. 1+
CH. 0-	53 == 19	CH. 0+
AGND	54 == 20	AGND
NC.	55 == 21	NC.
NC.	56 == 22	NC.
NC.	57 == 23	NC.
NC.	58 == 24	NC.
NC.	59 == 25	NC.
NC.	60 == 26	NC.
NC.	61 == 27	RES.*
NC.	62 == 28	RES.*
+5 V	63 == 29	RES.*
DGND	64 == 30	RES.*
DGND	65 == 31	RES.*
+5 V	66 == 32	EXT-TRIGGER
DGND	67 == 33	SAMPLE CLOCK
DGND	68 == 34	NC.

* DONT CONNECT

68-pin high density connector

16 slot DEWE-MOTHERBOARD DAQ-MOTH-16-NI-x-U

5 = 5 V output; 330 kHz filter
 10 = 10 V output; 330 kHz filter
 USB interface on-board

Connector for National Instruments™ A/D cards

DGND	35 == 1	PFI 14/P2.6
DGND	36 == 2	PFI 112/P2.4
PFI 8/P2.0	37 == 3	PFI 9/P2.1
PFI 7/P1.7	38 == 4	DGND
PFI 15/P2.7	39 == 5	PFI 6/P1.6
PFI 13/P2.5	40 == 6	PFI 5/P1.5
PFI 4/P1.4	41 == 7	DGND
PFI 3/P1.3	42 == 8	+5 V
PFI 2/P1.2	43 == 9	DGND
DGND	44 == 10	PFI 1/P1.1
PFI 10/P2.2	45 == 11	PFI 0/P1.0
PFI 11/P2.3	46 == 12	DGND
P0.3	47 == 13	DGND
P0.7	48 == 14	+5 V
P0.2	49 == 15	DGND
DGND	50 == 16	P0.6
P0.5	51 == 17	P0.1
P0.0	52 == 18	DGND
DGND	53 == 19	P0.4
AO GND	54 == 20	APFI 0
AO GND	55 == 21	AO 1
AI GND	56 == 22	AO 0
AI 7	57 == 23	AI 15
AI 14	58 == 24	AI GND
AI GND	59 == 25	AI 6
AI 5	60 == 26	AI 13
AI 12	61 == 27	AI GND
AI Sense	62 == 28	AI 4
AI 11	63 == 29	AI GND
AI GND	64 == 30	AI 3
AI 2	65 == 31	AI 10
AI 9	66 == 32	AI GND
AI GND	67 == 33	AI 1
AI 0	68 == 34	AI 8

68-pin high density connector

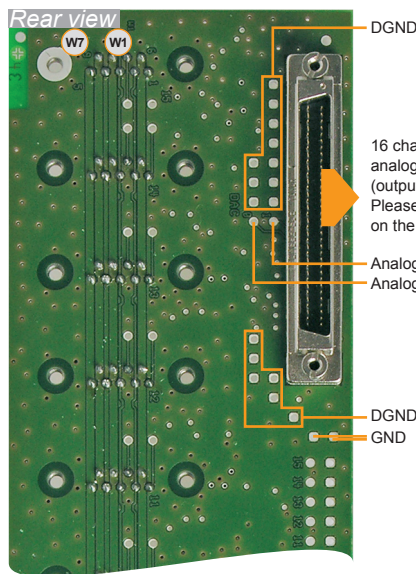

- W1 Terminate RS-485
- W2 Connect GND to GND_p
- W3 Connect +12 V to +V (pin 6)
- W4 Terminate RS-485
- W5 Connect chassis to GND
- W6 Connect chassis to GND
- W7 Connect chassis to GND

CE-Certificate of conformity



Manufacturer:

DEWETRON Elektronische Messgeraete Ges.m.b.H.

Address:

**Parkring 4
A-8074 Graz-Grambach Austria**

Tel.: +43 316 3070 0

Fax: +43 316 3070 90

e-mail: sales@dewetron.com

http://www.dewetron.com

Name of product:

DEWE-2010

Kind of product:

Data acquisition instrument

The product meets the regulations of the following EC-directives:

73/23/EEC

"Directive on the approximation of the laws of the Member States relating to electrical equipment designed for use within certain voltage limits amended by the directive 93/68/EEC"

89/336/EEC

"Directive on the approximation of the laws of the Member States relating to electromagnetic compatibility amended by the directives 91/263/EEC, 92/31/EEC, 93/68/EEC and 93/97/EEC"

The accordance is proved by the observance of the following standards:

L V E M C	Safety	IEC/EN 61010-1:1992/93 IEC/EN 61010-2-031	IEC 61010-1:1992/300 V CATIII PoI. D. 2 IEC 1010-2-031
	Emissions	EN 61000-6-4	EN 55011 Class B
	Immunity	EN 61000-6-2	Group standard

Graz, October 14, 2008

Place / Date of the CE-marking

Dipl.-Ing. Roland Jeutter / Managing director

Notes
