



Automotive  
Energy & Power Analysis  
Field Service  
Environmental  
Research & Development

# DEWE-41-T-DSA

*Technical reference manual*



ISO9001

... the precision signal conditioning company



Copyright © DEWETRON elektronische Messgeraete Ges.m.b.H.

This document contains information which is protected by copyright. All rights are reserved. Reproduction, adaptation, or translation without prior written permission is prohibited, except as allowed under the copyright laws.

All trademarks and registered trademarks are acknowledged to be the property of their owners.

## Content

<b>General Information, Safety Instructions</b>	<b>5</b>
Warranty Information .....	5
Support .....	5
Printing History.....	5
Safety symbols in the manual .....	6
Safety instructions for all DEWETRON systems .....	7
Environmental Considerations .....	8
<b>DEWE-41-T-DSA</b>	<b>9</b>
Specifications .....	9
Possible system configuration .....	10
Connection .....	10
Tachometer input.....	11
Internal wiring of the DT9837 module .....	12
Installation of DEWESoft 6.4 .....	13
Installation of the DEWE-41-T-DSA drivers.....	14
Hardware setup in DEWESoft .....	17

# Technical Reference

---

The information contained in this document is subject to change without notice.

DEWETRON elektronische Messgeraete Ges.m.b.H. (DEWETRON) shall not be liable for any errors contained in this document. DEWETRON MAKES NO WARRANTIES OF ANY KIND WITH REGARD TO THIS DOCUMENT, WHETHER EXPRESS OR IMPLIED. DEWETRON SPECIFICALLY DISCLAIMS THE IMPLIED WARRANTIES OF MERCHANTABILITY AND FITNESS FOR A PARTICULAR PURPOSE. DEWETRON shall not be liable for any direct, indirect, special, incidental, or consequential damages, whether based on contract, tort, or any other legal theory, in connection with the furnishing of this document or the use of the information in this document.

## Warranty Information

A copy of the specific warranty terms applicable to your DEWETRON product and replacement parts can be obtained from your local sales and service office.

## Support

For any support please contact your local distributor first or DEWETRON directly.

For Asia and Europe, please contact:

DEWETRON Ges.m.b.H.  
Parkring 4  
A-8074 Graz-Grambach  
AUSTRIA  
Tel.: +43 316 3070  
Fax: +43 316 307090  
Email: [support@dewetron.com](mailto:support@dewetron.com)  
Web: <http://www.dewetron.com>

The telephone hotline is available  
Monday to Friday between  
08:00 and 17:00 CET (GMT +1:00)

For the Americas, please contact:

DEWETRON, Inc.  
10 High Street, Suite K  
Wakefield, RI 02879  
U.S.A.  
Tel.: +1 401 284 3750  
Toll-free: +1 877 431 5166  
Fax: +1 401 284 3755  
Email: [support@dewamerica.com](mailto:support@dewamerica.com)  
Web: <http://www.dewamerica.com>

The telephone hotline is available  
Monday to Friday between  
08:00 and 17:00 GST (GMT -5:00)

## Restricted Rights Legend

Use austrian law for duplication or disclosure.

DEWETRON GesmbH  
Parkring 4  
A-8074 Graz-Grambach / Austria

## Printing History

Please refer to the page bottom for printing version.

Copyright © DEWETRON elektronische Messgeraete Ges.m.b.H.

This document contains information which is protected by copyright. All rights are reserved. Reproduction, adaptation, or translation without prior written permission is prohibited, except as allowed under the copyright laws.

All trademarks and registered trademarks are acknowledged to be the property of their owners.

# Safety instructions

---

## Safety symbols in the manual

---



*Indicates hazardous voltages.*

---

**WARNING** *Calls attention to a procedure, practice, or condition that could cause bodily injury or death.*

---

**CAUTION** *Calls attention to a procedure, practice, or condition that could possibly cause damage to equipment or permanent loss of data.*

---

### **WARNINGS**

*The following general safety precautions must be observed during all phases of operation, service, and repair of this product. Failure to comply with these precautions or with specific warnings elsewhere in this manual violates safety standards of design, manufacture, and intended use of the product. DEWETRON Elektronische Messgeraete Ges.m.b.H. assumes no liability for the customer's failure to comply with these requirements.*

---

**All accessories shown in this document are available as option and will not be shipped as standard parts.**



*For safety reasons max. 50 V may be applied to the BNC input-connectors!  
Refer to the regulation of maximum allowable touch potential.*

---

## Safety instructions for all DEWETRON systems

- The DEWETRON data acquisition systems may only be installed by experts.
- Read your manual before operating the system.
- Observe local laws when using the instrument.
- Ground the equipment: For Safety Class 1 equipment (equipment having a protective earth terminal), a non interruptible safety earth ground must be provided from the mains power source to the product input wiring terminals or supplied power cable.
- DO NOT operate the product in an explosive atmosphere or in the presence of flammable gases or fumes and do not bring the system in contact with water.
- DO NOT operate damaged equipment: Whenever it is possible that the safety protection features built into this product have been impaired, either through physical damage, excessive moisture, or any other reason, REMOVE POWER and do not use the product until safe operation can be verified by service-trained personnel. If necessary, return the product to a DEWETRON sales and service office for service and repair to ensure that safety features are maintained.
- Keep away from live circuits: Operating personnel must not remove equipment covers or shields. Procedures involving the removal of covers or shields are for use by service-trained personnel only. Under certain conditions, dangerous voltages may exist even with the equipment switched off. To avoid dangerous electrical shock, DO NOT perform procedures involving cover or shield removal unless you are qualified to do so.
- No modifications are allowed at the instrument. The fuse in the power module has to be replaced by the same type. For continued protection against fire, replace the line fuse(s) only with fuse(s) of the same voltage and current rating and type. DO NOT use repaired fuses or short-circuited fuse holder labels and print on the power module may not be removed.
- DO NOT service or adjust alone. Do not attempt internal service or adjustment unless another person, capable of rendering first aid and resuscitation, is present.
- DO NOT substitute parts or modify equipment: Because of the danger of introducing additional hazards, do not install substitute parts or perform any unauthorized modification to the product. Return the product to a DEWETRON sales and service office for service and repair to ensure that safety features are maintained.
- Before opening the instrument (experts only) or exchanging the fuse in the power module disconnect power!
- Don't touch internal wiring!
- Don't use higher supply voltage than specified and take care of the correct polarity, otherwise the system will be damaged!
- Use only original plugs and cables for harnessing.
- Install filler-panels in unused slots.
- The power-cable and -connector serve as Power-Breaker. The cable must not exceed 10 feet, disconnect function must be possible without tools.
- Keep the ventilation slots free and check them frequently to avoid an overheating of the system. The cleaning interval of the filter pads depends on the environmental conditions.
- Safety of the operator and the unit depend on following these rules.
- DEWETRON is not responsible for any damage or injury that could result from improper connection or misuse!

# General Information

---

## **CAUTION**

- The system BIOS is protected by password. Any change in the BIOS may cause a system crash. When the system is booting, do not press ESC-button on keyboard. This may clear the BIOS settings and cause system faults.
- Any change in the file structure as deleting or adding files or directories might cause a system crash.
- Before installing software updates contact DEWETRON or your local distributor. Use only software packages which are released by DEWETRON. Further informations are also available in the internet (<http://www.dewetron.com>).
- After power off the system wait at least 10 seconds before switching the system on again. Otherwise the system may not boot correct. This prolongs also the life of all system components.

## **Environmental Considerations**

Information about the environmental impact of the product.

### **Product End-of-Life Handling**

Observe the following guidelines when recycling a DEWETRON system:

### **System and Components Recycling**

Production of these components required the extraction and use of natural resources. The substances contained in the system could be harmful to your health and to the environment if the system is improperly handled at it's end of life! Please recycle this product in an appropriate way to avoid an unnecessary pollution of the environment and to keep natural resources.



This symbol indicates that this system complies with the European Union's requirements according to Directive 2002/96/EC on waste electrical and electronic equipment (WEEE). Please find further informations about recycling on the DEWETRON web site [www.dewetron.com](http://www.dewetron.com)



### **Restriction of Hazardous Substances**

This product has been classified as Monitoring and Control equipment, and is outside the scope of the 2002/95/EC RoHS Directive. This product is known to contain lead.

## 4 channel handheld digital signal analyzer

### Features:

- 4 simultaneously sampled analog inputs and 1 tachometer input
- 24-bit resolution; 102 dB dynamic range
- 52.7 kS/s maximum sampling rate
- Voltage or ICP® input per channel
- ±1 and ±10 V input range
- AC / DC coupling
- USB 2.0 Hi-Speed



## Specifications

DEWE-41-T-DSA			
<b>Input Characteristics</b>		<b>Standards</b>	
<b>Analog Input</b>		EMI	
Number of analog input channels	4, single-ended, simultaneous	FCC part 15, class A EN 55022:1994	
ADC resolution	24-bit	EN 50082-1:1998	
Type of ADC	Delta-sigma	IEC 801-2:1984	
Sample rate	Min. 195.3 S/s, max. 52.734 kS/s	IEC 801-3	
Group delay	38 / output frequency	IEC 801-4	
Ranges and gains	±10 V (gain of 1), ±1 V (gain of 10)	8 kV air / 4 kV contact 3 V/m from 27 to 500 MHz 1 kV coupled to AC lines 0.5 kV coupled to I/O lines	
Accuracy		<b>Tachometer Input</b>	
10 V range	±0.05 % of reading ±1.5 mV	Number of channels	
1 V range	±0.5 % of reading ±1.5 mV	1	
Stop-band	0.49 x sampling rate	Resolution	
SNR	typ. 106 dB	31 bits per channel	
THD (-0.5 dB) using 1 kHz sine wave @ 50 kS/s	typ. -90 dB	Input voltage range	
Spurious-free dynamic range (SFDR)	115 dB (f <sub>in</sub> = 1 kHz, -40 dB FS)	±30 V	
Max. input voltage without damage		Threshold voltage	
Power on	±30 V	±2 V with 0.5 V hysteresis	
Power off	±20 V	Max. input frequency	
Overvoltage protection	±40 V	380 kHz	
Input impedance	1 MOhm, 20 pF	Min. pulse width high / low	
ICP® excitation current	4 mA (±1 %)	1.3 µs	
ICP® compliance voltage	18 V	Measurement clock frequency	
AC coupling	0.5 Hz	12 MHz	
<b>Power Requirements</b>		<b>Bus Interface</b>	
Power supply	+5 V via USB	USB specification	
Current consumption from USB	500 mA, max.	USB 2.0 high speed	
		<b>Physical Characteristics</b>	
		Dimensions (typ.)	
		19x11x3 cm (7.5x4.3x1.2 in.)	
		Weight (typ.)	
		500 g (1.1 lb.)	
		<b>Environmental</b>	
		Operating temperature	
		0 to 50 °C	
		Storage temperature	
		-25 to 85 °C	
		Relative humidity	
		95%, non condensing	
		Altitude	
		up to 10,000 feet	

<sup>1</sup> Additional 0.5 % of reading if not using DEWEsoft 6.5 or newer

# DEWE-41-T-DSA

## Possible system configuration

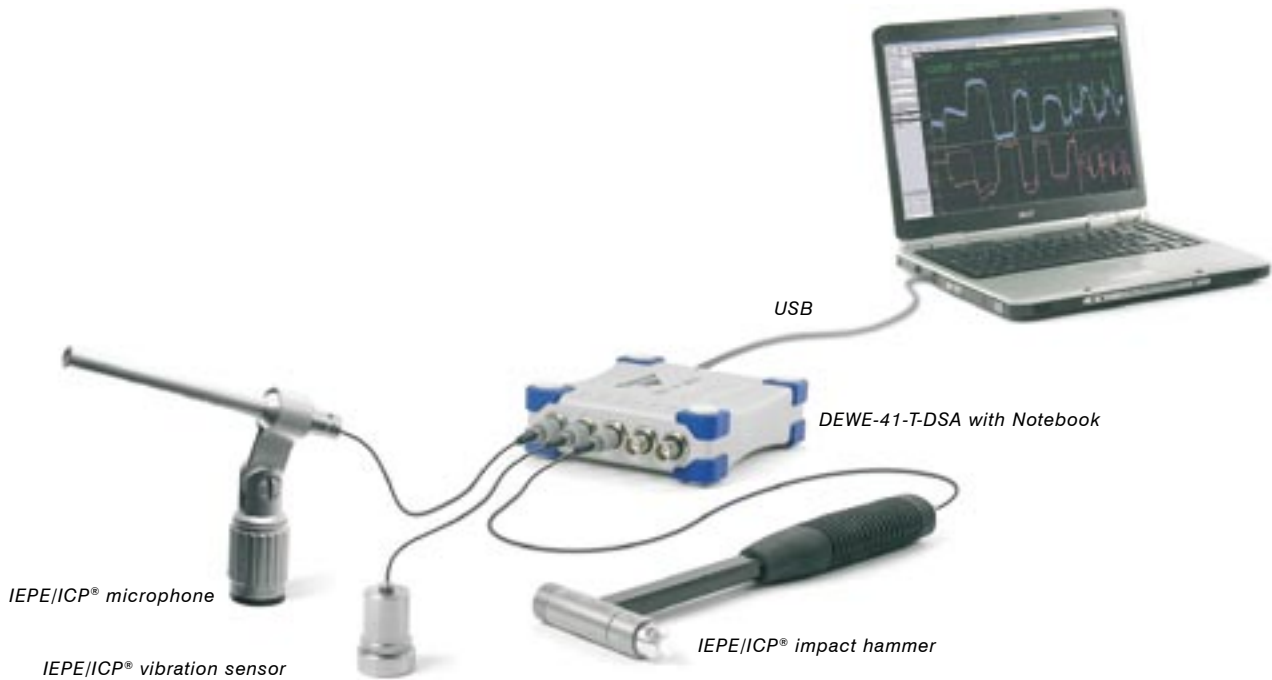

The DEWETRON handheld dynamic signal analyzer is a four-channel dynamic signal acquisition module for high-accuracy audio frequency measurements from IEPE/ICP® sensors. It delivers 115 dB of dynamic range and incorporates integrated electronic piezoelectric (IEPE/ICP®) signal conditioning for accelerometers and microphones. The four input channels simultaneously digitize input signals at rates from 0.19 to 52.7 kS/s.

## Connection

### Connector overview

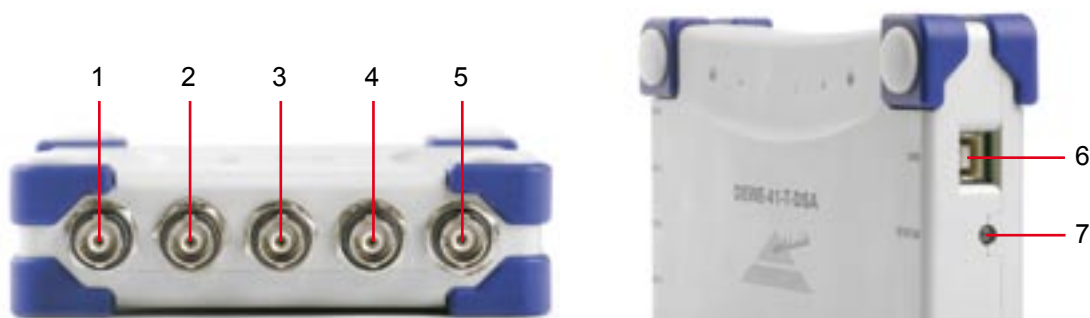

- 1.) A/D input channel 0
- 2.) A/D input channel 1
- 3.) A/D input channel 2
- 4.) A/D input channel 3
- 5.) Tachometer input channel

- 6.) USB interface connector
  - 7.) Status LED
- green: Device started  
red: Device measuring

Typical DEWE-41-T-DSA side view

ICP® is a trademark of PCB Piezotronics, Inc.

## A/D and Tachometer input channel connector

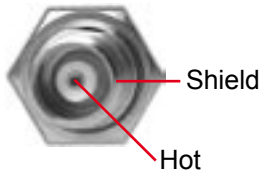

TNC connector

## High speed USB 2.0

The USB interface connectors meets standard USB pin assignment.



4 pin USB 2.0 connector



schematic

Pin assignment  
 1: +5 V  
 2: D-  
 3: D+  
 4: GND

## Tachometer input

In period time measurement the counter uses the internal time base to measure the period time of the signal present on counter source. The counter counts the rising edges of the internal time base which occurs between two rising edges on Counter Source. At the completion of the period interval the counter value is stored in a register and the counter starts counting from zero. At every sample clock (①, ②, ..., ⑥) the register value is read out.

The figure below shows a period time measurement.

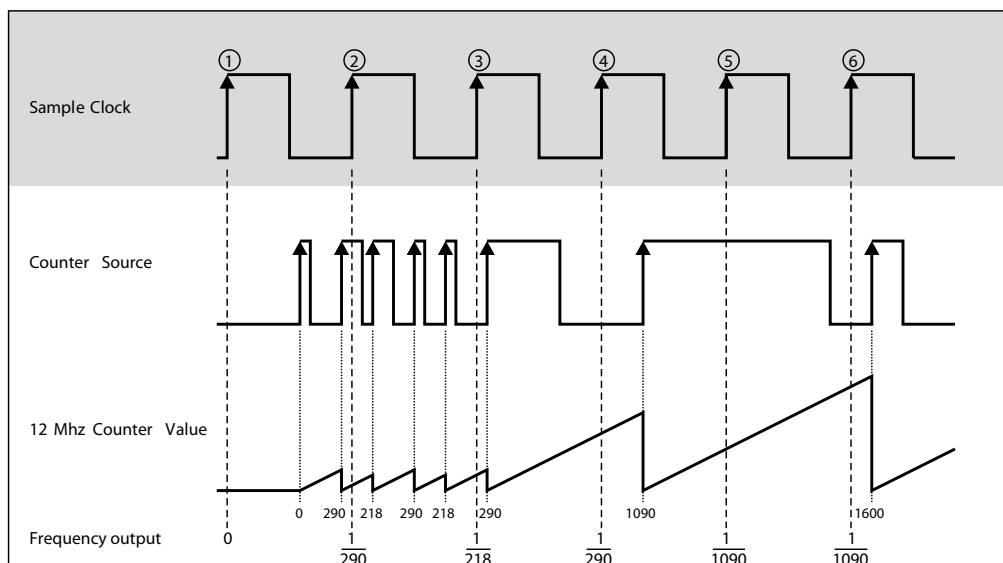

# DEWE-41-T-DSA

## Internal wiring of the DT9837 module

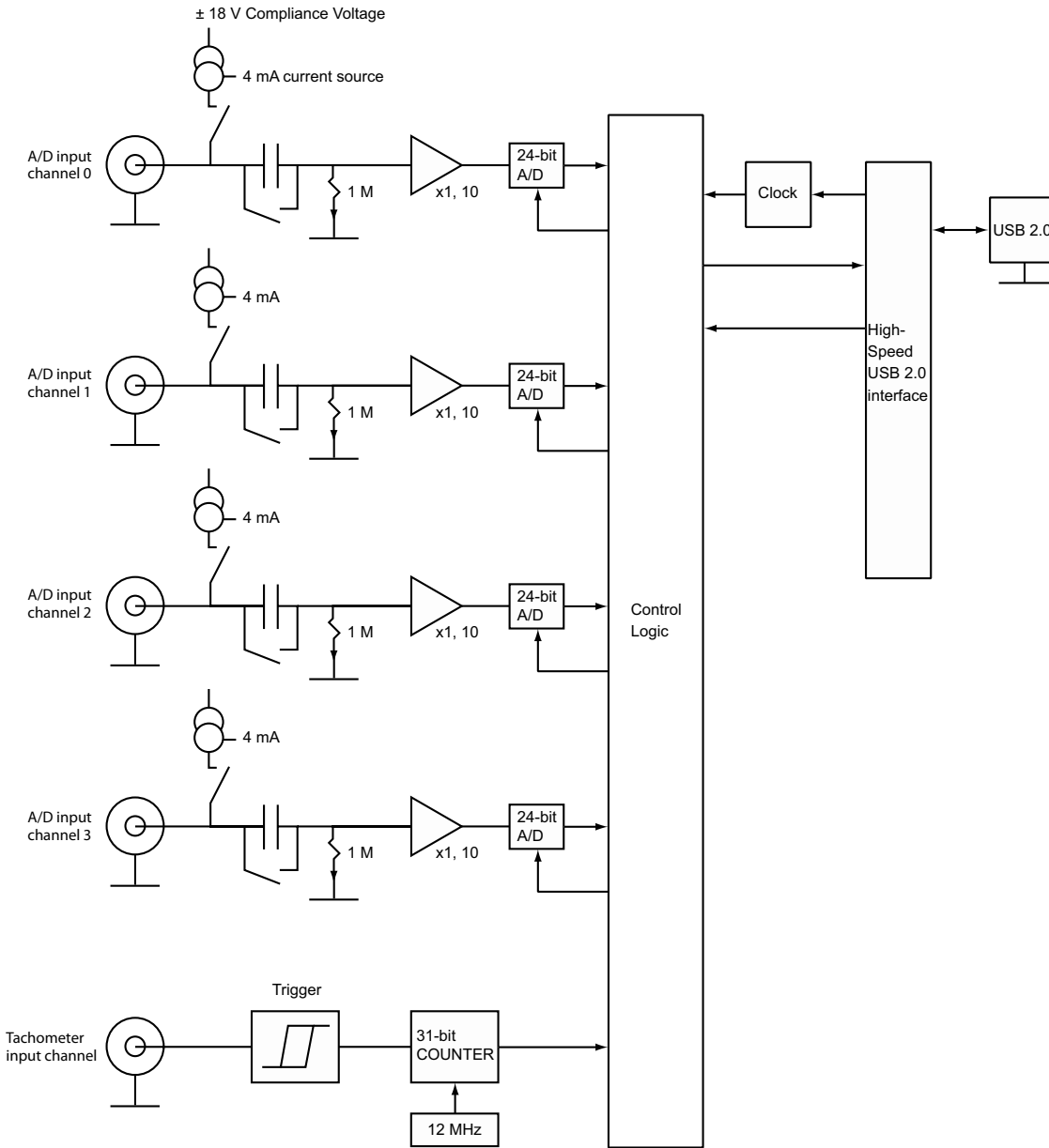

## Installation of DEWESoft 6.4

### DEWESoft System requirements

- WINDOWS 2000 / XP (Service pack 2 or service pack 4 for WIN2000)
- Intel Pentium 4 2.4 GHz processor or higher
- 512 MB RAM or higher
- Serial ATA or SCSI harddisks and/or RAID systems  
Approx. 120 MB free harddisk space for DEWESoft  
Additional 20 to 200 MB for drivers and post processing software packages
- A/D board for using real mode (requires licence key)

Start the installation software on the CD, shipped with the system.

Follow the instructions of the installation program according to your license.

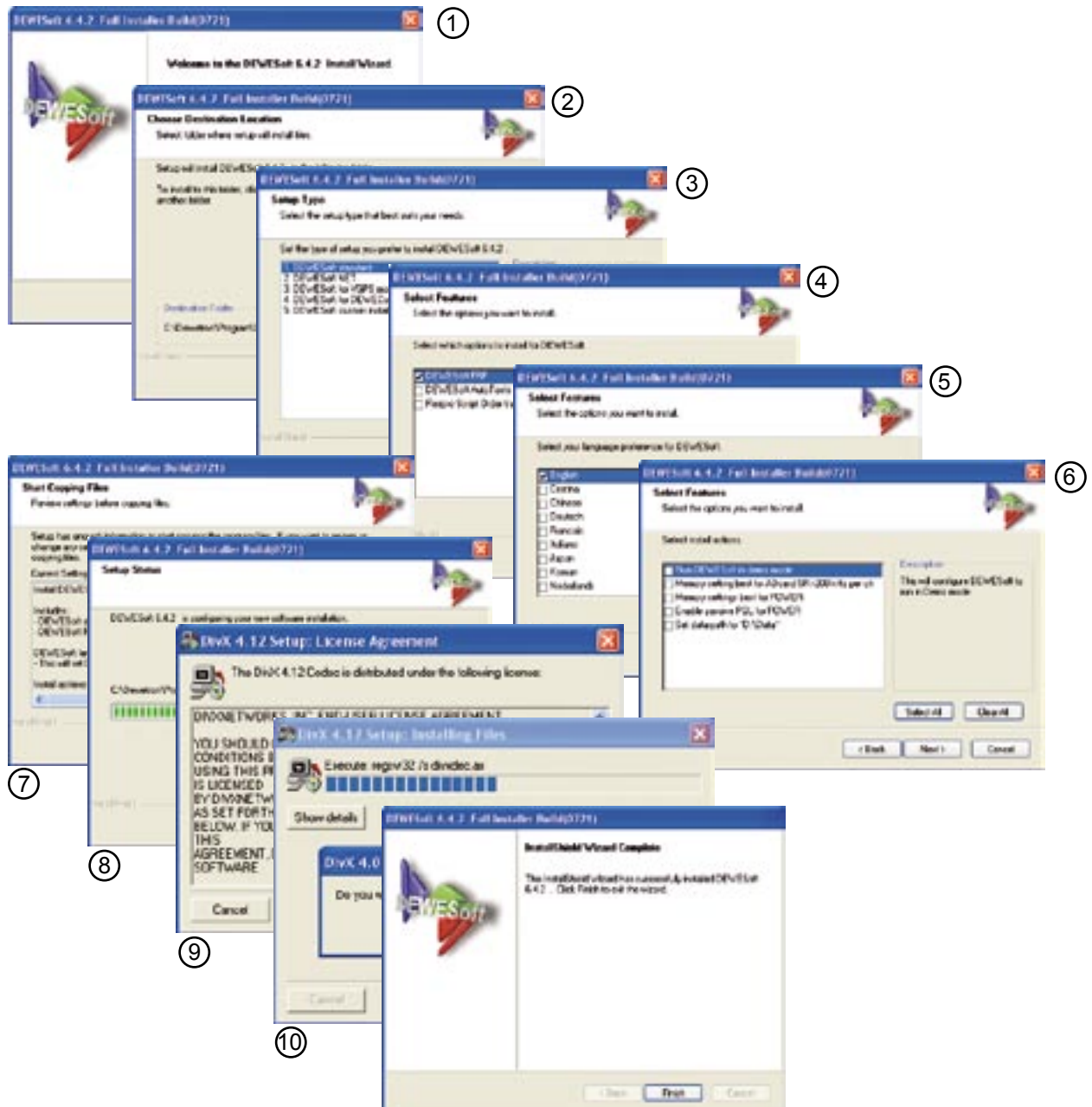

# DEWE-41-T-DSA

## Installation of the DEWE-41-T-DSA drivers

Execute the file „SetupOEMWin32.exe“ from the System-CD  
(usually D:\Install\Driver\DEWE-BOOK where D is the units CD-Drive letter).

*WARNING: Do not connect your DEWE-41-T-DSA BEFORE installing the drivers. Corresponding to your operation system you need to reinstall the found device and refer installing the T-DSA drivers.*

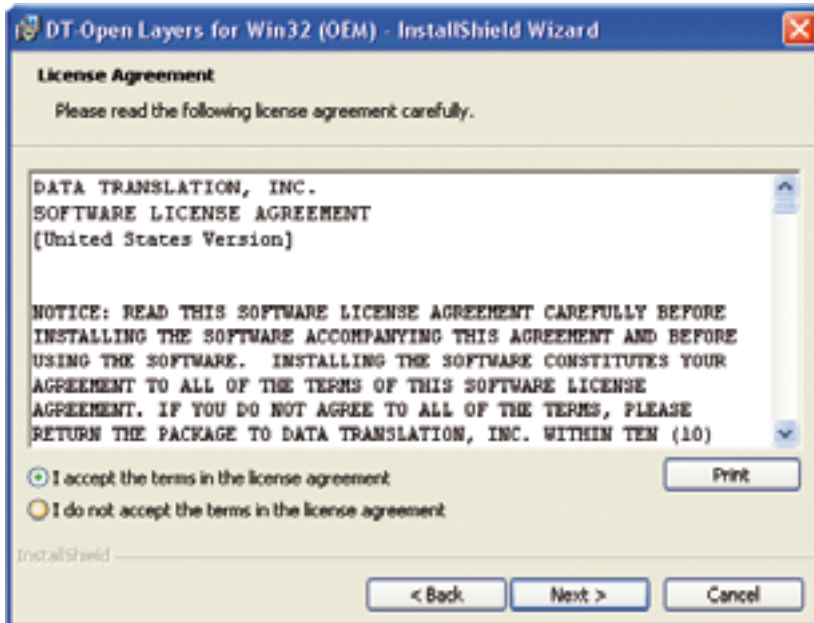

Step 1.) Accept the terms of the license agreement and press "Next".



Step 2.) Choose your destination folder and press "Next".



Now you should have successfully installed your DEWE-41-T-DSA (DT) driver.

After installing the drivers, connect your DEWE-41-T-DSA to your USB 2.0 device of your PC with the corresponding cable. It is also recommended to connect your DEWE-41-T-DSA always to the same USB 2.0 connector, otherwise you have to repeat the procedure of installing the drivers. Follow the instructions shown below.

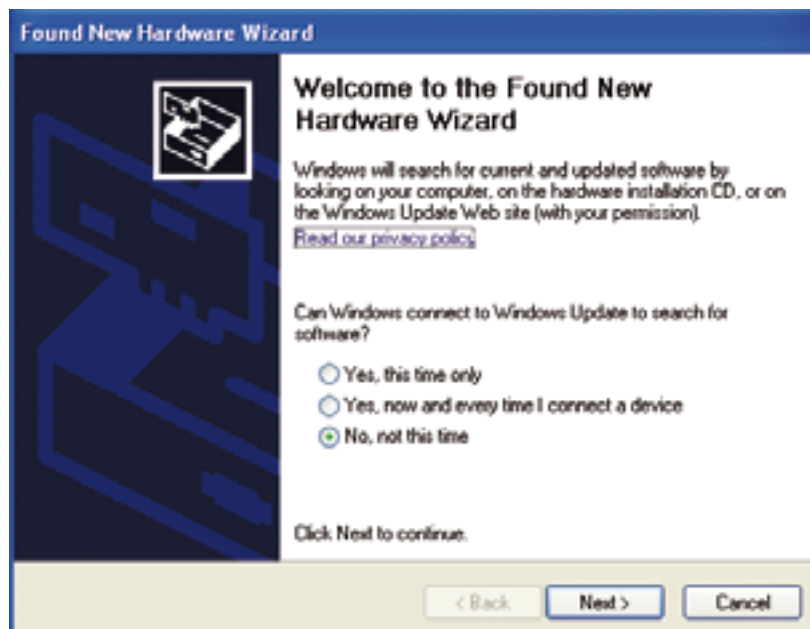

Step 3.) Choose "No, not this time" and press the "Next" button.

# DEWE-41-T-DSA

---

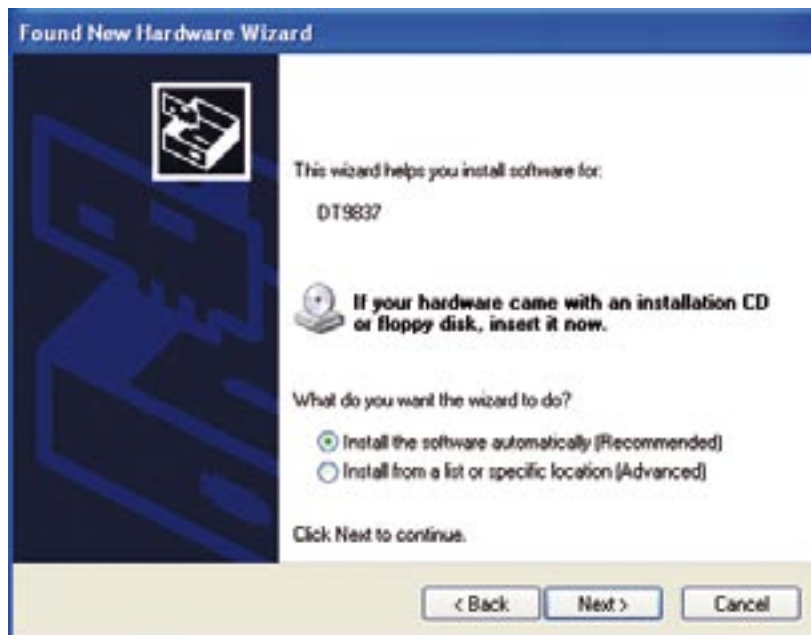

Step 4.) Choose "Install the software automatically (Recommended)" and proceed with "Next".



Now the drivers will be automatically installed.

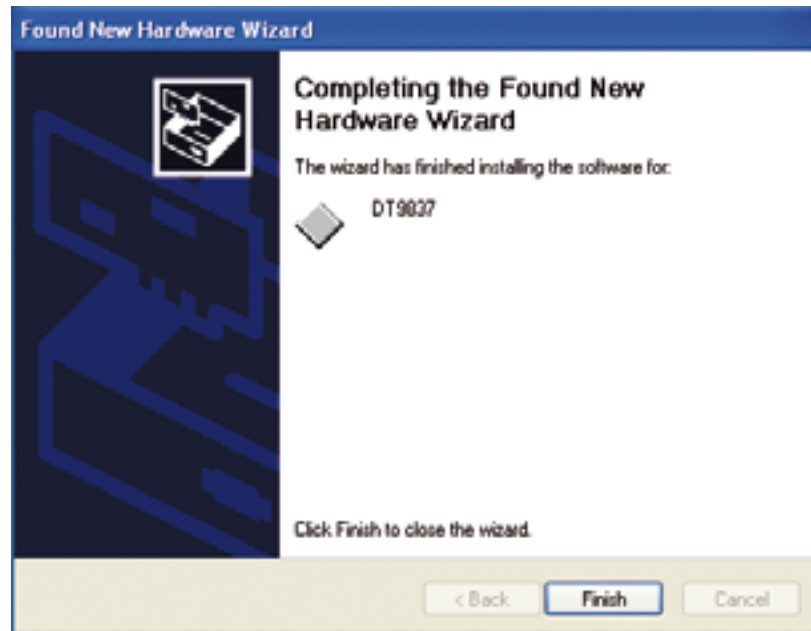

Step 5.) Press "Finish" and exit the installation of your system. Now you have successfully installed the DT9837 driver for your DEWE-41-T-DSA

## Hardware setup in DEWESoft

After proper installing your DEWE-41-T-DSA start DEWESoft and follow the instructions below.

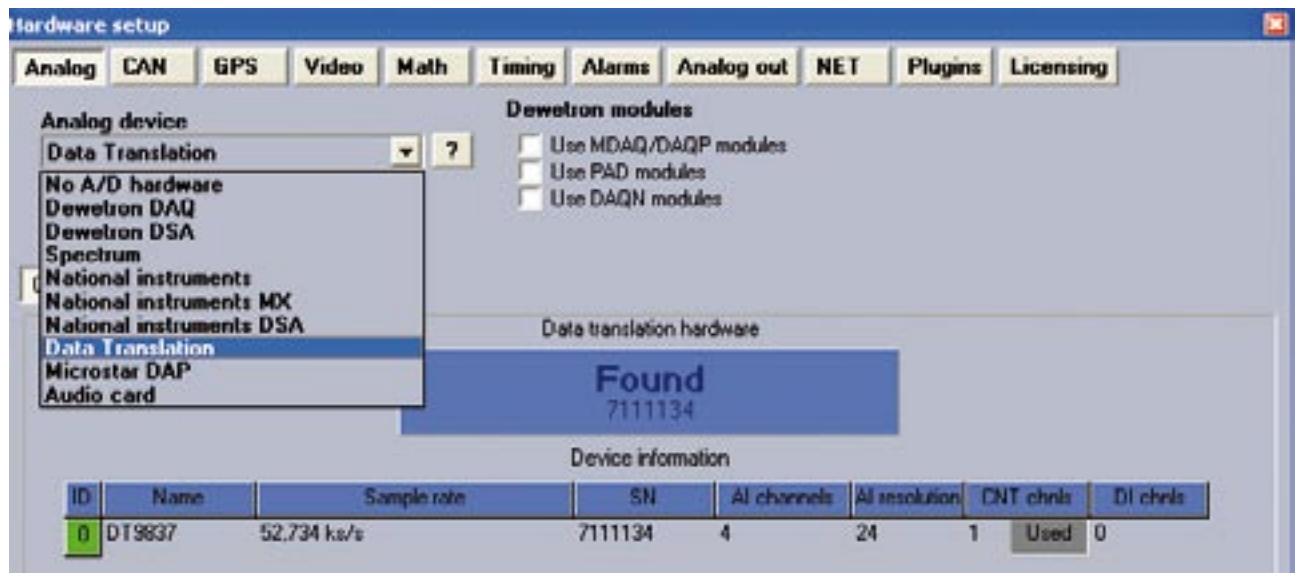

Run "Hardware setup" in DEWESoft and choose "Data translation" as your analog device. After this, DEWESoft should have found a hardware device called "Data translation hardware". Press the "CNT chnls" box to activate the Data Translation device.

# DEWE-41-T-DSA

Analog Counter CAN GPS Video Math Power Alarms Analog out									
<input type="checkbox"/> External clock		<input type="checkbox"/> Start on external trigger							
SLOT	ON/OFF	C	NAME	PHYSICAL VALUES		CAL	SETUP		
0	Used	AI 0	-10	10	Zero	Set ch. 0			
1	Used	AI 1	-10	10	Zero	Set ch. 1			
2	Used	AI 2	-10	10	Zero	Set ch. 2			
3	Used	AI 3	-10	10	Zero	Set ch. 3			

In the analog window, press the buttons to activate / deactivate the analog input channels.

Analog Counter CAN GPS Video Math Power Alarms Analog out									
SLOT	ON/OFF	C	NAME	VALUE		SETUP			
0	Used	CNT 0	0	Tacho	Setup				

Change to the "Counter" window if you want to activate the "Tachometer input". Press the "Setup" button to configure your analog inputs.

**Channel setup for channel 0**

**General** A/D opt. Sensors

Channel name: AI 0

Units: -

Color: [Green]

Min value: Automatic Max value: Automatic

Sample rate divider: 1 Skip

**Non-programmable modules**

Module type: No amplifier

Measure range: 10 to 10 V

In "General" you can define the "Channel name" and other options like "units" and "color".

# DEWE-41-T-DSA



Move to "A/D opt." and activate "AC coupling" and "ICP<sup>®</sup> input" if you want to use IEPE/ICP<sup>®</sup> sensors. You now should have successfully configured your DEWE-41-T-DSA in DEWESoft. For more information about DEWESoft please refer to the DEWESoft 6.4.2 Manual which is shipped with the software.