



Automotive
Energy & Power Analysis
Aerospace & Defense
Transportation
General Test & Measurement

DEWE-211

Technical reference manual



Test & Measurement Solutions



Copyright © DEWETRON elektronische Messgeraete Ges.m.b.H.

This document contains information which is protected by copyright. All rights are reserved. Reproduction, adaptation, or translation without prior written permission is prohibited, except as allowed under the copyright laws.

All trademarks and registered trademarks are acknowledged to be the property of their owners.
DEWESoft™ is a trademark of Dewesoft d.o.o

Thank you!

Thank you very much for your investment in DEWETRON's unique data acquisition systems. These are top-quality instruments which are designed to provide you years of reliable service. This guide has been prepared to help you get the most from your investment, starting from the day you take it out of the box, and extending for years into the future.

This guide includes important startup notes, as well as safety notes and information about keeping your DEWETRON system in good working condition over time.

We strongly suggest that you read this entire manual, especially the safety and care sections, as well as to avoid damaging your DEWETRON system.

What is the DEWE-211?

This product is used for measuring of different physical and/or electrical sizes (depending on model or configuration). The connection is depending on model or configuration and takes place via safety banana plugs, BNC connectors ($\pm 50V$ max.), D-SUB connectors ($\pm 50V$ max.), thermocouple connectors ($\pm 50V$ max.), BINDER® connectors ($\pm 50V$ max.), SMB connectors ($\pm 50V$ max.), μ dot connectors ($\pm 50V$ max.), LEMO® connectors or RJ-45 connectors.

Preface

Notes

Table of content

Content

General Information, Safety Instructions	7
Training	7
Calibration.....	7
Support	7
Service/repairs	7
Warranty Information	8
Printing History.....	8
Safety conventions	9
General safety and hazard warnings for all DEWETRON systems	10
Maintenance.....	13
Windows updates and antivirus/security software	14
Problematic network stacks	14
Environmental Considerations	14
First steps	
Blockdiagram of the internal signal processing	15
First steps	16
Main System	17
DEWE-211 - Standard instrument without display	17
System specifications	17
DEWE-211 at a glance	18
Possible configurations	23
MDAQ series amplifiers overview.....	24
Power supply	26
DIP-switch operation	27
Software	29
A/D Conversion	A1
Internal Wiring	B1
CE-Certificate of conformity	C1

Table of content

Training

DEWETRON offers training at various offices around the world several times each year. DEWETRON headquarters in Austria have a very large and professional conference and seminar center, where training classes are conducted on a regular basis starting with sensors and signal conditioning, A/D technology and software operation. For more information about training services, please visit:
<http://www.dewetron.com/support/training>

Dewetron Inc. in the USA also has a dedicated training facility connected to its headquarters, located in Rhode Island. For more information about training services in the US, please visit:
<http://www.dewamerica.com/support/trainingsclasses>

Calibration

Every instrument needs to be calibrated at regular intervals. The standard norm across nearly every industry is annual calibration. Before your DEWETRON data acquisition system is delivered, it is calibrated at our DEWETRON headquarter. Each of this system is delivered with a certificate of compliance with our published specifications. Detailed calibration reports from our calibration system are available for purchase with each order. We retain them for at least one year, so calibration reports can be purchased for up to one year after your system was delivered.

Support

DEWETRON has a team of people ready to assist you if you have any questions or any technical difficulties regarding the system. For any support please contact your local distributor first or DEWETRON directly.

For Asia and Europe, please contact:

DEWETRON Ges.m.b.H.
Parkring 4
A-8074 Graz-Grambach
AUSTRIA
Tel.: +43 316 3070
Fax: +43 316 307090
Email: support@dewetron.com
Web: <http://www.dewetron.com>

The telephone hotline is available
Monday to Friday between
08:00 and 17:00 CET (GMT +1:00)

Service/repairs

Only the team of DEWETRON is allowed to perform any kinds of repairs to your system to assure a safe and proper operation in future. For information regarding service and repairs please contact your local distributor first or DEWETRON directly.

For the Americas, please contact:

DEWETRON, Inc.
10 High Street, Suite K
Wakefield, RI 02879
U.S.A.
Tel.: +1 401 284 3750
Toll-free: +1 877 431 5166
Fax: +1 401 284 3755
Email: support@dewamerica.com
Web: <http://www.dewamerica.com>

The telephone hotline is available
Monday to Friday between
08:00 and 17:00 GST (GMT -5:00)



Any spare parts (screws, backplanes, cables,...) must be obtained from DEWETRON only.

Notice

The information contained in this document is subject to change without notice.

DEWETRON elektronische Messgeraete Ges.m.b.H. (DEWETRON) shall not be liable for any errors contained in this document. DEWETRON MAKES NO WARRANTIES OF ANY KIND WITH REGARD TO THIS DOCUMENT, WHETHER EXPRESS OR IMPLIED. DEWETRON SPECIFICALLY DISCLAIMS THE IMPLIED WARRANTIES OF MERCHANTABILITY AND FITNESS FOR A PARTICULAR PURPOSE. DEWETRON shall not be liable for any direct, indirect, special, incidental, or consequential damages, whether based on contract, tort, or any other legal theory, in connection with the furnishing of this document or the use of the information in this document.

Warranty Information

A copy of the specific warranty terms applicable to your DEWETRON product and replacement parts can be obtained from your local sales and service office.

Restricted Rights Legend

Use austrian law for duplication or disclosure.

DEWETRON GesmbH
Parkring 4
A-8074 Graz-Grambach / Austria

TRION™ is a trademark of DEWETRON Ges.m.b.H.

SYNC-CLOCK™ is a trademark of DEWETRON Ges.m.b.H.

SUPER-COUNTER™ is a trademark of DEWETRON Ges.m.b.H.

DEWESoft™ is a trademark of DEWESoft d.o.o.

Any other trademarks and registered trademarks are acknowledged to be the property of their owners.

Printing History

Please refer to the page bottom for printing version.

Copyright © DEWETRON elektronische Messgeraete Ges.m.b.H.

This document contains information which is protected by copyright. All rights are reserved. Reproduction, adaptation, or translation without prior written permission is prohibited, except as allowed under the copyright laws.

Safety conventions

Safety conventions



Observe precautions for handling electrostatic sensitive devices!



This icon denotes a caution, which advises you of precautions to take to avoid injury, data loss, or a system crash. When this symbol is marked on the product, refer to the technical reference manual.



Indicates hazardous voltages.



Indicates the chassis terminal

WARNING *Calls attention to a procedure, practice, or condition that could cause bodily injury or death.*

CAUTION *Calls attention to a procedure, practice, or condition that could possibly cause damage to equipment or permanent loss of data.*

Safety instructions

Your safety is our primary concern! Please be safe!



General safety and hazard warnings for all DEWETRON systems

- Use this system under the terms of the specifications only to avoid any possible danger. If the unit is used in a manner not specified by the manufacturer the protection can be impaired!
- This product is intended for use in industrial locations. As a result, this product may cause interference if used in residential areas. Such use must be avoided unless the user takes special measures to reduce electromagnetic emissions to prevent interferences to the reception of radio and television broadcasts.
- Maintenance will be executed by qualified staff only.
- During the use of the system, it might be possible to access another parts of a more comprehensive system. Please read and follow the safety instructions provided in the manuals of all other components regarding warning and security advices for using the system.
- With this product, only use the power cable delivered or defined for the host country.
- DO NOT connect or disconnect sensors, probes or test leads, as these parts are connected to a voltage supply unit.
- The system is grounded via a protective conductor in the power supply cord. To avoid electric shocks, the protective conductor has to be connected with the ground of the power network. Before connecting the input or output connectors of the system, make sure that there is a proper grounding to guarantee potential free usage. For countries, in which there is no proper grounding, please refer to your local legally safety regulations for safety use.

DC systems: Every DC system has a grounding connected to the chassis (yellow/green safety banana plug).

- Please note the characteristics and indicators on the system to avoid fire or electric shocks. Before connecting the system, please carefully read the corresponding specifications in the product manual.
- The inputs are not, unless otherwise noted (CATx identification), for connecting to the main circuits of category II, III and IV. The measurement category can be adjusted depending on module configuration.
- The power cord separates the system from the power supply. Do not block the power cord, since it has to be accessible for the users.
- Supply overvoltage category is II.
- DO NOT use the system if equipment covers or shields are removed.
- If you assume the system is damaged, get it examined by authorised personnel only.
- Any use in wet rooms, outdoors or in adverse environmental condition is not allowed!
Adverse environmental conditions are:
 - Moisture or high humidity
 - Dust, flammable gases, fumes or dissolver
 - Thunderstorm or thunderstorm conditions (except assembly PNA)
 - Electrostatic fields, et cetera.
- Any direct voltage output is protected with a fuse against short cut and reverse-polarity, but is NOT galvanically isolated (except it is explicit marked on the system).
- The system must be connected and operated to an earthed wall socket at the AC mains power supply only (except for DC systems).
- Any other use than described above may damage your system and is attended with dangers like shortcut, fire or electric shocks.

Safety instructions

- The whole system must not be changed, rebuilt or opened (except for changing TRION™ modules).
 - If you assume a more riskless use is not provided anymore, the system has to be rendered inoperative and should be protected against inadvertent operation. It is assumed that a more riskless operation is not possible anymore, if
 - the system is damaged obviously or causes strange noises.
 - the system does not work anymore.
 - the system has been exposed to long storage in adverse environmental.
 - the system has been exposed to heavy shipment strain.
 - DO NOT touch any exposed connectors or components if they are live wired. The use of metal bare wires is not allowed. There is a risk of short cut and fire hazard!
 - Warranty void if damages caused by disregarding this manual. For consequential damages NO liability will be assumed!
 - Warranty void if damages to property or persons caused by improper use or disregarding the safety instructions.
 - Unauthorized changing or rebuilding the system is prohibited due to safety and permission reasons (CE). Exception: changing TRION™ modules.
 - The assembly of the system is equivalent to protection class I. For power supply, only the correct power socket of the public power supply must be used, except the system is DC powered.
 - Be careful with voltages $>25 V_{AC}$ or $>35 V_{DC}$! These voltages are already high enough in order to get a perilous electric shock by touching the wiring.
 - Maximum input voltage for measuring cards are $70 V_{DC}$ and $46.7 V_{PEAK}$
 - The product heats during operation. Make sure there is adequate ventilation. Ventilation slots must not covered!
 - Only fuses of the specified type and nominal current may be used. The use of patched fuses is prohibited.
 - Prevent using metal bare wires! Risk of short cut and fire hazard!
 - DO NOT use the system before, during or shortly after a thunderstorm (risk of lightning and high energy overvoltage). An advanced range of application under certain conditions is allowed with therefore designed products only. For details please refer to the specifications.
 - Make sure that your hands, shoes, clothes, the floor, the system or measuring leads, integrated curcuits and so on, are dry.
 - DO NOT use the system in rooms with flammable gases, fumes or dust or in adverse environmental conditions.
 - Avoid operation in the immediate vicinity of:
 - high magnetic or electromagnetic fields
 - transmitting antennas or high-frequency generators
- For exact values please refere to enclosed specifications.
- Use measurement leads or measurement accessories aligned to the specification of the system only. Fire hazard in case of overload!
 - Do not switch on the system after transporting it from a cold into a warm room and vice versa. The thereby created condensation may damage your system. Acclimatise the system unpowered to room temperature.
 - Do not disassemble the system! There is a high risk of getting a perilous electric shock. Capacitors still might charged, even the system has been removed from the power supply.

Safety instructions

- The electrical installations and equipments in industrial facilities must be observed by the security regulations and insurance institutions.
- The use of the measuring system in schools and other training facilities must be observed by skilled personnel.
- The measuring systems are not designed for use at humans and animals.
- Please contact a professional if you have doubts about the method of operation, safety or the connection of the system.
- Please be careful with the product. Shocks, hits and dropping it from already lower level may damage your system. For exact values please refer to enclosed specifications.
- Please also consider the detailed technical reference manual as well as the security advices of the connected systems.

This product has left the factory in safety-related flawless and proper condition.

In order to maintain this condition and guarantee safety use, the user has to consider the security advices and warnings in this manual.

EN 61326-3-1:2008

IEC 61326-1 applies to this part of IEC 61326 but is limited to systems and equipment for industrial applications intended to perform safety functions as defined in IEC 61508 with SIL 1-3.

The electromagnetic environments encompassed by this product family standard are industrial, both indoor and outdoor, as described for industrial locations in IEC 61000-6-2 or defined in 3.7 of IEC 61326-1. Equipment and systems intended for use in other electromagnetic environments, for example, in the process industry or in environments with potentially explosive atmospheres, are excluded from the scope of this product family standard, IEC 61326-3-1.

Devices and systems according to IEC 61508 or IEC 61511 which are considered as “operationally well-tried”, are excluded from the scope of IEC 61326-3-1.

Fire-alarm and safety-alarm systems, intended for protection of buildings, are excluded from the scope of IEC 61326-3-1.



*For safety reasons max. 50 V may be applied to the BNC input-connectors!
Refer to the regulation of maximum allowable touch potential.*

Maintenance

The information in this section is designed for use by qualified service personal.

Service interval:

Clean dust from the chassis exterior/interior and exchange filter foam based on the operating environment.

Cleaning:

Clean surface of the chassis with dry lint-free cloth.

Use a dry velocity stream of air to clean the chassis interior.



- Disconnect all cables before servicing the unit!
- Many components within the chassis are sensitive to static discharge damage. Always wear a ground wrist strap and service the unit only in static-free environment.
- Do not use harsh chemical cleaning agents!

General information

CAUTION

- The system BIOS is protected by password. Any change in the BIOS may cause a system crash. When the system is booting, do not press ESC-button on keyboard. This may clear the BIOS settings and cause system faults.
- Any change in the file structure as deleting or adding files or directories might cause a system crash.
- Before installing software updates contact DEWETRON or your local distributor. Use only software packages which are released by DEWETRON. Further informations are also available in the internet (<http://www.dewetron.com>).
- After power off the system wait at least 10 seconds before switching the system on again. Otherwise the system may not boot correct. This prolongs also the life of all system components.

Windows updates and antivirus/security software

Before installing Windows software updates consult with DEWETRON for compatibility guidance. Please also keep in mind that the use of any antivirus or other security software may slow down your system and may cause data loss.

Problematic network stacks

Often intrusive IT software or network processes can interfere with the primary function of the DEWETRON system: to record data. Therefore we recommend strongly against the installation of IT/MIS software and running their processes on any DEWETRON data acquisition system, and cannot guarantee the performance of our systems if they are so configured.



Environmental Considerations

Information about the environmental impact of the product.

Product End-of-Life Handling

Observe the following guidelines when recycling a DEWETRON system:

System and Components Recycling

Production of these components required the extraction and use of natural resources. The substances contained in the system could be harmful to your health and to the environment if the system is improperly handled at it's end of life! Please recycle this product in an appropriate way to avoid an unnecessary pollution of the environment and to keep natural resources.

This symbol indicates that this system complies with the European Union's requirements according to Directive 2002/96/EC on waste electrical and electronic equipment (WEEE). Please find further information about recycling on the DEWETRON website www.dewetron.com

Restriction of Hazardous Substances

This product has been classified as Monitoring and Control equipment, and is outside the scope of the 2011/65/EU RoHS Directive. This product is known to contain lead.

Blockdiagram of the internal signal processing

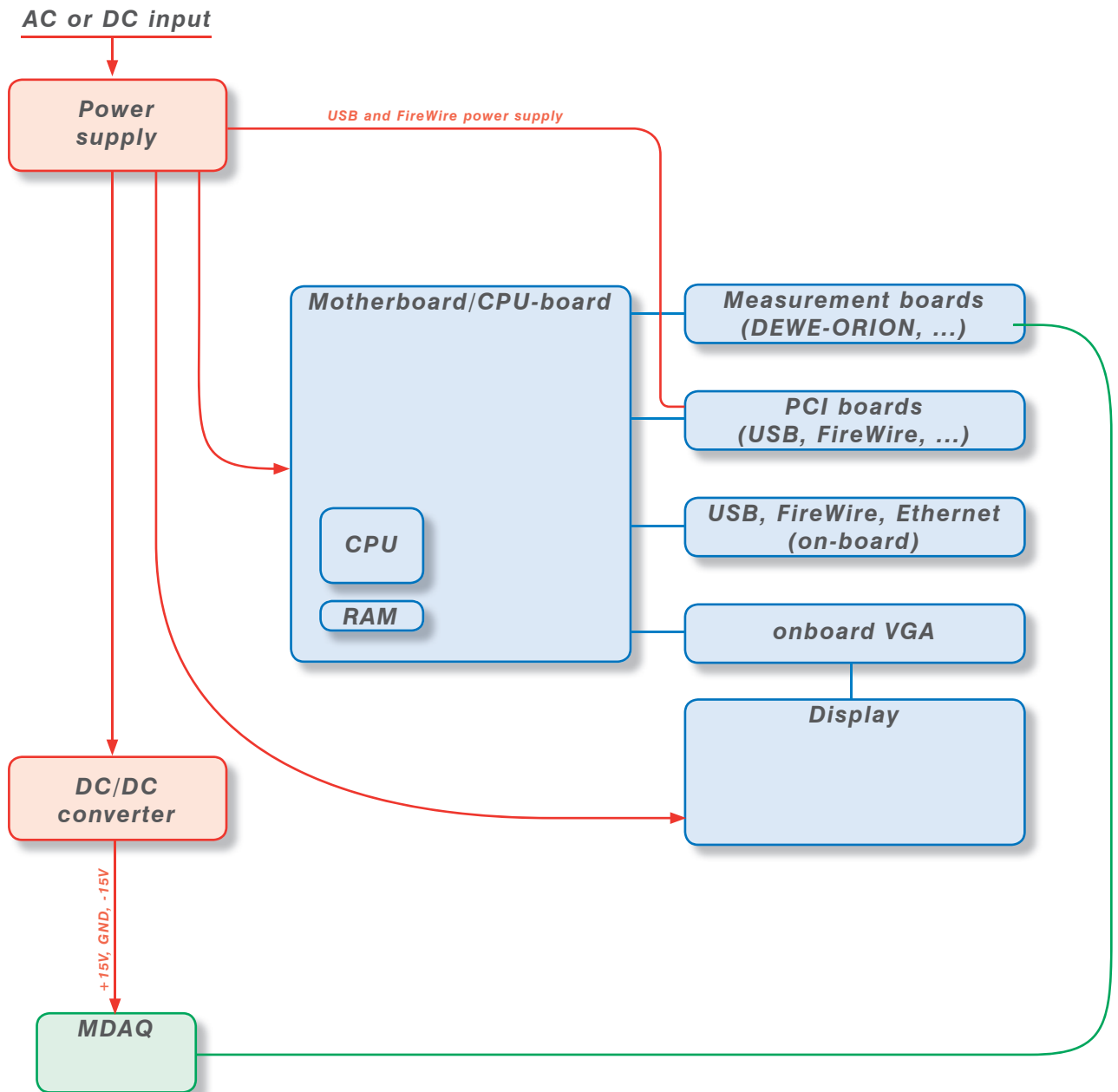

First steps

First steps

1



Power-on your system.

2

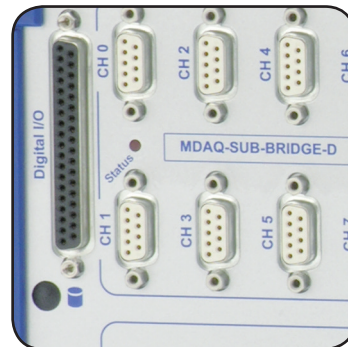

Connect your sensors to the system.

3

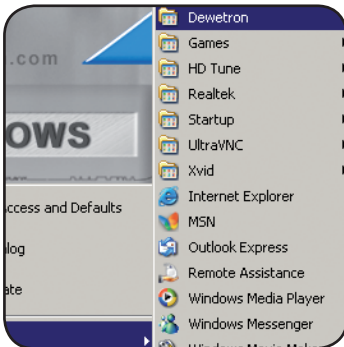

Run DEWESoft usually via "Start" >"Programs" > "Dewetron" > "DEWESoft x.x" > "DEWESoft x.x"

4

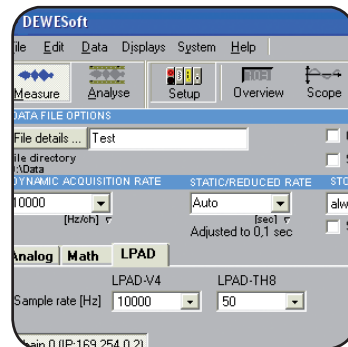

Start recording your data!

All accessories shown in this document are available as option and will not be shipped as standard parts. These parts are described as "option".

DEWE-211 - Standard instrument without display

- Rugged small-size standalone instrument
- 16 MDAQ input channels (voltage, IEPE®, bridge or strain)
- 2 counter input (encoder), CAN-bus
- EPAD interface for adding quasi-static thermo couple or voltage channels
- Local data storage or online data transfer via Ethernet
- A/D converter specs see appendix A



System specifications

DEWE-211	
Channel 0 to 7 Channel 8 to 15	<input checked="" type="checkbox"/> MDAQ-DIRECT <input checked="" type="checkbox"/> MDAQ-V-10 <input checked="" type="checkbox"/> MDAQ-V-100 <input checked="" type="checkbox"/> MDAQ-SUB-V-200 <input checked="" type="checkbox"/> MDAQ-SUB-ACC-x <input checked="" type="checkbox"/> MDAQ-SUB-ACC-A-x <input checked="" type="checkbox"/> MDAQ-SUB-BRIDGE <input checked="" type="checkbox"/> MDAQ-SUB-STG <input checked="" type="checkbox"/> MDAQ-BASE-5 <input checked="" type="checkbox"/> MDAQ-BASE-10 <input checked="" type="checkbox"/> MDAQ-FILT-5-BU <input checked="" type="checkbox"/> MDAQ-FILT-5-BE <input checked="" type="checkbox"/> MDAQ-FILT-5-BU-S1 <input checked="" type="checkbox"/> MDAQ-FILT-10 <input checked="" type="checkbox"/> MDAQ-FILT-10-S1 <input checked="" type="checkbox"/> MDAQ-AAF4-5-BU
Power supply: Rated input voltage:	7 to 27 V _{DC} (max. 6 to 30 V _{DC}) ATX power supply (> 10 V _{DC} are required if external accessories are connected)*; external AC power supply included; 250 W
Operating temperature:	0 °C to +50 °C
Storage temperature:	-20 °C to +70 °C
Humidity (operating):	10 % to 80 %, non condensing 5 % to 95 % rel. humidity
Vibration test**: EN 60068-2-6	Shape Sine Frequency range 10 - 150 Hz Acceleration 2 g Sweep rate 1 oct./min. Duration 20 Cycles Test in 3 directions
Vibration test**: EN 60721-3-2 Class 2M2	Shape Random Frequency range 10 - 200 Hz Power spectral density 1 m/s ² / Hz from 10 – 200 Hz Duration 30 Minutes per axis
Shocktests**: EN 60068-2-27	Shape Half-sine Acceleration amplitude 15 g Duration 11 ms Test in 3 axis, 3 shocks in each axis and direction
Dimensions (W x H x D):	approx. 285 x 230 x 88 mm (11.2 x 3.5 x 0.9 in.)
Weight:	typ. 4 kg (8.8 lbs), depending on configuration
*) Further information see chapter 'DIP-switch operation'.	
**) Tested with SSD disc	

Main System

Dimensions*

* Dimensions in mm
(1 inch = 25.4 mm)

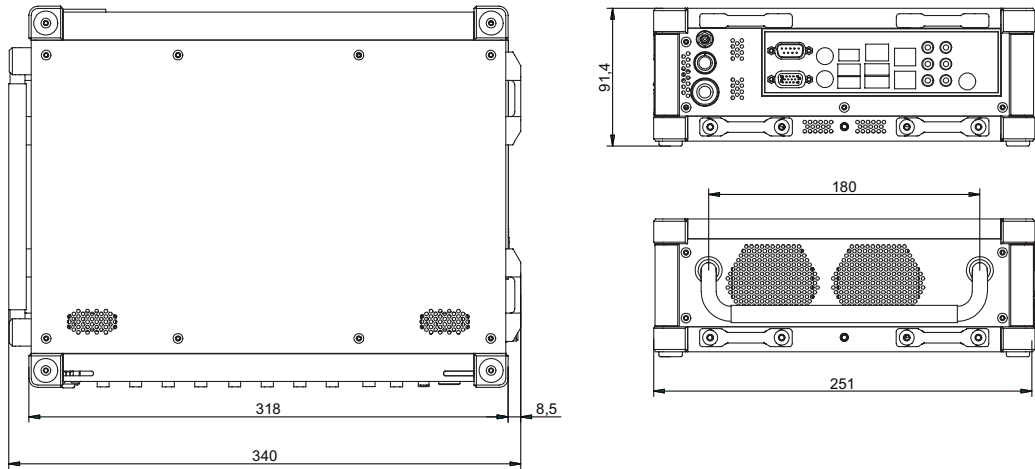

DEWE-211 at a glance

Connector overview:

- | | | |
|---|--|---------------------------|
| 1 Power-on button | 8 WLAN antenna | 15 IEEE-1394 (FireWire®) |
| 2 Chassis terminal | 9 Power supply for accessories (12 V _{DC}) Lemo FGG.1B.302 | 16 Ethernet LAN connector |
| 3 Digital I/O connector | 10 Power supply input (EGJ.2B.303.CLA) | 17 Audio device interface |
| 4 CAN interface | 11 RS232 interface connector | 18 MDAQ interface |
| 5 Counter inputs | 12 VGA connector | |
| 6 Optional Expansion interface connector (Expansion E0) | 13 PS/2 mouse & keyboard connector | |
| 7 EPAD connector | 14 USB interface connectors | |

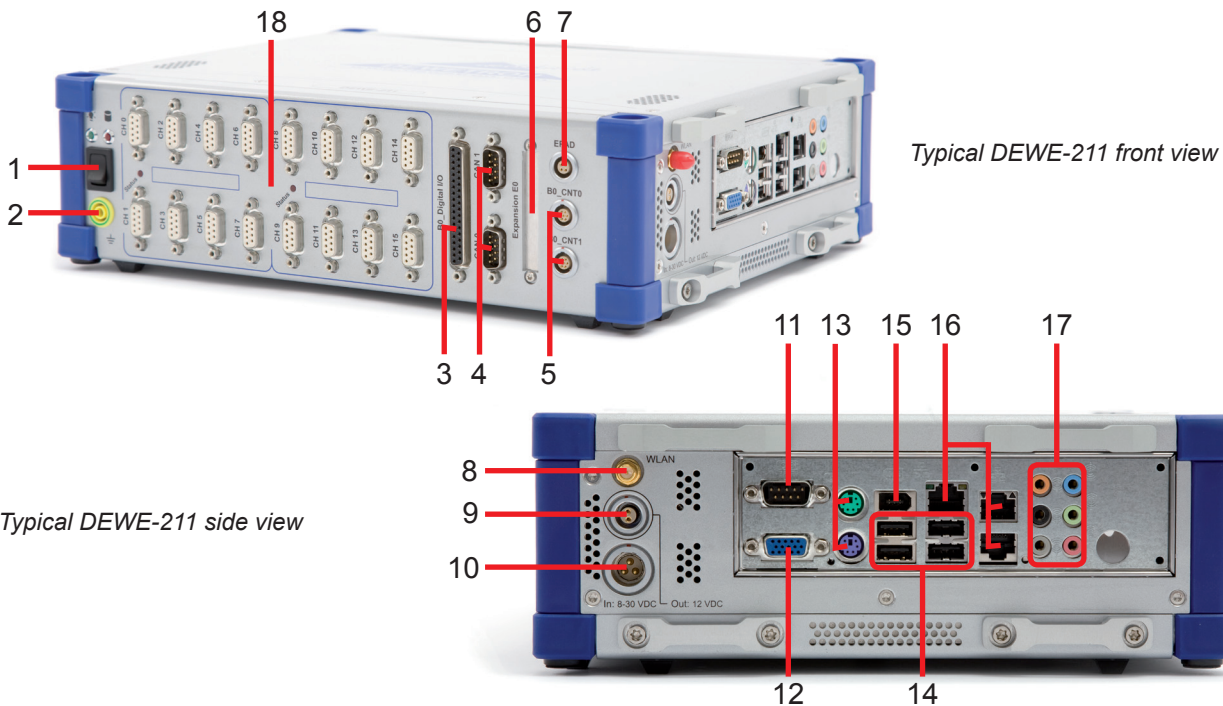

Note: The location of the connectors might vary from system to system and depends on system configuration

1 Power-on switch

The power-on switch has to be used to switch on the system.

2 Chassis terminal

For some kind of measurements, it's necessary to give the system an additional ground connection.

3 Digital I/O connector

This connector supports digital input and output lines of the built-in DEWE-ORION series board. If this board does not support digital I/O's, the connector is not available.

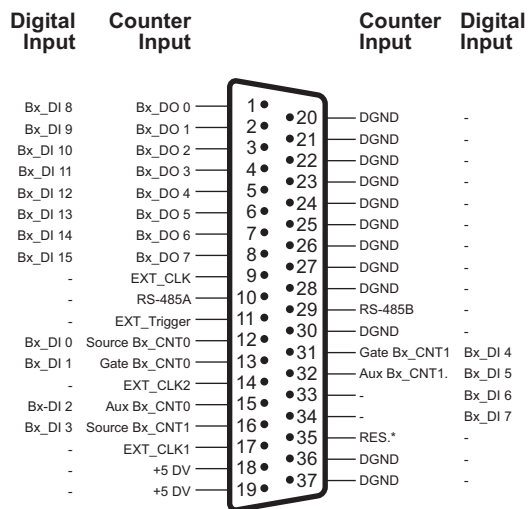

Note: Only available for standard systems using ORION-xxxx cards!

37-pin SUB-D connector

4 CAN connector

This connector supports the CAN signals of the built-in A/D board. If this board does not support CAN signals, the connector is not available.

CAN 0:

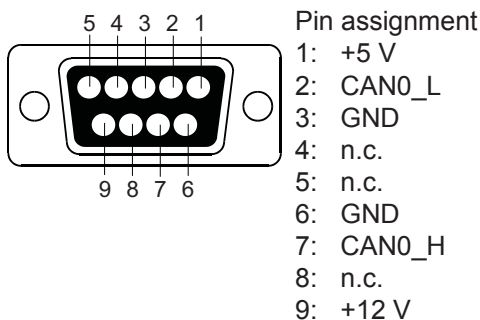

CAN 1:

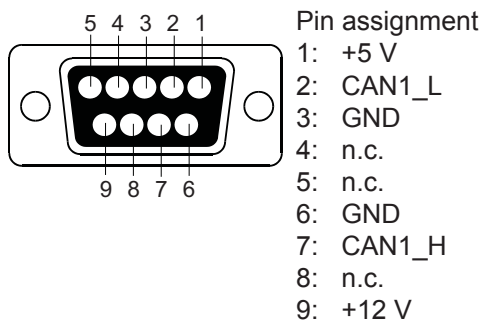

Main System

5 Counter inputs (in conjunction with DEWE-ORION-xxxx boards)

- 1: Source Bx_CNT(n)
- 2: Aux_Bx_CNT(n)
- 3: Gate Bx_CNT(n)
- 4: Power GND
- 5: +5 V (max. 500 mA)
- 6: +12 V (max. 500 mA)
- 7: Signal GND
- n .. channels 0 to 1 of counter board

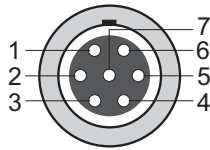

7-pin female LEMO connector
EGG.1B.307

Mating connector:
LEMO FGG.1B.307.CLAD52Z
(for cable diameter 4.1 to 5.0 mm)
LEMO FGG.1B.307.CLAD62Z
(for cable diameter 5.1 to 6.0 mm)
Cable to open end, 5 m long:
CTR-CBL-05

6 Optional Expansion interface connector (in conjunction with DEWE-ORION-xxxx boards)

The ORION expansion interface connector is installed in case the system is equipped with a 32 channel ORION card or a ORION card with counter expansion.

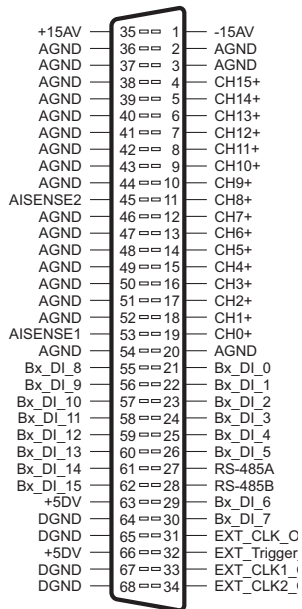

ORION card with 32 analog inputs
(ORION-3216-10x, ORION-3222-10x)

68-pin Amplimite series
(AMP: 174339-5) SCSI II

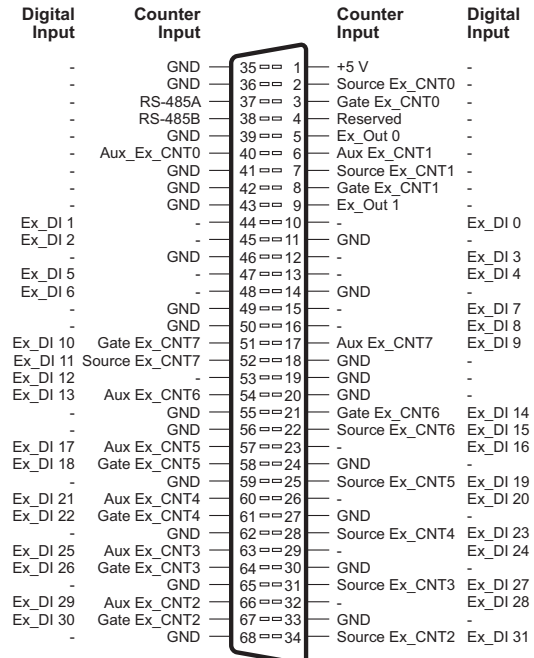

ORION card with counter expansion
(ORION-xxxx-x02, -x03, -x04, -x05)

68-pin Amplimite series
(AMP: 174339-5) SCSI II



Note: Only available for standard systems using ORION-xxxx cards!

7 EPAD connector

To connect DEWETRON EPAD modules to the system.

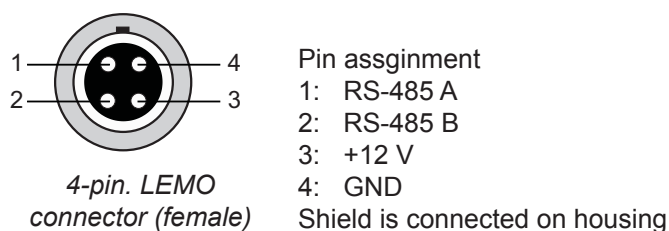

Mating connector: LEMO FGG.1B.304.CLAD52Z (for cable diameter 4.1 to 5.0 mm)
LEMO FGG.1B.304.CLAD62Z (for cable diameter 5.1 to 6.0 mm)

8 WLAN antenna

The DEWE-1201 supports 802.11 b/g/n WLAN standards.

9 Power supply for accessories

To supply your accessories with 12 V_{DC}. Fused with an 1.5 A self-recovering fuse.



Lemo EGG.1B.302

Mating connector: LEMO FGG.1B.302.CLAD52Z (for cable diameter 4.1 to 5.0 mm)
LEMO FGG.1B.302.CLAD62Z (for cable diameter 5.1 to 6.0 mm)

10 Power supply input connector

For details see chapter power supply.

11 RS-232 interface connector

The RS-232 interface connector meets standard RS-232 pin assignment.

12 VGA connector

The VGA connector offers the possibility to connect a CRT or other standard VGA displays to the system. Some systems have a DVI connector instead or additionally to the VGA.

Note: After the start up of the system there are only analog signals available and do not operate with a DVI-DVI cable. The monitor has to be connected to the standard VGA connector with the provided DVI adapter or an DVI-VGA cable (not included).

13 PS/2 mouse / keyboard connector

The mouse / keyboard connector could be used to connect a keyboard or an external PS/2 mouse. The connector meets standard PS/2 pin assignment.

14 USB interface connectors (Universal Serial Bus)

The USB interface connectors meets standard USB pin assignment.

Main System

15 IEEE-1394 (FireWire®) connector

The IEEE-1394 interface connectors meets standard Firewire® pin assignment.

16 Ethernet connector

The DEWE-201 system supports 10/100/1000 BaseT Ethernet with standard RJ45 connector.

18 MDAQ panel

For details see chapter 'MDAQ series amplifiers overview'.



*For safety reasons max. 50 V may be applied to the BNC input-connectors!
Refer to the regulation of maximum allowable touch potential.*

Possible configurations

Typical system configurations



16 channels MDAQ (DSUB)



16 channels MDAQ (8 DSUB, 8 BNC)



16 channels MDAQ (BNC)

32 channel configuration; using DEWE-ORION-3216-10x or -3222-10x cards

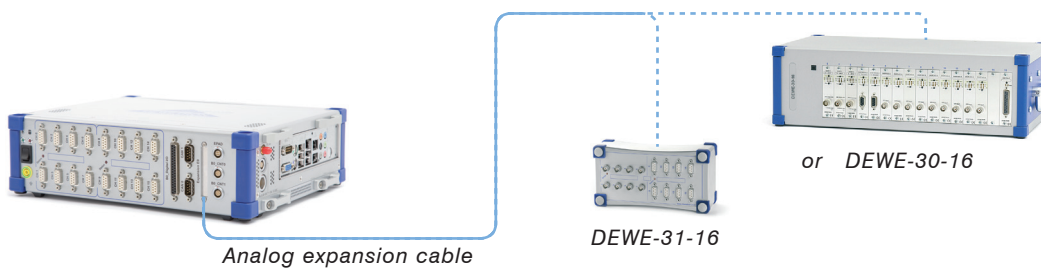

Cascading systems using DEWESoft NET



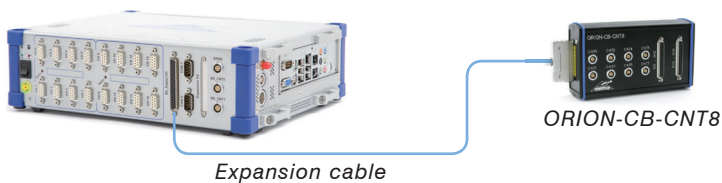

Up to 10 counters; using DEWE-ORION cards with 10 counters (DEWE-ORION-1616-105, -1622-104, -1624-102 etc.)

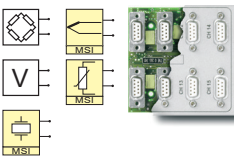
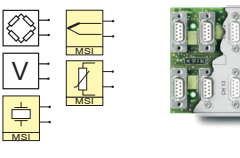
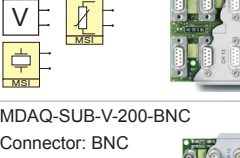
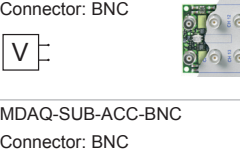
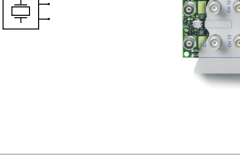

Main System

MDAQ series amplifiers overview

SUB Modules for MDAQ-BASE-x						
Module	# CH	Input type	Ranges	TEDS	Bandwidth (BW), Highpass filters (HP)	Excitation
MDAQ-SUB-STG-D Connector: DB-9 	8	Strain-gage (Full-, half and quarter-bridge, incl. shunt calibration) for strain gage application	14 ranges from ± 0.5 to 1000 mV/V (@ 5 V _{DC} excitation)	✓	BW: 30 kHz	0 to 12 V _{DC}
		Voltage up to ± 10 V	15 ranges from ± 2.5 mV to ± 10 V			
		ICP via MSI-BR-ACC	7 ranges from ± 0.25 mV to ± 10 V			
		Voltage up to 200 V via MSI-BR-V-200	6 ranges from ± 10 to ± 200 V			
		Thermocouple via MSI-BR-TH-x	full range of TC type			
		Pt100, Pt200, Pt500, Pt1000, Pt2000 and resistance via MSI-BR-RTD	-200 °C to 1000 °C and 0 to 6.5 kOhm			
MDAQ-SUB-BRIDGE-D Connector: DB-9 	8	Strain-gage (Full-, and half bridge) for strain gage sensors	14 ranges from ± 0.5 to 1000 mV/V (@ 5 V _{DC} excitation)	✓	BW: 30 kHz HP: 0.16 Hz	+15 V _{DC} and 0 to 12 V _{DC}
		Voltage up to ± 10 V	15 ranges from ± 2.5 mV to ± 10 V			
		ICP, via MSI-BR-ACC	7 ranges from ± 0.25 mV to ± 10 V			
		Voltage up to 200 V via MSI-BR-V-200	6 ranges from ± 10 to ± 200 V			
		Thermocouple via MSI-BR-TH-x	full range of TC type			
		Pt100, Pt200, Pt500, Pt1000, Pt2000 and resistance via MSI-BR-RTD	-200 °C to 1000 °C and 0 to 6.5 kOhm			
MDAQ-SUB-V-200-D Connector: DB-9 	8	Voltage up to ± 200 V	13 ranges from ± 0.125 to ± 200 V	✓	BW: 300 kHz	± 15 V _{DC} and 0 to 12 V _{DC}
		ICP, via MSI-V-ACC	7 ranges from ± 0.25 mV to ± 10 V			
		Pt100, Pt200, Pt500, Pt1000, Pt2000 and resistance via MSI-V-RTD	-200 °C to 1000 °C and 0 to 6.5 kOhm			
		<i>Note: for safety reasons, max. 120 V_{DC} or 50 V_{AC} are allowed at this connector</i>				
MDAQ-SUB-V-200-BNC Connector: BNC 	8	Voltage up to ± 200 V	13 ranges from ± 0.125 to ± 200 V	-	BW: 300 kHz	-
		<i>Note: for safety reasons, max. 120 V_{DC} or 50 V_{AC} are allowed at this connector</i>				
MDAQ-SUB-ACC-BNC Connector: BNC 	8	ICP® or voltage up to ± 10 V	8 ranges from ± 125 mV to ± 10 V	✓	BW: 300 kHz HP: 3.4 Hz	4 / 8 mA
		Single-ended or differential input and one highpass filter <i>3.4 Hz highpass filter for noise and shock response measurement</i>				
		MDAQ-SUB-ACC-BNC-S1 <i>0,16 Hz for structural and modal analysis, human body vibration measurement</i> <i>(rest same as MDAQ-SUB-ACC-BNC)</i>				
MDAQ-SUB-ACC-A-BNC Connector: BNC 	8	ICP® or voltage up to ± 10 V	8 ranges from ± 125 mV to ± 10 V	✓	BW: 300 kHz HP: 0.16 Hz, 3.4 Hz	4 / 8 mA
		Single-ended input and two HP filters <i>0.16 Hz for structural and modal analysis, human body vibration measurement</i>				
		<i>3.4 Hz for noise and shock response measurement</i>				
MDAQ-SUB-ACC-A-MD Connector: Microdot 	8	ICP® or voltage up to ± 10 V	8 ranges from ± 125 mV to ± 10 V	✓	BW: 300 kHz HP: 0.16 Hz, 3.4 Hz	4 / 8 mA
		Single-ended input, two HP filters and sensor failure detection <i>0.16 Hz for structural and modal analysis, human body vibration measurement</i>				
		<i>3.4 Hz for noise and shock response measurement</i> Option: test signal input for all channels				

Main System

Power supply

DEWE-211 with standard external AC/DC power supply



Power supply pin assignment:

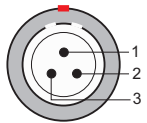

- 1 V+
- 2 GND
- 3 Ignition

Lemo EGJ.2B.303

Internal 250 W DC power supply

250 W DC power supply	
Input:	
Input range:	Rated 7 to 27 V _{DC} (max. 6 to 30 V _{DC}) (>10 V _{DC} required if ext. accessories are connected to the system)*
Input frequency:	DC
Output:	
Output power:	250 W
Output voltages:	+3.3 V (max. 15 A)
	+5 V (max. 15 A)
	+5 Vsb (max. 1.5 A)
	+12 V (max. 12 A)
	-12 V (max. 0.15 A)

*) For further information please see chapter 'DIP-switch operation'.

DIP-switch operation

DIP switch (ON = down)					
1	2	3	P	OFF-delay (all rails ON)	Hard-OFF (5 VSB)
OFF	OFF	OFF	P0	Standard PSU mode	
ON	OFF	OFF	P1	5 sec + 1 min AutoLatch*	1 min
OFF	ON	OFF	P2	1 min + 1 min AutoLatch*	NEVER
ON	ON	OFF	P3	1 min + 1 min AutoLatch*	1 min
OFF	OFF	ON	P4	15 min	1 min
ON	OFF	ON	P5	15 min	NEVER
OFF	ON	ON	P6	30 min	1 min
ON	ON	ON	P7	2 hours	NEVER

IMPORTANT: Always use the “Hibernate” feature, never use “Standby” as it can severely discharge your battery over extended periods of time.

NEVER use “hard-off = NEVER” settings unless you understand the risks of battery depletion. Even with safety limits in place, your battery might be not able to start your engine. “Hard-off=NEVER” keeps your 5 VSB rail on at all times.

***AutoLatch** is active during the first 60 sec. of PC operation (and only during the first 60 seconds). For example, if ignition is turned ON and then OFF right away, M4-ATX will latch ignition in ON position for the next 60 seconds, allowing your operating system to fully come up. This will prevent disk drive corruption or systems that remain hung in the ON position. After the first 60 seconds of system operation, the AutoLatch feature will be removed and system will shut down at as governed by the “OFF-delay” setting.

P0: In this mode, the M4-ATX behaves like a regular ATX power supply. If J6 is connected to the motherboard, M4-ATX will also send a gratuitous “ON pulse” to the motherboard right after power is first applied.

P1 (recommended): Sends ON pulse to motherboard when ignition is ON for more than 5 seconds, sends OFF pulse to motherboard 5 seconds after ignition is turned off. Waits another 60 seconds and then shuts down 5 VSB to conserve battery. In this mode, the M4-ATX consumes less than 0.5 mA. This is our recommended setting.

Power challenges in a vehicle PC:

One of most difficult tasks of operating a PC in a vehicle is power consumption while the computer is OFF. Even when your computer is OFF or in suspend, it will still consume about 50-150 mA on the 5 VSB rail. No matter how big your battery is, you will eventually drain it if proper actions are not taken.

The M4-ATX is addressing these issues by cutting off the 5 VSB rail after a pre-defined amount of time (see Hard-OFF). During Hard-OFF if the battery level drops below 11.2 V for more than one minute, M4-ATX will shut down and reactivate only when the input voltage is above 12 V.

Engine Cranks, under-voltage and over-voltage situations:

Another difficult task is maintaining stable power to your PC. While car batteries are rated at 12 V, they actually provide voltages in between 8-16 V (engine cranks) or as high as 80 V (load dump). Most times, your battery will stay at 13.5 V but extra precautions need to take place in order to prevent such situations. M4-ATX operates as low as 6 V and as high as 30 V while providing strict regulation as well as input voltage clamping and reverse protection.

Main System

Mode of operation

- 1) Ignition = OFF. Nothing happens. M4-ATX is waiting for ignition signals.
- 2) Ignition = ON. M4-ATX waits for few seconds then turns on the 5 VSB rail. After another second M4-ATX sends an "ON" signal to the motherboard via the 2 wires connected to the motherboard's ON/OFF pins. The motherboard will turn ON and your system should start booting. The Ignition state will be latched for 60 more seconds so that the motherboard will have a change to come up in a clean manner.
- 3) Ignition = ON. Your computer will remain ON.
- 4) Ignition = OFF. M4-ATX waits for "OFF-delay" in seconds (see jumper chart) and then it turns the motherboard OFF by sending a signal to the motherboard's ON/OFF switch. Your computer should turn off gracefully (shutdown procedure). After shutdown, 5 VSB will still be provided for another "Hard-OFF" seconds. In the event where the shutdown process is longer than "HARDOFF" (Operating System gets frozen, etc), power will be shut down hard, turning off all power rails. During the Hard-OFF procedure, the battery levels will be constantly monitored to prevent deep discharge situations.
- 5) M4-ATX will go to step 1, if ignition is turned ON again.

NOTE: When all dip switches are off, M4-ATX acts as a regular power supply. M4-ATX will also send a gratuitous "ON" pulse (to the ON/OFF motherboard pins, should you have a wire harness connected to it) when power is applied for the first time. Do not connect the on/off switch if you don't want your PC to be started automatically.

DEWESoft™

DEWESoft™ Software Turns our Hardware into a Powerful Data Acquisition System



Our award-winning data acquisition package is second to none when it comes to both pure recording power and ease of use. Normally it is a difficult balancing act to provide lots of capability and performance, without making the user interface cumbersome and hard to learn. But with careful and innovative design, we have done exactly that!

The software can act as a simple multi-meter or recorder as well as a sophisticated combustion analyzer or power analyzer. Or anything in between these extremes, like a FFT analyzer, transient recorder, etc.

Over 10 years DEWESoft™ evolved into a great data acquisition software and is Nr.1 in synchronous acquisition of vastly different signals like analog, digital, CAN, GPS, PCM, counter, video, etc. In 2010 with the release of version 7, DEWESoft™ takes a big step toward become a very powerful data analysis tool for a wide range of test & measurement applications. Since many years you can utilize math channels in the measure mode for online calculations. Starting with version 7.0, captured data can be re-calculated in the analyze mode using the large suite of calculation (math) functions available in the measure mode. This eliminates the CPU performance limitations and thus provides unlimited offline calculation power.

Example: Performing a 10th order notch filter on 128 channels being sampled at 200 kS/s each. This is not possible online. But in analyze mode it's easy. Simply record the data and then filter it afterwards (math functions are non-destructive, i.e., they do not affect the raw channels).

Another important new feature is the sequencer which provides a way to automate test procedures.

Key Features of DEWETRON systems running DEWESoft™

- Fast and easy setup
- Perfect sync of vastly different signals like analog, digital, counter, CAN, XCP, GPS, Video, ARINC, 1553, etc.
- Powerful online data processing, MATH functions, filters, statistics, reference curves
- Attractive online display of all kind of data, creation of displays is a matter of seconds
- Analog, digital or CAN data output; powerful function generator, alarms, CAN messages
- Build test procedures in a form of workflow diagram by means of sequencer
- Fast data analysis, reload GByte files in seconds
- Post processing, large suite of calculation (math) functions

Hardware Support

DEWESoft™ supports DEWETRON hardware cards as well as some third-party cards, like Spectrum cards for transient recording. Multiple cards of the same family are supported for high channel counts.

There is also a huge range of DEWETRON signal conditioners which are all perfectly implemented into the software.

Besides the analog inputs DEWESoft™ supports the digital I/Os, counters and CAN interfaces of DEWETRON hardware.

To acquire video streams in sync with the analog data there is a selection of DEWE-CAM cameras.

Further bus systems like PCM telemetry, XCP, ARINC, 1553, etc. are supported, too. DEWETRON offers the appropriate hardware for all of these.

For position and speed measurements there is a choice of high performance DEWE-VGPS sensors. Or use low-cost sensor which is NMEA compatible for simple position plotting and mapping applications.



DAQx modules

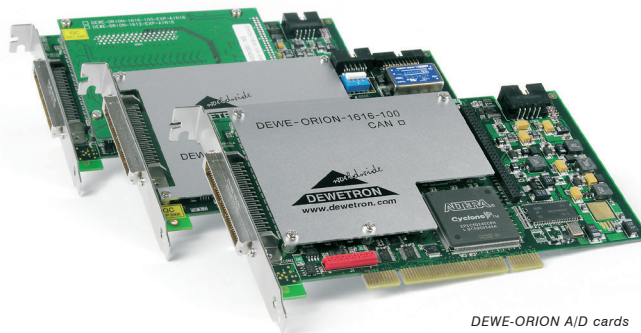

DEWE-ORION A/D cards

Sensor Database and TEDS (Technical Electronic Data Sheet)

The DEWESoft™ data acquisition software suite was developed especially for measurement technicians, thus simple sensor “connection” is a major topic. Basic settings like sensor setup are easily done. TEDS technology of newer sensors is supported on both the hardware and software side, so that all settings follow automatically, preventing user errors and saving a huge amount of time. For sensors without TEDS, there are numerous options for manual scaling as well as an integrated sensor database to make settings as efficient as possible.

#	Group	Sensor type	Serial number	Scale type	Transfer curve	Recal. date
1	Current	B0133	A_En_R01226-X	Polynom	Yes	01.04.2011
2	Current	B0133	A_En_R01226-Y	Polynom	Yes	01.04.2011
3	Current	B0133	A_En_R01226-Z	Polynom	Yes	01.04.2011
4	Beschl_Enitan	B0132	A_En_R01229-X	Linear	No	21.05.2011
5	Wegaufl. Megaton	M101	328947	Linear	No	14.09.2010
6	Beschl_FGP	FGP	254.758	Linear	No	22.11.2010
7	Beschl_FGP	FGP	254.759	Linear	No	22.11.2010
8	Beschl_Enitan	B0131	A_En_R01233-Y	Linear	No	01.01.2020
9	Beschl_Enitan	B0131	A_En_R01233-Z	Linear	No	01.01.2020
10	Beschl_Enitan	B0360	A_En_W98318-X	Linear	No	01.01.2020
11	Beschl_Enitan	B0360	A_En_W98318-Y	Linear	No	01.01.2020

Video Recording

A camera is a perfect sensor for many applications and a lot of people like to use it in their data acquisition. Video is a useful test documentation, providing a visual record of the test conditions and setup. I can also be used for more in-depth analysis, as you can imagine. There is nothing quite like seeing your data replayed with synchronized video – this DEWETRON innovation provides a whole new level of context and understanding of your test data than you could ever imagine.



3D Graph

In the properties panel there is a function that allows you to edit the properties of the selected display, and to create new displays, and rearrange them. You can rename any display, and select a different icon for it. Of course you can add sub-displays to any main display.

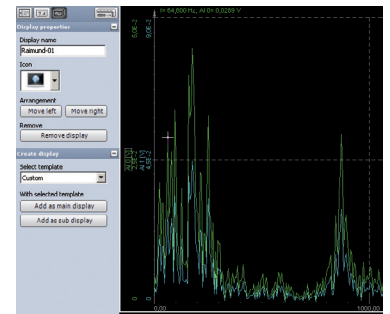

Display Screens

One of the most powerful and yet easy to use aspect of DEWESoft™ is the creation of displays. Of course a few standard displays like Recorders, Oscilloscope, FFT, Meters, Bars, 2D and 3D graphs, etc. are built-in for you. But this is only the beginning. You simply can create custom displays according to the needs of specific test.

Project Setup

The project files setup the measurement instruments in seconds including complete hardware setup, measurement configuration, and sensor calibration.

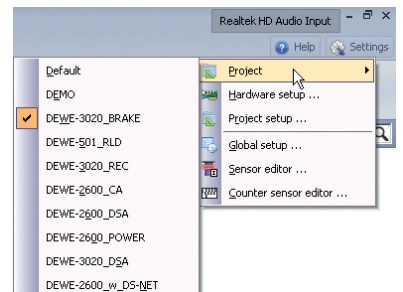

Since DEWESoft version 7 you can create “Projects” at the hardware setup screen level, where each project contains all of the settings for any hardware that you own. You can have an unlimited number of hardware setups, which you can freely name and edit. When you start DEWESoft 7, it will automatically load the last hardware setup that you used, of course ... but if you have changed the hardware, you can simply choose a different project from the “Settings” menu, and a completely different hardware setup will be loaded.

Even when using the same hardware, projects allows using different folders for setup, data and exported files. So you can create John and George projects for different users and work without interfering or you can create e.g. Road-Load and DSA projects for different tasks.

Recording

You can control recording as simple as pressing the START, STORE and STOP buttons. But there are also versatile trigger options to e.g. only store data if a trigger event occurs or to store at a slow rate usually but store at a fast rate at a trigger event with definable pre- and post times.

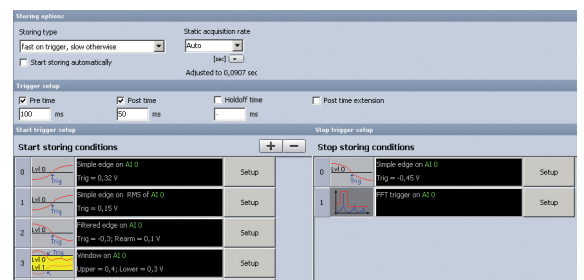

There is a large suite of calculation (math) functions which can be applied to any channels.

Analyze – Replay, Re-calculate, Export

In Analyze mode you can replay any captured data file, zoom in, make cursor measurements, print reports and export the data to a wide variety of formats, like Flexpro, Excel, Matlab, Diadem and many more.

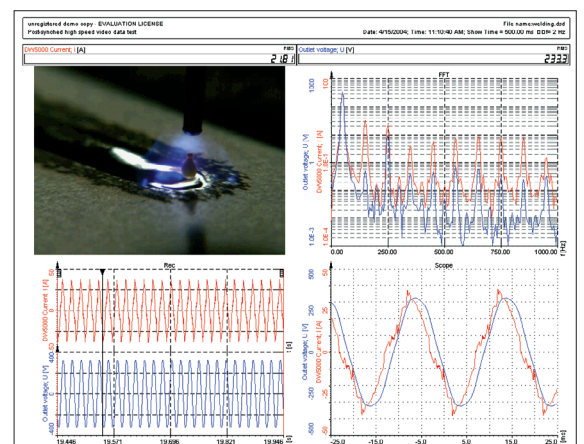

Since version 7 all the powerful math functions such as math formulas, filtering, statistics, power analysis, frequency response function, order tracking, torsional vibration, engine combustion analysis, sound analysis, human vibration analysis, and others can also be applied off-line to captured data. So you can simply store the raw data and do all the processing off-line, on any computer, anywhere. This allows you to work with the data as you were at the test bench or on the proving ground.

Notes

A/D & D/A Conversion

A/D Conversion

Please find information about the A/D conversion in the attached DEWE-ORION series manual. The latest version of the manual can be downloaded from:

<http://download.dewetron.com/dl/components/adboards>

Informations regarding different manufacturer's see the corresponding D/A card manual.

A/D & D/A Conversion

Notes

Internal Wiring

Please find information about the MDAQ amplifiers in the attached DEWE-MDAQ series manual. The latest version of the manual can be downloaded from:

<http://download.dewetron.com/dl/products/signal/mdaq>

Internal Wiring

Notes

CE-Certificate of conformity



Manufacturer:

DEWETRON Elektronische Messgeraete Ges.m.b.H.

Address:

**Parkring 4
A-8074 Graz-Grambach Austria**

Tel.: +43 316 3070 0

Fax: +43 316 3070 90

e-mail: sales@dewetron.com

http://www.dewetron.com

Name of product:

DEWE-211

Kind of product:

Data acquisition instrument

The product meets the regulations of the following EC-directives:

73/23/EEC

"Directive on the approximation of the laws of the Member States relating to electrical equipment designed for use within certain voltage limits amended by the directive 93/68/EEC"

89/336/EEC

"Directive on the approximation of the laws of the Member States relating to electromagnetic compatibility amended by the directives 91/263/EEC, 92/31/EEC, 93/68/EEC and 93/97/EEC"

The accordance is proved by the observance of the following standards:

L V E M C	Safety	IEC/EN 61010-1:1992/93 IEC/EN 61010-2-031	IEC 61010-1:1992/300 V CATIII PoI. D. 2 IEC 1010-2-031
	Emissions	EN 61000-6-4	EN 55011 Class B
	Immunity	EN 61000-6-2	Group standard

Graz, April 28, 2010

Place / Date of the CE-marking

Dipl.-Ing. Roland Jeutter / Managing director

Notes
