



Automotive
Energy & Power Analysis
Aerospace & Defense
Transportation
General Test & Measurement

DEWE-512

Technical reference manual



Re-inventing Data Acquisition



Copyright © DEWETRON elektronische Messgeraete Ges.m.b.H.

This document contains information which is protected by copyright. All rights are reserved. Reproduction, adaptation, or translation without prior written permission is prohibited, except as allowed under the copyright laws.

All trademarks and registered trademarks are acknowledged to be the property of their owners.

Thank you!

Thank you very much for your investment in DEWETRON's unique data acquisition systems. These are top-quality instruments which are designed to provide you years of reliable service. This guide has been prepared to help you get the most from your investment, starting from the day you take it out of the box, and extending for years into the future.

This guide includes important startup notes, as well as safety notes and information about keeping your DEWETRON system in good working condition over time.

We strongly suggest that you read this entire manual, especially the safety and care sections, as well as to avoid damaging your DEWETRON system.

What is the DEWE-512?

This product is used for measuring of different physical and/or electrical sizes (depending on model or configuration). The connection is depending on model or configuration and takes place via safety banana plugs, BNC connectors ($\pm 50V$ max.), D-SUB connectors ($\pm 50V$ max.), thermocouple connectors ($\pm 50V$ max.), BINDER® connectors ($\pm 50V$ max.) or LEMO® connectors.

Preface

Notes

Content

General Information, Safety Instructions	7
Training	7
Calibration.....	7
Support	7
Service/repairs	7
Warranty Information	8
Printing History.....	8
Safety symbols in the manual	9
General safety and hazard warnings for all DEWETRON systems	10
Windows updates and antivirus/security software	13
Problematic network stacks	13
Environmental Considerations	13
Blockdiagram of the internal signal processing	14
First steps	15
Main System	17
DEWE-512 - Standard instrument without display.....	17
System specifications	17
Connectors	18
DAQ series modules overview	22
MDAQ series amplifiers overview.....	24
Power supply	26
Software	33
DEWESoft.....	33
A/D Conversion	A1
Internal Wiring	B1
CE-Certificate of conformity	C1

Table of content

Training

DEWETRON offers training at various offices around the world several times each year. DEWETRON headquarters in Austria have a very large and professional conference and seminar center, where training classes are conducted on a regular basis starting with sensors and signal conditioning, A/D technology and software operation. For more information about training services, please visit:
<http://www.dewetron.com/support/training>

Dewetron Inc. in the USA also has a dedicated training facility connected to its headquarters, located in Rhode Island. For more information about training services in the US, please visit:
<http://www.dewamerica.com/support/training>

Calibration

Every instrument needs to be calibrated at regular intervals. The standard norm across nearly every industry is annual calibration. Before your DEWETRON data acquisition system is delivered, it is calibrated at our DEWETRON headquarter. Each of this system is delivered with a certificate of compliance with our published specifications. Detailed calibration reports from our calibration system are available for purchase with each order. We retain them for at least one year, so calibration reports can be purchased for up to one year after your system was delivered.

Support

DEWETRON has a team of people ready to assist you if you have any questions or any technical difficulties regarding the system. For any support please contact your local distributor first or DEWETRON directly.

For Asia and Europe, please contact:

DEWETRON Ges.m.b.H.
Parkring 4
A-8074 Graz-Grambach
AUSTRIA
Tel.: +43 316 3070
Fax: +43 316 307090
Email: support@dewetron.com
Web: <http://www.dewetron.com>

The telephone hotline is available
Monday to Friday between
08:00 and 17:00 CET (GMT +1:00)

Service/repairs

The Team of DEWETRON also performs any kinds of repairs to your system to assure a safe and proper operation in future. For information regarding service and repairs please contact your local distributor first or DEWETRON directly.

For the Americas, please contact:

DEWETRON, Inc.
10 High Street, Suite K
Wakefield, RI 02879
U.S.A.
Tel.: +1 401 284 3750
Toll-free: +1 877 431 5166
Fax: +1 401 284 3755
Email: support@dewamerica.com
Web: <http://www.dewamerica.com>

The telephone hotline is available
Monday to Friday between
08:00 and 17:00 GST (GMT -5:00)

Notice

The information contained in this document is subject to change without notice.

DEWETRON elektronische Messgeraete Ges.m.b.H. (DEWETRON) shall not be liable for any errors contained in this document. DEWETRON MAKES NO WARRANTIES OF ANY KIND WITH REGARD TO THIS DOCUMENT, WHETHER EXPRESS OR IMPLIED. DEWETRON SPECIFICALLY DISCLAIMS THE IMPLIED WARRANTIES OF MERCHANTABILITY AND FITNESS FOR A PARTICULAR PURPOSE. DEWETRON shall not be liable for any direct, indirect, special, incidental, or consequential damages, whether based on contract, tort, or any other legal theory, in connection with the furnishing of this document or the use of the information in this document.

Warranty Information

A copy of the specific warranty terms applicable to your DEWETRON product and replacement parts can be obtained from your local sales and service office.

Restricted Rights Legend

Use austrian law for duplication or disclosure.

DEWETRON GesmbH
Parkring 4
A-8074 Graz-Grambach / Austria

Printing History

Please refer to the page bottom for printing version.

Copyright © DEWETRON elektronische Messgeraete Ges.m.b.H.

This document contains information which is protected by copyright. All rights are reserved. Reproduction, adaptation, or translation without prior written permission is prohibited, except as allowed under the copyright laws.

All trademarks and registered trademarks are acknowledged to be the property of their owners.

Safety instructions

Safety symbols in the manual



Indicates hazardous voltages.

WARNING *Calls attention to a procedure, practice, or condition that could cause bodily injury or death.*

CAUTION *Calls attention to a procedure, practice, or condition that could possibly cause damage to equipment or permanent loss of data.*

WARNINGS

The following general safety precautions must be observed during all phases of operation, service, and repair of this product. Failure to comply with these precautions or with specific warnings elsewhere in this manual violates safety standards of design, manufacture, and intended use of the product. DEWETRON Elektronische Messgeraete Ges.m.b.H. assumes no liability for the customer's failure to comply with these requirements.

All accessories shown in this document are available as option and will not be shipped as standard parts.



*For safety reasons max. 50 V may be applied to the BNC input-connectors!
Refer to the regulation of maximum allowable touch potential.*

Safety instructions

Your safety is our primary concern! Please be safe!

General safety and hazard warnings for all DEWETRON systems

- Use this system under the terms of the specifications only to avoid any possible danger.
- Maintenance will be executed by qualified staff only.
- During the use of the system, it might be possible to access another parts of a more comprehensive system. Please read and follow the safety instructions provided in the manuals of all other components regarding warning and security advices for using the system.
- With this product, only use the power cable delivered or defined for the host country.
- DO NOT connect or disconnect sensors, probes or test leads, as these parts are connected to a voltage supply unit.
- The system is grounded via a protective conductor in the power supply cord. To avoid electric shocks, the protective conductor has to be connected with the ground of the power network. Before connecting the input or output connectors of the system, make sure that there is a proper grounding to guarantee potential free usage. For countries, in which there is no proper grounding, please refer to your local legally safety regulations for safety use.

DC systems: Every DC system has a grounding connected to the chassis (yellow/green safety banana plug).

- Please note the characteristics and indicators on the system to avoid fire or electric shocks. Before connecting the system, please carefully read the corresponding specifications in the product manual.
- The inputs are not, unless otherwise noted (CATx identification), for connecting to the main circuit of category II, III and IV.
- The power cord separates the system from the power supply. Do not block the power cord, since it has to be accessible for the users.
- DO NOT use the system if equipment covers or shields are removed.
- If you assume the system is damaged, get it examined by authorised personnel only.
- Any use in wet rooms, outdoors or in adverse environmental condition is not allowed!
Adverse environmental conditions are:
 - Moisture or high humidity
 - Dust, flammable gases, fumes or dissolver
 - Thunderstorm or thunderstorm conditions (except assembly PNA)
 - Electrostatic fields, et cetera.
- The measurement category can be adjusted depending on module configuration.
- Any direct voltage output is protected with a fuse against short cut and reverse-polarity, but is NOT galvanically isolated (except it is explicit marked on the system).
- The system must be connected and operated to an earthed wall socket at the AC mains power supply only (except for DC systems).
- Any other use than described above may damage your system and is attended with dangers like shortcut, fire or electric shocks.
- The whole system must not be changed, rebuilt or opened (except for changing DAQ, DAQP, PAD modules).

Safety instructions

- If you assume a more riskless use is not provided anymore, the system has to be rendered inoperative and should be protected against inadvertent operation. It is assumed that a more riskless operation is not possible anymore, if
 - the system is damaged obviously or causes strange noises.
 - the system does not work anymore.
 - the system has been exposed to long storage in adverse environmental.
 - the system has been exposed to heavy shipment strain.
 - DO NOT touch any exposed connectors or components if they are live wired. The use of metal bare wires is not allowed. There is a risk of short cut and fire hazard!
 - Warranty void if damages caused by disregarding this manual. For consequential damages NO liability will be assumed!
 - Warranty void if damages to property or persons caused by improper use or disregarding the safety instructions.
 - Unauthorized changing or rebuilding the system is prohibited due to safety and permission reasons (CE). Exception: changing modules like DAQ, DAQP or PAD.
 - The assembly of the system is equivalent to protection class I. For power supply, only the correct power socket of the public power supply must be used, except the system is DC powered.
 - Be careful with voltages >25 VAC or >35 VDC! These voltages are already high enough in order to get a perilous electric shock by touching the wiring.
 - The product heats during operation. Make sure there is adequate ventilation. Ventilation slots must not be covered!
 - Only fuses of the specified type and nominal current may be used. The use of patched fuses is prohibited.
 - Prevent using metal bare wires! Risk of short cut and fire hazard!
 - DO NOT use the system before, during or shortly after a thunderstorm (risk of lightning and high energy overvoltage). An advanced range of application under certain conditions is allowed with therefore designed products only. For details please refer to the specifications.
 - Make sure that your hands, shoes, clothes, the floor, the system or measuring leads, integrated circuits and so on, are dry.
 - DO NOT use the system in rooms with flammable gases, fumes or dust or in adverse environmental conditions.
 - Avoid operation in the immediate vicinity of:
 - high magnetic or electromagnetic fields
 - transmitting antennas or high-frequency generators
- For exact values please refer to enclosed specifications.
- Use measurement leads or measurement accessories aligned to the specification of the system only. Fire hazard in case of overload!
 - Do not switch on the system after transporting it from a cold into a warm room and vice versa. The thereby created condensation may damage your system. Acclimatise the system unpowered to room temperature.
 - Do not disassemble the system! There is a high risk of getting a perilous electric shock. Capacitors still might be charged, even the system has been removed from the power supply.
 - The electrical installations and equipments in industrial facilities must be observed by the security regulations and insurance institutions.

Safety instructions

- The use of the measuring system in schools and other training facilities must be observed by skilled personnel.
- The measuring systems are not designed for use at humans and animals.
- Please contact a professional if you have doubts about the method of operation, safety or the connection of the system.
- Please be careful with the product. Shocks, hits and dropping it from already lower level may damage your system. For exact values please refer to enclosed specifications.
- Please also consider the detailed technical reference manual as well as the security advices of the connected systems.

This product has left the factory in safety-related flawless and proper condition.

In order to maintain this condition and guarantee safety use, the user has to consider the security advices and warnings in this manual.

EN 61326-3-1:2008

IEC 61326-1 applies to this part of IEC 61326 but is limited to systems and equipment for industrial applications intended to perform safety functions as defined in IEC 61508 with SIL 1-3.

The electromagnetic environments encompassed by this product family standard are industrial, both indoor and outdoor, as described for industrial locations in IEC 61000-6-2 or defined in 3.7 of IEC 61326-1. Equipment and systems intended for use in other electromagnetic environments, for example, in the process industry or in environments with potentially explosive atmospheres, are excluded from the scope of this product family standard, IEC 61326-3-1.

Devices and systems according to IEC 61508 or IEC 61511 which are considered as “operationally well-tried”, are excluded from the scope of IEC 61326-3-1.

Fire-alarm and safety-alarm systems, intended for protection of buildings, are excluded from the scope of IEC 61326-3-1.

CAUTION

- The system BIOS is protected by password. Any change in the BIOS may cause a system crash. When the system is booting, do not press ESC-button on keyboard. This may clear the BIOS settings and cause system faults.
- Any change in the file structure as deleting or adding files or directories might cause a system crash.
- Before installing software updates contact DEWETRON or your local distributor. Use only software packages which are released by DEWETRON. Further informations are also available in the internet (<http://www.dewetron.com>).
- After power off the system wait at least 10 seconds before switching the system on again. Otherwise the system may not boot correct. This prolongs also the life of all system components.

Windows updates and antivirus/security software

Before installing Windows software updates consult with DEWETRON for compatibility guidance. Please also keep in mind that the use of any antivirus or other security software may slow down your system and may cause data loss.

Problematic network stacks

Often intrusive IT software or network processes can interfere with the primary function of the DEWETRON system: to record data. Therefore we recommend strongly against the installation of IT/MIS software and running their processes on any DEWETRON data acquisition system, and cannot guarantee the performance of our systems if they are so configured.



Environmental Considerations

Information about the environmental impact of the product.

Product End-of-Life Handling

Observe the following guidelines when recycling a DEWETRON system:

System and Components Recycling

Production of these components required the extraction and use of natural resources. The substances contained in the system could be harmful to your health and to the environment if the system is improperly handled at its end of life! Please recycle this product in an appropriate way to avoid an unnecessary pollution of the environment and to keep natural resources.

This symbol indicates that this system complies with the European Union's requirements according to Directive 2002/96/EC on waste electrical and electronic equipment (WEEE). Please find further informations about recycling on the DEWETRON web site www.dewetron.com

Restriction of Hazardous Substances

This product has been classified as Monitoring and Control equipment, and is outside the scope of the 2002/95/EC RoHS Directive. This product is known to contain lead.

Signal processing

Blockdiagram of the internal signal processing

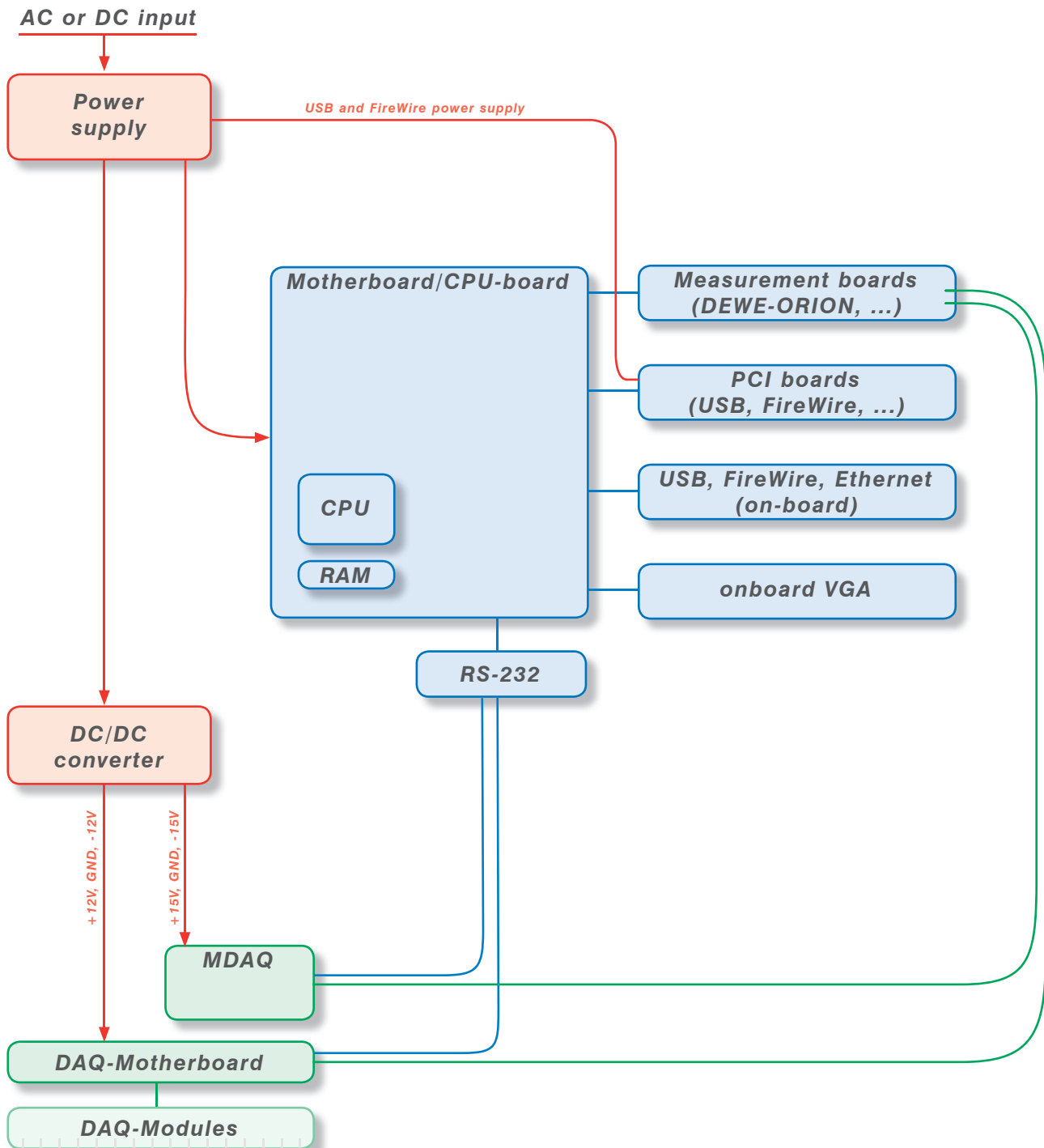

First steps

1



Power-on your system.

2

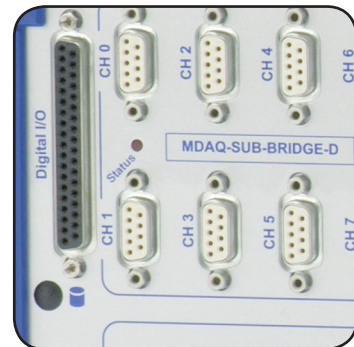

Connect your sensors to the system.

3

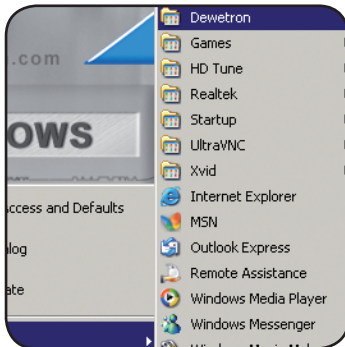

Run DEWESoft usually via "Start" > "Programs" > "Dewetron" > "DEWESoft x.x" > "DEWESoft x.x"

4

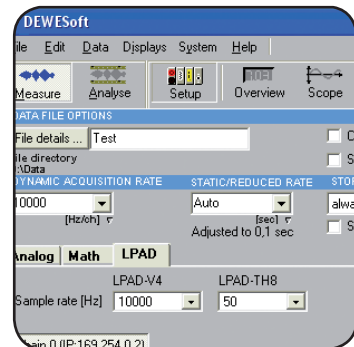

Start recording your data!

First steps

Notes

DEWE-512 - Standard instrument without display

- Portable data acquisition system
- Up to 32 channel differential voltage amplifier
- Up to 16 channels with isolation (in conjunction with DEWE-DAQ modules)
- Optional counter- / encoder inputs



System specifications

DEWE-512																
	MDAQ-DIRECT	MDAQ-V-10	MDAQ-V-100	MDAQ-SUB-V-200	MDAQ-SUB-ACC-x	MDAQ-SUB-ACC-A-x	MDAQ-SUB-BRIDGE	MDAQ-SUB-STG	MDAQ-BASE-5	MDAQ-BASE-10	MDAQ-FILT-5-BU	MDAQ-FILT-5-BE	MDAQ-FILT-5-BU-S1	MDAQ-FILT-10	MDAQ-FILT-10-S1	MDAQ-AAF4-5-BU
Channel 16 to 23 Channel 24 to 31	<input type="checkbox"/>	<input type="checkbox"/>	<input type="checkbox"/>	<input type="checkbox"/>	<input type="checkbox"/>	<input type="checkbox"/>	<input type="checkbox"/>	<input type="checkbox"/>	<input type="checkbox"/>	<input type="checkbox"/>	<input type="checkbox"/>	<input type="checkbox"/>	<input type="checkbox"/>	<input type="checkbox"/>	<input type="checkbox"/>	<input type="checkbox"/>
Channel 32 to 39 Channel 40 to 47	<input type="checkbox"/>	<input type="checkbox"/>	<input type="checkbox"/>	<input type="checkbox"/>	<input type="checkbox"/>	<input type="checkbox"/>	<input type="checkbox"/>	<input type="checkbox"/>	<input type="checkbox"/>	<input type="checkbox"/>	<input type="checkbox"/>	<input type="checkbox"/>	<input type="checkbox"/>	<input type="checkbox"/>	<input type="checkbox"/>	<input type="checkbox"/>
AC Power supply:	100 to 240 V _{AC} input <input type="checkbox"/> MPM-842P (400 W) <input type="checkbox"/> BEA-640 (400W)															
DC Power supply:	12 or 24 V _{DC} input <input type="checkbox"/> STC-12-300 (option 510-DC-12V) <input type="checkbox"/> STC-24-300 (option 510-DC-24V)															
Battery power supply: (option 510-PS-BAT)	18 to 24 V _{DC} input <input type="checkbox"/> XP-04 (320 W) with DC-123															
Operating temperature	-10 °C to +50 °C															
Storage temperature	-20 °C to +60 °C															
Humidity (operating)	10 % to 80 %, non condensing 5 % to 95 %, rel. humidity															
Vibration test* EN 60068-2-6	Shape Frequency range Acceleration Sweep rate Duration Test in 3 directions															
Vibration test* EN 60721-3-2 Class 2M2	Shape Frequency range Power spectral density Duration															
Shocktests* EN 60068-2-27	Shape Acceleration amplitude Duration Test in 3 axis, 3 shocks in each axis and direction															
Dimensions (W x D x H)	438.5 x 308 x 180.5 mm (17.3 x 12.1 x 7.1 in.)															
Weight	typ. 6 to 10 kg (13.2 to 22 lbs), depending on configuration															
*) tested with SSD disc																

Main System

Connectors

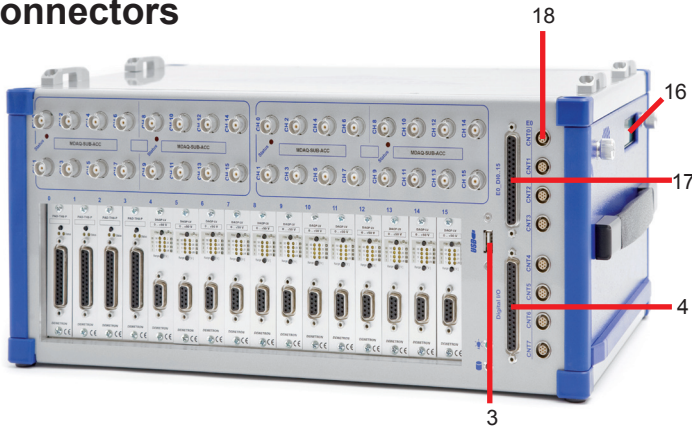

Connector overview:

- 1 Power-on switch
- 2 IEEE1394 interface connector
- 3 USB interface connectors
- 4 **Digital I/O connector**
- 5 **CAN interface**
- 6 **Power supply for accessories (12 V_{DC} / 1.8 A) Lemo EGG.1B.302**
- 7 Ethernet interface connectors
- 8 Ground connector
- 9 **EPAD interface**
- 10 VGA connector
- 11 PS/2 connector
- 12 Audio interface
- 13 RS-232 interface connector
- 14 WLAN connector
- 15 **Power supply input (Lemo FGJ.3B.302 - only DC version)**
- 16 Battery status display
- 17 **Optional expansion interface connector (Expansion Ex)**
- 18 **Optional counter inputs**

Typical DEWE-511 DC front view

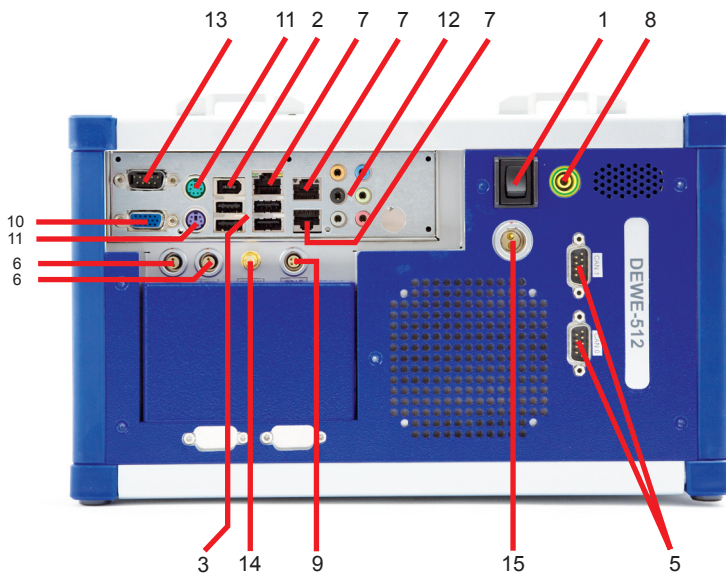

Typical DEWE-511 DC side view

Note: The location of the connectors might vary from system to system and depends on system configuration

Dimensions*

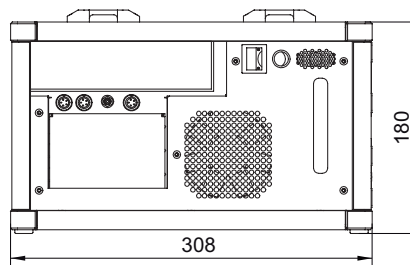
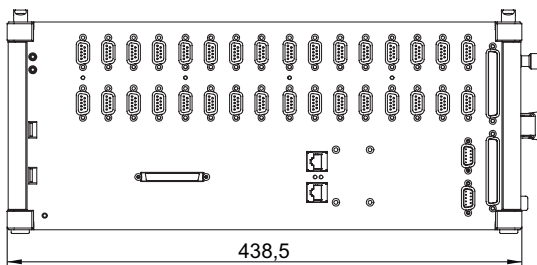

* Dimensions in mm
(1 inch = 25.4 mm)

1 Power-on switch

The power-on switch has to be used to switch on the system.

2 IEEE-1394 (FireWire®) connector

The IEEE-1394 interface connectors meets standard Firewire® pin assignment.

3 USB interface connectors (Universal Serial Bus)

The USB interface connectors meets standard USB pin assignment.

4 Digital I/O connector

This connector supports digital input and output lines of the built-in DEWE-ORION series board. If this board does not support digital I/O's, the connector is not available.

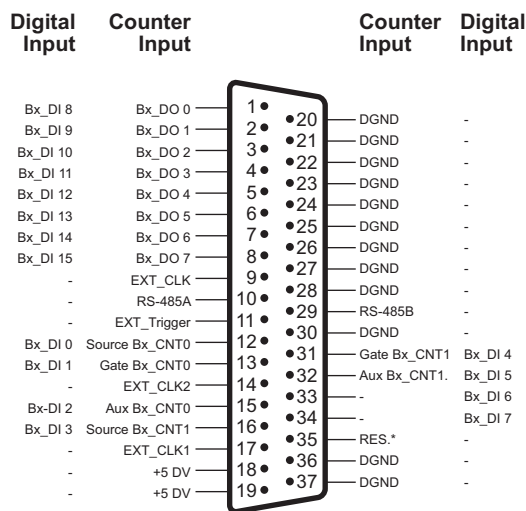

37-pin SUB-D connector



Note: Only available for standard systems using ORION-xxxx cards!

5 CAN connector (optional)

This connector supports the CAN signals of the built-in A/D board. If this board does not support CAN signals, the connector is not available.

CAN 0:

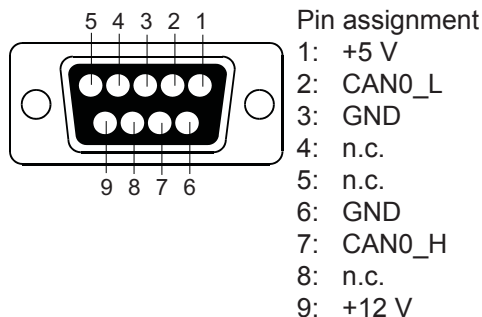

CAN 1:

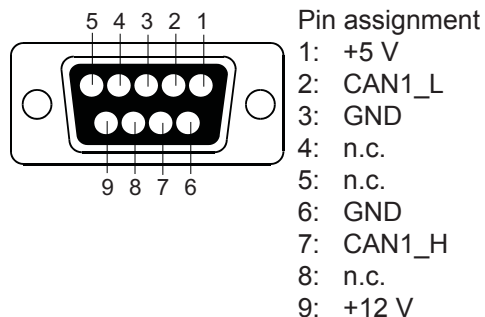

Main System

6 Power supply for accessories

To supply your accessories with 12 V_{DC}. Fused with an 1.5 A self-recovering fuse.

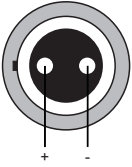

Lemo EGG.1B.302

Mating connector:

LEMO FGG.1B.302.CLAD52Z (for cable diameter 4.1 to 5.0 mm)

LEMO FGG.1B.302.CLAD62Z (for cable diameter 5.1 to 6.0 mm)

7 Ethernet connector

The DEWE-512 system supports 10/100/1000 BaseT Ethernet with standard RJ45 connector.

8 Ground connector

For some kind of measurements, it's necessary to give the system an additional ground connection.

9 EPAD connector (LEMO)

To connect DEWETRON EPAD modules to the system.

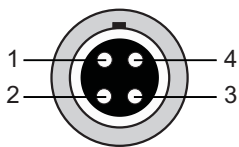

Lemo EGG.1B.304

Pin assignment

1: RS-485 A

2: RS-485 B

3: +12 V

4: GND

Shield is connected on housing

Mating connector:

LEMO FGG.1B.304.CLAD52Z (for cable diameter 4.1 to 5.0 mm)

LEMO FGG.1B.304.CLAD62Z (for cable diameter 5.1 to 6.0 mm)

10 VGA connector

The VGA connector meets standard VGA pin assignment.

11 PS/2 mouse / keyboard connector

The mouse / keyboard connector could be used to connect a keyboard or an external PS/2 mouse. The connector meets standard PS/2 pin assignment.

13 RS-232 interface connector

The RS-232 interface connector meets standard RS-232 pin assignment.

14 WLAN connector

The DEWE-512 system supports 802.11b and 802.11g standards for Wireless LAN with max. speed of 54 MBit/s.

15 Power supply input connector

For details see chapter power supply.

17 Expansion interface connector (in conjunction with DEWE-ORION-xxxx boards)

The ORION expansion interface connector is installed in case the system is equipped with a 32 channel ORION card or a ORION card with counter expansion.

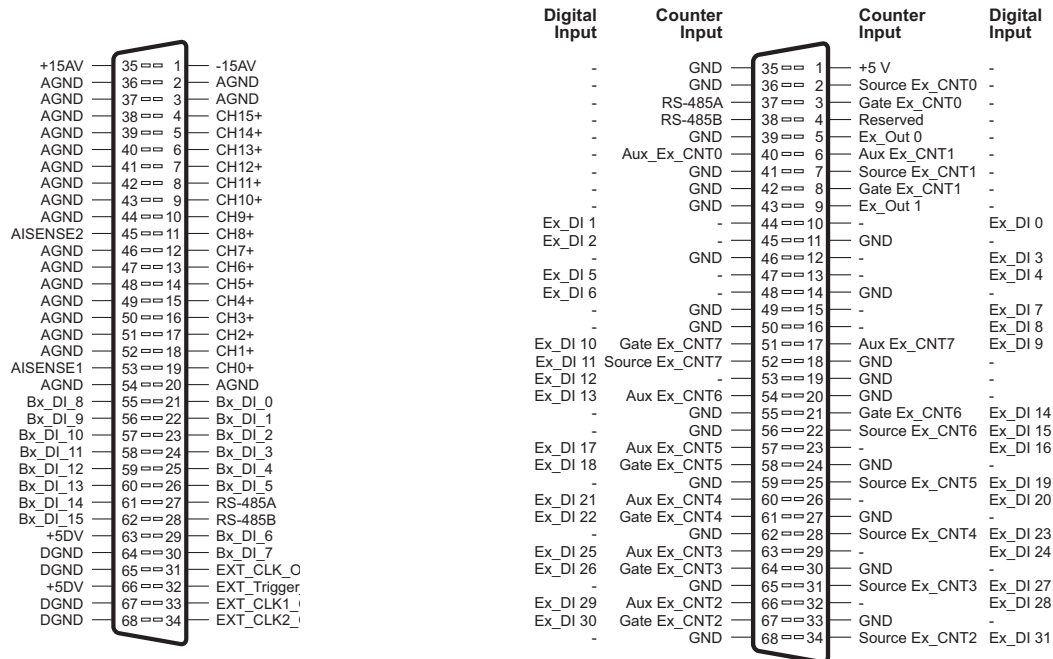

ORION card with 32 analog inputs
(ORION-3216-10x, ORION-3222-10x)

ORION card with counter expansion
(ORION-xxxx-x02, -x03, -x04, -x05)

68-pin Amplimite series
(AMP: 174339-5) SCSI II

68-pin Amplimite series
(AMP: 174339-5) SCSI II



Note: Only available for standard systems using ORION-xxxx cards!

18 Optional counter inputs (in conjunction with DEWE-ORION-xxxx boards)

- 1: Source Bx_CNT(n)
- 2: Aux_Bx_CNT(n)
- 3: Gate Bx_CNT(n)
- 4: Power GND
- 5: +5 V (max. 500 mA)
- 6: +12 V (max. 500 mA)
- 7: Signal GND
- n .. channels 0 to 1 of counter board

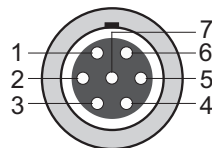

7-pin female LEMO connector
EGG.1B.307

Mating connector:
LEMO FGG.1B.307.CLAD52Z
(for cable diameter 4.1 to 5.0 mm)
LEMO FGG.1B.307.CLAD62Z
(for cable diameter 5.1 to 6.0 mm)









Cable to open end, 5 m long:
CTR-CBL-05

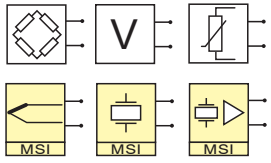



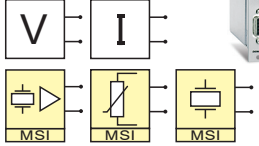
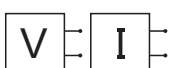



**For safety reasons max. 50 V may be applied to the BNC input-connectors!
Refer to the regulation of maximum allowable touch potential.**

Main System

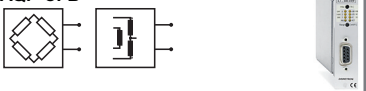
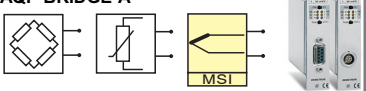
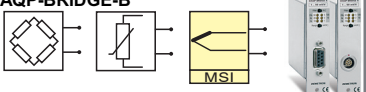
DAQ series modules overview

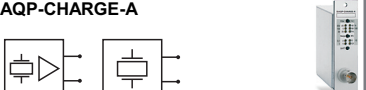
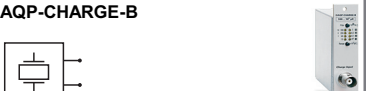
Module	Input type	Ranges	TEDS	Bandwidth (BW), Filters (LP = lowpass, HP = highpass)	Isolation (ISO), Overvoltage protection (OP)
Universal measurement					
DAQP-STG 	Strain gauge, bridge sensors Piezoresistive bridge Voltage Resistance Pt100, Pt200, Pt500, Pt1000, Pt2000 IEPEx [®] via MSI-BR-ACC Thermocouple via MSI-BR-TH-x Charge via MSI-BR-CH-50 Voltage via MSI-BR-V-200	± 0.1 to ± 1000 mV/V (@ 5 VDC _{exc}) ± 0.5 to 10000 mV/mA (@ 1 mA _{exc}) ± 500 μ V to ± 10 V 25 m Ω to 100 k Ω -200° C to 850° C ± 2.5 to ± 10000 mV full range of TC type up to 50000 pC up to ± 200 V	■	BW: 300 kHz LP: 10 Hz to 300 kHz	ISO: 350 V _{DC} OP: ± 50 V _{DC}
High voltage measurement					
DAQP-HV 	High voltage	± 20 to ± 1400 V	-	BW: 300 kHz LP: 10 Hz to 300 kHz	ISO: 1.8 kV _{RMS}
DAQP-HV-S3 	High voltage	± 20 to ± 1400 V	-	BW: 700 kHz LP: 10 Hz to 700 kHz	ISO: 1.8 kV _{RMS}
DAQP-DMM 	High voltage	± 10 to ± 1000 V	-	BW: 20/30 kHz LP: 10 Hz to 30 kHz	ISO: 1.5 kV _{RMS}
Voltage & current measurement					
DAQP-LV 	Voltage Current with external shunt IEPEx [®] via MSI-V-ACC Pt100, Pt200, Pt500, Pt1000, Pt2000 and resistance via MSI-V-RTD Charge via MSI-V-CH-50	± 10 mV to ± 50 V 20 mA / 5 A ± 10 mV to 10 V -200° C to 1000° C and 0 to 6.5 k Ω up to 50000 pC	■	BW: 300 kHz LP: 10 Hz to 300 kHz	ISO: up to 1 kV _{RMS} OP: 350 V _{DC}
DAQP-V 	Voltage Current with external shunt	10 mV to 50 V 20 mA / 5 A	-	BW: 50 kHz LP: 10 Hz to 50 kHz	ISO: up to 1 kV _{RMS} OP: ± 500 V _{DC}
DAQN-AIN 	Voltage	± 10 V (1:1 input)	-	-	OP: < ± 500 V (jumper selectable)
Current measurement					
DAQP-LA-SC 	Current <i>Note:</i> 5 A _{RMS} continuous	0.1 A to 30 A peak max. 5 A _{RMS} contin. current	-	BW: 300 kHz LP: 10 Hz to 300 kHz	ISO: 1.4 kV _{RMS}
DAQP-LA-B 	Current <i>Note:</i> typ. 20 mA application	2 mA to 600 mA	-	BW: 300 kHz LP: 10 Hz to 300 kHz	ISO: 1.4 kV _{RMS}

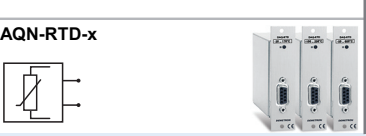
■ = standard

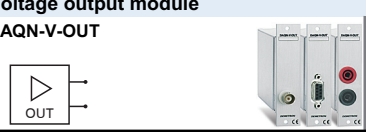



Module	Input type	Ranges	TEDS	Bandwidth (BW), Filters (LP = lowpass, HP = highpass)	Isolation (ISO), Overvoltage protection (OP)
Bridge / strain gauge and carrier frequency amplifier					
DAQP-CFB 	AC bridge, strain gauge <i>Note</i> : 5 kHz sine wave excitation	Bridge: 0.1 to 1000 mV/V	-	BW: DC to 2.3 kHz LP: 10 Hz to 1 kHz	OP: $\pm 10 V_{DC}$
	Inductive sensors, LVDT	Inductive: 5 to 1000 mV/V			
DAQP-BRIDGE-A 	Strain gauge, bridge sensors	± 1 to ± 50 mV/V (@ 5 VDC)	-	BW: 20 kHz LP: 10 Hz to 20 kHz	ISO: 350 V _{DC} OP: $\pm 10 V_{DC}$
	Potentiometric sensors	200 Ω to 10 k Ω			
DAQP-BRIDGE-B 	Strain gauge, bridge sensors	± 0.1 to ± 100 mV/V (@ 5 VDC)	■ ¹⁾	BW: 200 kHz LP: 10 Hz to 200 kHz	OP: $\pm 10 V_{DC}$
	Potentiometric sensors	200 Ω to 10 k Ω			
Charge / IEPE[®] measurement					
DAQP-ACC-A 	IEPE [®] sensors	± 50 mV to ± 5 V	-	BW: 0.5 Hz to 300 kHz LP: 1 to 300 kHz HP: 0.5 Hz and 5 Hz	-
DAQP-CHARGE-A 	Charge sensors IEPE [®] sensors <i>Note</i> : selectable integration and double integration	Charge: 5 to 50000 pC IEPE [®] : ± 5 mV to 5 V	-	BW: 0.1 Hz to 50 kHz LP: 100 Hz to 50 kHz HP: 0.1 Hz to 10 Hz	-
DAQP-CHARGE-B 	Charge sensors <i>Note</i> : selectable time constant for static sensors	± 100 to $\pm 1\,000\,000$ pC	-	BW: DC to 100 kHz LP: 10 Hz to 100 kHz HP: DC, 0.001 Hz to 0.5 Hz	ISO: 350 V _{DC}
Temperature measurement					
DAQN-THERM-x 	Thermocouple <i>Note</i> : internal CJC	K and J type (others on request) DAQN-THERM-1 K: -30 to 170 °C DAQN-THERM-2 K: -30 to 370 °C DAQN-THERM-3 K: 0 to 1000 °C DAQN-THERM-4 K: -100 to 1350 °C DAQN-THERM-5 J: -100 to 760 °C	-	BW: 4 Hz	ISO: 1 kV _{RMS}
DAQN-RTD-x 	Thermoresistors	Pt100 DAQN-RTD-1: -30 to 170 °C DAQN-RTD-2: -100 to 200 °C DAQN-RTD-3: -50 to 600 °C	-	BW: 10 Hz	-
Frequency measurement					
DAQP-FREQ-A 	Frequency	100 Hz to 200 kHz	-	BW: according to range Output response: 1.5 ms 30 ms 500 ms	ISO: 350 V _{DC}
Voltage output module					
DAQN-V-OUT 	Voltage output	1:1 output module with isolation Input voltage: ± 10 V Output voltage: ± 10 V	-	BW: 400 Hz	ISO: 240 V _{DC}

¹⁾ TEDS support for DAQP-BRIDGE-B revision 2 only

■ = standard

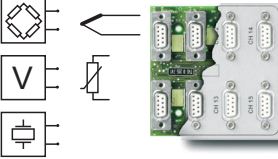
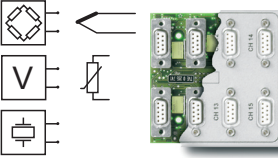
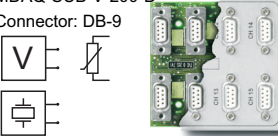
Main System

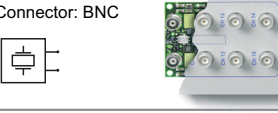
MDAQ series amplifiers overview

SUB Modules for MDAQ-BASE-x						
Module	# CH	Input type	Input ranges	TEDS	Bandwidth (BW), Highpass filters (HP)	Excitation
MDAQ-SUB-STG-D Connector: DB-9 	8	* Strain-gage (Full-, half and quarter-bridge, incl. shunt calibration) for strain gage application: * Voltage up to ±10 V: * ICP via MSI-BR-ACC: * Voltage up to 200 V via MSI-BR-V-200: * Thermocouple via MSI-BR-TH-x: * Pt100, Pt200, Pt500, Pt1000, Pt2000 and resistance via MSI-BR-RTD:	14 ranges from ±0.5 to 1000 mV/V (@ 5 V _{DC} excitation) 15 ranges from ±2.5 mV to ±10 V 7 ranges from ±0.25 mV to ±10 V 6 ranges from ±10 to ±200 V full range of TC type -200 °C to 1000 °C and 0 to 6.5 kOhm	■	BW: 30 kHz	0 to 12 V _{DC}
MDAQ-SUB-BRIDGE-D Connector: DB-9 	8	* Strain-gage (Full-, and half bridge) for strain gage sensors: * Voltage up to ±10 V: * ICP, via MSI-BR-ACC: * Voltage up to 200 V via MSI-BR-V-200: * Thermocouple via MSI-BR-TH-x: * Pt100, Pt200, Pt500, Pt1000, Pt2000 and resistance via MSI-BR-RTD:	14 ranges from ±0.5 to 1000 mV/V (@ 5 V _{DC} excitation) 15 ranges from ±2.5 mV to ±10 V 7 ranges from ±0.25 mV to ±10 V 6 ranges from ±10 to ±200 V full range of TC type -200 °C to 1000 °C and 0 to 6.5 kOhm	■	BW: 30 kHz HP: 0.16 Hz	+15 V _{DC} and 0 to 12 V _{DC}
MDAQ-SUB-V-200-D Connector: DB-9 	8	* Voltage up to ±200 V: * ICP, via MSI-V-ACC: * Pt100, Pt200, Pt500, Pt1000, Pt2000 and resistance via MSI-V-RTD: <i>Note:</i> <i>for safety reasons, max. 120 V_{DC} or 50 V_{AC} are allowed at this connector</i>	13 ranges from ±0.125 to ±200 V 7 ranges from ±0.25 mV to ±10 V -200 °C to 1000 °C and 0 to 6.5 kOhm	■	BW: 300 kHz	±15 V _{DC} and 0 to 12 V _{DC}
MDAQ-SUB-V-200-BNC Connector: BNC 	8	* Voltage up to ±200 V: <i>Note:</i> <i>for safety reasons, max. 120 V_{DC} or 50 V_{AC} are allowed at this connector</i>	13 ranges from ±0.125 to ±200 V	-	BW: 300 kHz	-
MDAQ-SUB-ACC-BNC Connector: BNC 	8	* ICP® or voltage up to ±10 V: Single-ended or differential input and one highpass filter 3.4 Hz highpass filter for noise and shock response measurement MDAQ-SUB-ACC-BNC-S1 0,16 Hz for structural and modal analysis, human body vibration measurement (rest same as MDAQ-SUB-ACC-BNC)	8 ranges from ±125 mV to ±10 V	■	BW: 300 kHz HP: 3.4 Hz	4 / 8 mA
MDAQ-SUB-ACC-A-BNC Connector: BNC 	8	* ICP® or voltage up to ±10 V: Single-ended input and two HP filters 0.16 Hz for structural and modal analysis, human body vibration measurement 3.4 Hz for noise and shock response measurement	8 ranges from ±125 mV to ±10 V	■	BW: 300 kHz HP: 0.16 Hz, 3.4 Hz	4 / 8 mA
MDAQ-SUB-ACC-A-MD Connector: Microdot 	8	* ICP® or voltage up to ±10 V: Single-ended input, two HP filters and sensor failure detection 0.16 Hz for structural and modal analysis, human body vibration measurement 3.4 Hz for noise and shock response measurement Option: test signal input for all channels	8 ranges from ±125 mV to ±10 V	■	BW: 300 kHz HP: 0.16 Hz, 3.4 Hz	4 / 8 mA

Main System

Power supply

AC power supply

400 W AC power supply		BEA-640	
Input:			
Input range:	90 to 260 V _{AC} (active PFC)		
Input frequency:	47 to 63 Hz		
Max. input current:	7 A (115 V _{AC}), 3.5 A (230 V _{AC})		
Output:			
Output power:	400 W continuous		
Output voltages:	+3.3 V (max. 28 A)		
	+5 V (max. 35 A)	-5 V (max. 0.5 A)	
	+5 Vsb (max. 2 A)		
	+12 V (max. 30 A)	-12 V (max. 0.8 A)	

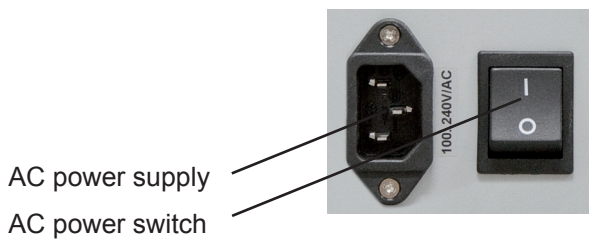

AC power supply

400 W AC power supply		MPM-842P	
Input:			
Input range:	100 to 240 V _{AC} (auto selecting)		
Input frequency:	47 to 63 Hz		
Max. input current:	8 A (115 V _{AC})		
Output:			
Output power:	400 W continuous (450 W peak)		
Output voltages:	+3.3 V (max. 22 A)		
	+5 V (max. 21 A)		
	+5 Vsb (max. 1.5 A)		
	+12 V (max. 22 A)	-12 V (max. 0.8 A)	

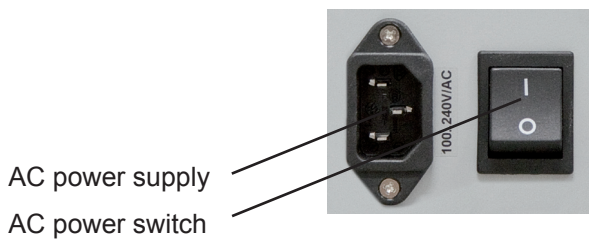

DC power supply

320 W DC power supply		STC-12300	
Input:			
Input range:	9 to 18 V _{DC} (12 V _{DC} nom.)		
Input frequency:	DC		
Max. input current:	50 A		
Output:			
Output power:	320 W		
Output voltages:	+3.3 V (max. 15 A)		
	+5 V (max. 30 A, min. 1.5 A)	-5 V	(max. 1 A)
	+5 Vsb (max. 2 A)		
	+12 V (max. 12 A, min. 0.2 A)	-12 V	(max. 0.8 A)

Power supply pin assignment:



Connector type
2-pin. male
LEMO EGJ.2B.302

DC power supply

320 W DC power supply		STC-24300	
Input:			
Input range:	18 to 36 V _{DC} (24 V _{DC} nom.)		
Input frequency:	DC		
Max. input current:	<20 A		
Output:			
Output power:	320 W		
Output voltages:	+3.3 V (max. 21 A)		
	+5 V (max. 40 A, min. 1.5 A)	-5 V	(max. 1 A)
	+5 Vsb (max. 2 A)		
	+12 V (max. 20 A, min. 0.2 A)	-12 V	(max. 0.8 A)

Power supply pin assignment:



Connector type
2-pin. male
LEMO EGJ.2B.302

Main System

Battery power supply

320 W DC power supply with XP-04 battery management	
Input:	
Input range:	18 to 24 V _{DC} (nom. 18 V _{DC})
Input frequency:	DC
Max. input current:	12 A
Output:	
Output power:	320 W with XP-04 battery management (only single DC-DC)
Output voltages:	+3.3 V (max. 10 A)
	+5 V (max. 10 A)
	+12 V (max. 12 A)
DC-023-12V option:	-12 V (max. 0.25A)

Power supply pin assignment:



Connector type
2-pin. male
LEMO EGJ.2B.302

There are 3 slots for hot-swappable smart batteries available in the system. Standard shipment includes 2 smart batteries, more can be ordered additionally (option BAT-95WH).

Optional cables:

C7502: LEMO 2B jack to LEMO 2B plug, 2 m. (used for connecting DEWE-512 to DEWE-DCDC-24-300-ISO)

C8502: LEMO 2B jack to banana plugs, 2 m.

External DC power supply (option)

DC/DC power supply	DEWE-DCDC-24-300-ISO
Input:	
Input voltage:	10 to 36 V _{DC} (the input is protected against wrong polarity)
Max. input current:	36 A @ 10 V _{DC} input voltage (15 A @ 24 V _{DC})
Input connector:	2-pin LEMO connector male, type: EGJ.2B.302
Output:	
Output voltages:	24 V
Output power:	300 W
Output current:	12.5 A
Output connector:	2-pin LEMO connector female, type: EGG.2B.302
Operating temperature:	
	-20 °C to 60 °C
Derating above 45 °C:	8 Watt/°C
Isolation voltage:	500 V _{DC}
Status LED:	Green LED indicates an output voltage > 21 V _{DC}
Dimensions: (W x D x H):	approx. 219 x 122 x 50 mm (8.6 x 4.8 x 2 in.)
Weight:	1.3 kg (2.9 lbs)
Power on sequence:	
First: Connect the system and the DCDC! Followed by the DCDC and the power supply connection.	

As an option the DEWE-512 is shipped with the DEWE-DCDC-24-300-ISO. This power supply serves galvanic isolated voltage with a wide input range from 10 to 36 V_{DC}. The output voltage is fixed with 24 V_{DC} with a maximum output power of 300 W.

Depending on the configuration, the DEWE-512 takes usually not more than 150 W. The typical power consumption is just around 70 W. However, if the batteries are empty the input current can go up to 12 Ampere which is an equivalent power consumption of 280 Watt! If the unit is supplied from a typical board supply of 12 V it needs an input current of 28 A!

If this high power is not available in the board supply please operate the DEWE-512 without or with charged batteries.

Dimensions*

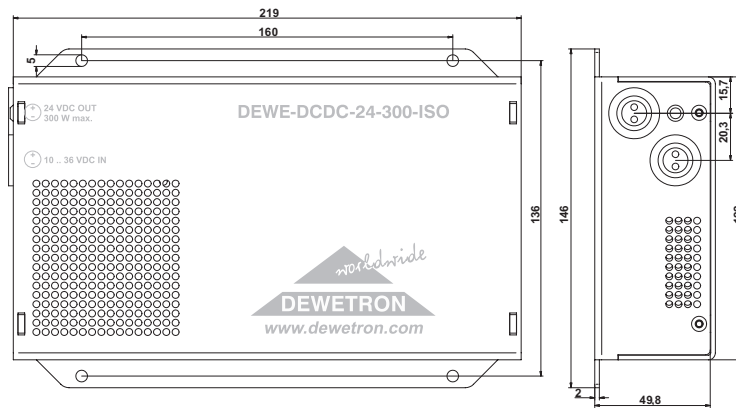

* Dimensions in mm
(1 inch = 25.4 mm)

Input connector



Pin assignment
1: 10 .. 36 V_{DC} input
2: GND

Lemo EGJ.2B.302

Output connector



Pin assignment
1: 24 V_{DC} output
2: GND

Lemo EGG.2B.302

Optional cables: C8502 LEMO 2B jack to banana plugs, 2 m.

Changing batteries (in conjunction with battery power supply)

The DEWE-512 DC comes with 3 batterie slots. To change the batteries, just open the screws on the right side of the system and flip down the sidepanel as shown in the picture below.

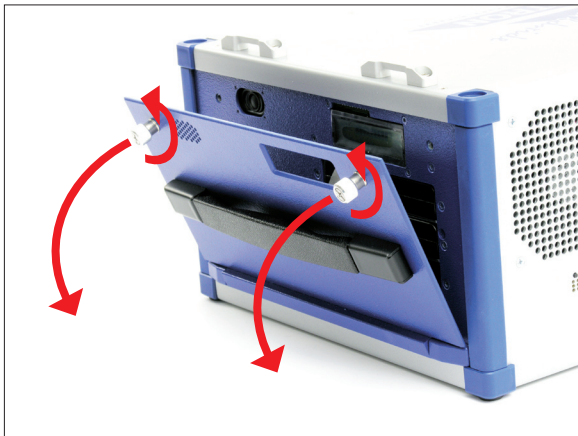

Note: If you don't use your DEWE-511 for a longer time, please make sure to remove your batteries and store them separately. Otherwise your system may get damaged!

Main System

LCD display for battery status (in conjunction with battery power supply)

The LCD Display contains two lines of information. One line is used for a bar graph displaying the amount of charge left in the battery system. The bar graph also indicates if the battery is charging or discharging.

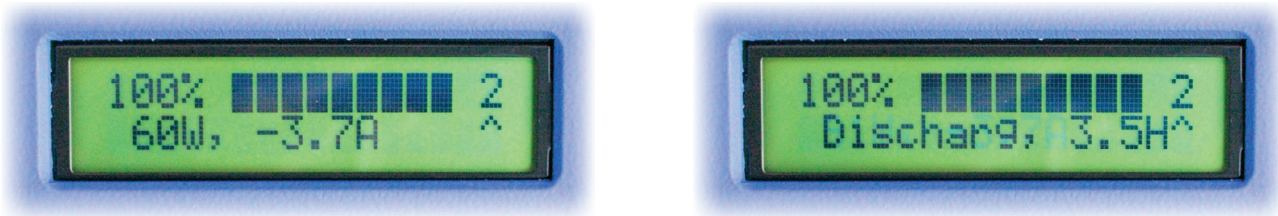

The second line of the LCD display can show the power consumption and the current entering or leaving the battery subsystem. The second line of the display can also show the time of fully charged when charging the batteries or the time to fully discharge the batteries when power to the system is being supplied by the batteries.

Smart battery packs



Smart battery packs are equipped with an integrated circuit which stores information (such as manufacturer, serial number, production date etc.) and monitors the current battery status in terms of discharge rate, predicted remaining capacity, temperature, voltage etc. The battery packs, supplied with every battery powered DEWETRON system, are even capable of displaying their charge state without a separate device. With the push of a button, a LED display on the battery pack shows the current charge state in 25% steps. An intelligent battery controller, integrated in our DEWETRON systems, takes care of the charging and discharging process in order to ensure maximum battery performance and life time.

External battery charger (optional)

External battery charger	CH5000A/E/U
Power supply:	
Input voltage:	90 to 260 VAC, 24V
Input current:	2.5 A
Mains Cord:	CH5000E - 220 V European 2-pin connector with ground recess
Dimensions (WxDxH):	180 mm x 92 mm x 58 mm
Weight:	ca. 250 g
Mating connector:	5-blade standard battery connector

From time to time, due to the aging process of the batteries, it is necessary to recalibrate the battery in order to retain the accuracy and reliability of the fuel gauge. This can be achieved with an external battery charger (BAT-CHARGER) which is optionally available. Another advantage of the BAT-CHARGER is that additional batteries can be recharged without being in the measurement unit. This allows the measurement unit to run non-stop without being connected to the power net, thanks to the hot-swap capability of the battery packs.

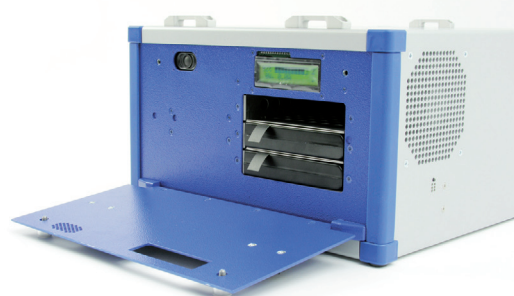

Main System

Notes

DEWESoft

DEWESoft turns your hardware into a powerful data acquisition system. Our award-winning data acquisition package is second to none when it comes to both pure recording power and ease of use. Normally this is a difficult balancing act: providing lots of capability and performance, without making the user interface hard to learn. But we've done it!

DEWESoft is the solution to acquire signals synchronous from different sources, display and store them together and offer the data for post analysis.



One of the most powerful and yet easy to use aspect of DEWESoft is the creation of displays. Of course, a few standard displays are built-in for you, like screens for these instruments:

- Recorder (vertical and horizontal recorder screens are included)
- Oscilloscope (free run, triggered, with 2D and 3D waterfall displays, and more)
- FFT (with selectable axes, line length, window, type, averaging, overlapping, weighting, and more)
- Video – Scalable video window with an assignable recorder graph below
- GPS – Track with background map, plus speed, distance, heading, etc.



Analyze Mode

REPLAY, EXPORT, SHARE DATA!

Here you can replay any captured data file, zoom in with the recorder graph cursors, make measurements, print in full color to any Windows printer, and export the data to a wide variety of formats compatible with today's popular analysis software packages, like Flexpro, Matlab, Excel, and many more.

You can even export a AVI video file from your recorded data to create "moving documentation." NO LICENSE is needed to use DEWESoft in the ANALYZE mode, so you can install the software on all your computers, or even distribute it to your customers, and they can install it. In this way, all of your colleagues and customers can replay your data files and do all of the functions that you can – just give them the data file to open.

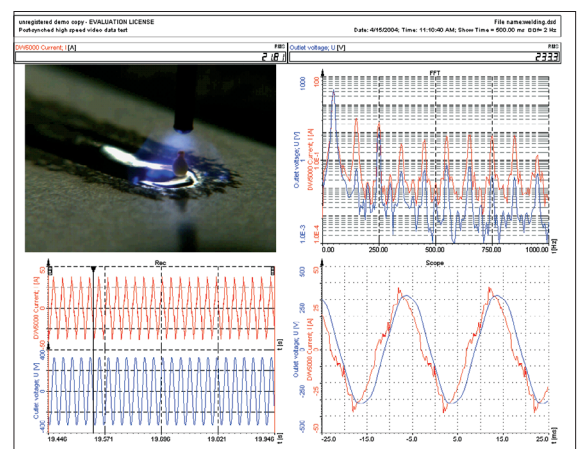

Notes

A/D & D/A Conversion

A/D Conversion

Please find information about the A/D conversion in the attached DEWE-ORION series manual. The latest version of the manual can be downloaded from:

<http://download.dewetron.com/dl/components/adboards>

Informations regarding different manufacturer's see the corresponding D/A card manual.

A/D & D/A Conversion

Notes

16 slot DEWE-MOTHERBOARD DAQ-MOTH-16-DE-x

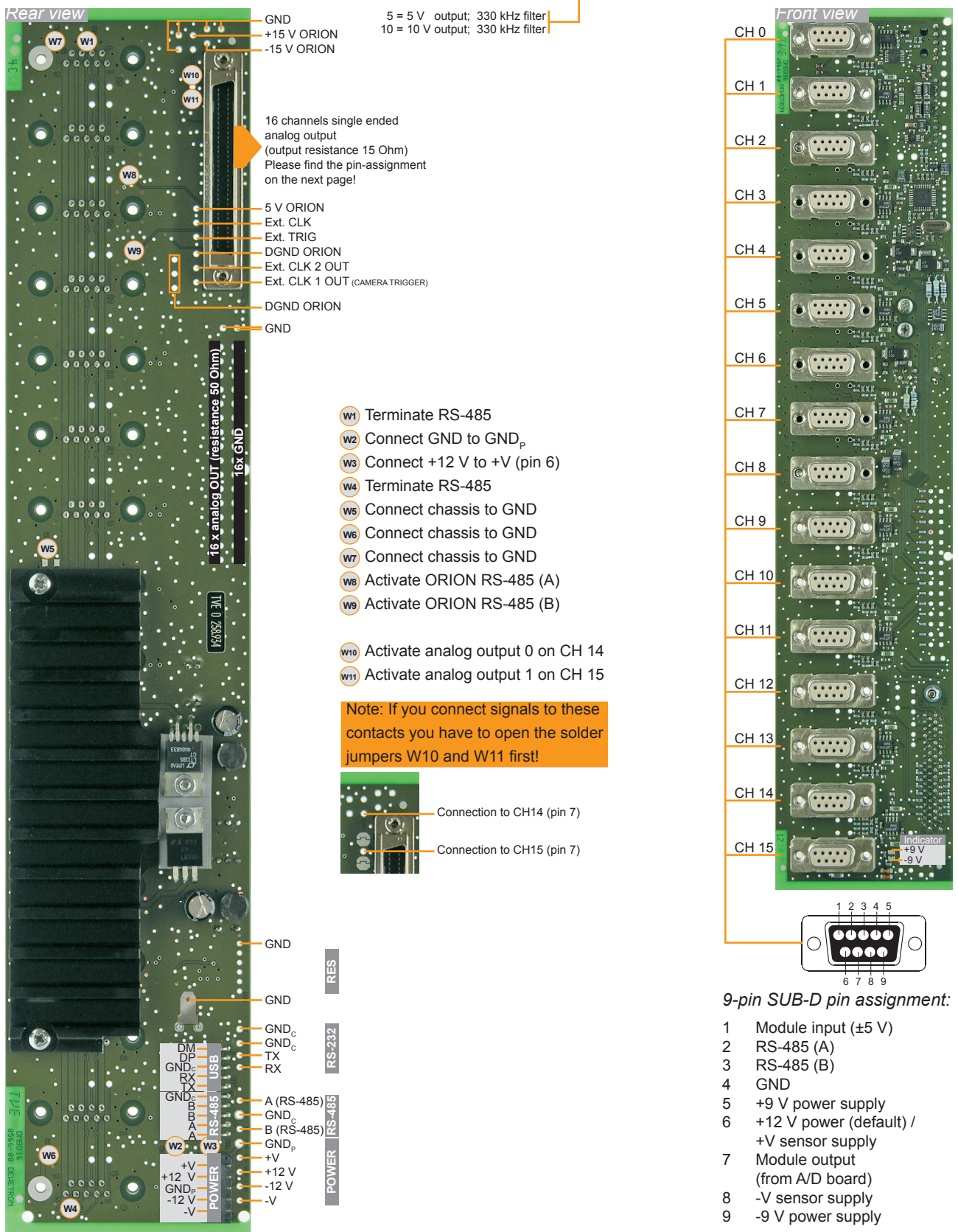

The 16 slot DEWE-MOTHERBOARD receives the ± 12 V_{DC} power supply via a DC/DC converter from the internal power supply.

Internal Wiring

Analog output connector pin-assignment

Connector for DEWE-ORION-1616 cards

+15 V	35 == 1	-15 V
AGND	36 == 2	AGND
AGND	37 == 3	AGND
AGND	38 == 4	CH15+
AGND	39 == 5	CH14+
AGND	40 == 6	CH13+
AGND	41 == 7	CH12+
AGND	42 == 8	CH11+
AGND	43 == 9	CH10+
AGND	44 == 10	CH9+
AISENSE2	45 == 11	CH8+
AGND	46 == 12	CH7+
AGND	47 == 13	CH6+
AGND	48 == 14	CH5+
AGND	49 == 15	CH4+
AGND	50 == 16	CH3+
AGND	51 == 17	CH2+
AGND	52 == 18	CH1+
AISENSE1	53 == 19	CH0+
AGND	54 == 20	AGND
DI8/DO0	55 == 21	DI0/Source(0)
DI9/DO1	56 == 22	DI1/Gate(0)
DI10/DO2	57 == 23	DI2/AUX_U_D(0)
DI11/DO3	58 == 24	DI3/Source(1)
DI12/DO4	59 == 25	DI4/Gate(1)
DI13/DO5	60 == 26	DI5/AUX_U_D(1)
DI14/DO6	61 == 27	RS-485A
DI15/DO7	62 == 28	RS-485B
+5 V	63 == 29	DI 6
DGND	64 == 30	DI 7
DGND	65 == 31	EXT_CLK
+5 V	66 == 32	EXT_Trigger
DGND	67 == 33	EXT_CLK1
DGND	68 == 34	EXT_CLK2

68-pin high density connector

Connector for DEWE-ORION-1624 cards

+15V	35 == 1	-15 V
AGND	36 == 2	AGND
AGND	37 == 3	AGND
CH. 15-	38 == 4	CH. 15+
CH. 14-	39 == 5	CH. 14+
CH. 13-	40 == 6	CH. 13+
CH. 12-	41 == 7	CH. 12+
CH. 11-	42 == 8	CH. 11+
CH. 10-	43 == 9	CH. 10+
CH. 9-	44 == 10	CH. 9+
CH. 8-	45 == 11	CH. 8+
CH. 7-	46 == 12	CH. 7+
CH. 6-	47 == 13	CH. 6+
CH. 5-	48 == 14	CH. 5+
CH. 4-	49 == 15	CH. 4+
CH. 3-	50 == 16	CH. 3+
CH. 2-	51 == 17	CH. 2+
CH. 1-	52 == 18	CH. 1+
CH. 0-	53 == 19	CH. 0+
AGND	54 == 20	AGND
NC.	55 == 21	NC.
NC.	56 == 22	NC.
NC.	57 == 23	NC.
NC.	58 == 24	NC.
NC.	59 == 25	NC.
NC.	60 == 26	NC.
NC.	61 == 27	RES.*
NC.	62 == 28	RES.*
+5 V	63 == 29	RES.*
DGND	64 == 30	RES.*
DGND	65 == 31	RES.*
+5 V	66 == 32	EXT-TRIGGER
DGND	67 == 33	SAMPLE CLOCK
DGND	68 == 34	NC.

* DONT CONNECT

68-pin high density connector

16 slot DEWE-MOTHERBOARD DAQ-MOTH-16-NI-x-U

5 = 5 V output; 330 kHz filter
 10 = 10 V output; 330 kHz filter
 USB interface on-board

Connector for National Instruments™ A/D cards

DGND	35 == 1	PFI 14/P2.6
DGND	36 == 2	PFI 112/P2.4
PFI 8/P2.0	37 == 3	PFI 9/P2.1
PFI 7/P1.7	38 == 4	DGND
PFI 15/P2.7	39 == 5	PFI 6/P1.6
PFI 13/P2.5	40 == 6	PFI 5/P1.5
PFI 4/P1.4	41 == 7	DGND
PFI 3/P1.3	42 == 8	+5 V
PFI 2/P1.2	43 == 9	DGND
DGND	44 == 10	PFI 1/P1.1
PFI 10/P2.2	45 == 11	PFI 0/P1.0
PFI 11/P2.3	46 == 12	DGND
P0.3	47 == 13	DGND
P0.7	48 == 14	+5 V
P0.2	49 == 15	DGND
DGND	50 == 16	P0.6
P0.5	51 == 17	P0.1
P0.0	52 == 18	DGND
DGND	53 == 19	P0.4
AO GND	54 == 20	APFI 0
AO GND	55 == 21	AO 1
AI GND	56 == 22	AO 0
AI 7	57 == 23	AI 15
AI 14	58 == 24	AI GND
AI GND	59 == 25	AI 6
AI 5	60 == 26	AI 13
AI 12	61 == 27	AI GND
AI Sense	62 == 28	AI 4
AI 11	63 == 29	AI GND
AI GND	64 == 30	AI 3
AI 2	65 == 31	AI 10
AI 9	66 == 32	AI GND
AI GND	67 == 33	AI 1
AI 0	68 == 34	AI 8

68-pin high density connector

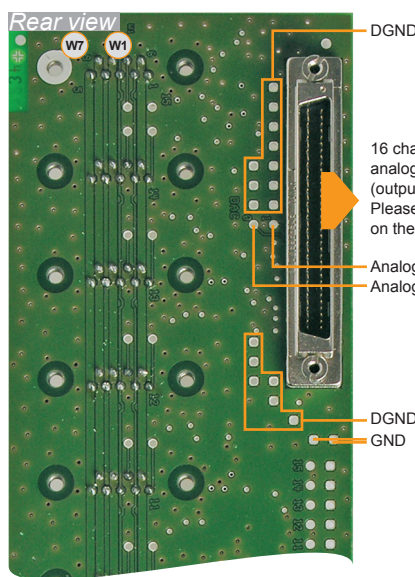

Internal Wiring

Please find information about the MDAQ amplifiers in the attached DEWE-MDAQ series manual. The latest version of the manual can be downloaded from:

<http://download.dewetron.com/dl/products/signal/mdaq>

Internal Wiring

Notes

CE-Certificate of conformity



Manufacturer:

DEWETRON Elektronische Messgeraete Ges.m.b.H.

Address:

**Parkring 4
A-8074 Graz-Grambach Austria**

Tel.: +43 316 3070 0

Fax: +43 316 3070 90

e-mail: sales@dewetron.com

http://www.dewetron.com

Name of product:

DEWE-512

Kind of product:

Data acquisition system

The product meets the regulations of the following EC-directives:

73/23/EEC

"Directive on the approximation of the laws of the Member States relating to electrical equipment designed for use within certain voltage limits amended by the directive 93/68/EEC"

89/336/EEC

"Directive on the approximation of the laws of the Member States relating to electromagnetic compatibility amended by the directives 91/263/EEC, 92/31/EEC, 93/68/EEC and 93/97/EEC"

The accordance is proved by the observance of the following standards:

L V E M C	Safety	IEC/EN 61010-1:1992/93 IEC/EN 61010-2-031	IEC 61010-1:1992/300 V CATIII PoI. D. 2 IEC 1010-2-031
	Emissions	EN 61000-6-4	EN 55011 Class B
	Immunity	EN 61000-6-2	Group standard

Graz, October 14, 2008

Place / Date of the CE-marking

Dipl.-Ing. Roland Jeutter / Managing director

Notes
