



Automotive  
Energy & Power Analysis  
Aerospace & Defense  
Transportation  
General Test & Measurement

# DEWE-2608

*Technical reference manual*



Test & Measurement Solutions



Copyright © DEWETRON elektronische Messgeraete Ges.m.b.H.

This document contains information which is protected by copyright. All rights are reserved. Reproduction, adaptation, or translation without prior written permission is prohibited, except as allowed under the copyright laws.

All trademarks and registered trademarks are acknowledged to be the property of their owners.

## Thank you!

Thank you very much for your investment in DEWETRON's unique data acquisition systems. These are top-quality instruments which are designed to provide you years of reliable service. This guide has been prepared to help you get the most from your investment, starting from the day you take it out of the box, and extending for years into the future.

This guide includes important startup notes, as well as safety notes and information about keeping your DEWETRON system in good working condition over time.

We strongly suggest that you read this entire manual, especially the safety and care sections, as well as to avoid damaging your DEWETRON system.

## What is the DEWE-2608?

This product is used for measuring of different physical and/or electrical sizes (depending on model or configuration). The connection is depending on model or configuration and takes place via safety banana plugs, BNC connectors ( $\pm 50V$  max.), D-SUB connectors ( $\pm 50V$  max.), thermocouple connectors ( $\pm 50V$  max.), BINDER® connectors ( $\pm 50V$  max.), SMB connectors ( $\pm 50V$  max.),  $\mu$ dot connectors ( $\pm 50V$  max.), LEMO® connectors or RJ-45 connectors.

# Preface

---

Notes

## Content

<b>General Information, Safety Instructions</b>	<b>7</b>
Training .....	7
Calibration.....	7
Support .....	7
Service/repairs .....	7
Warranty Information .....	8
Printing History.....	8
Safety conventions .....	9
General safety and hazard warnings for all DEWETRON systems .....	10
Maintenance.....	13
Windows updates and antivirus/security software .....	14
Problematic network stacks .....	14
Environmental Considerations .....	14
Blockdiagram of the internal signal processing .....	15
First steps .....	16
<b>Main System</b>	<b>17</b>
DEWE-2608 - Industrial PC .....	17
System specifications .....	17
DEWE-260x at a glance .....	19
Power supply .....	22
Adding or exchanging PCI boards .....	27
Maintenance.....	30
<b>Software</b>	<b>31</b>
<b>CE-Certificate of conformity</b>	<b>C1</b>

# Table of content

---

## Training

DEWETRON offers training at various offices around the world several times each year. DEWETRON headquarters in Austria have a very large and professional conference and seminar center, where training classes are conducted on a regular basis starting with sensors and signal conditioning, A/D technology and software operation. For more information about training services, please visit:  
<http://www.dewetron.com/support/training>

Dewetron Inc. in the USA also has a dedicated training facility connected to its headquarters, located in Rhode Island. For more information about training services in the US, please visit:  
<http://www.dewamerica.com/support/trainingsclasses>

## Calibration

Every instrument needs to be calibrated at regular intervals. The standard norm across nearly every industry is annual calibration. Before your DEWETRON data acquisition system is delivered, it is calibrated at our DEWETRON headquarter. Each of this system is delivered with a certificate of compliance with our published specifications. Detailed calibration reports from our calibration system are available for purchase with each order. We retain them for at least one year, so calibration reports can be purchased for up to one year after your system was delivered.

## Support

DEWETRON has a team of people ready to assist you if you have any questions or any technical difficulties regarding the system. For any support please contact your local distributor first or DEWETRON directly.

For Asia and Europe, please contact:

DEWETRON Ges.m.b.H.  
Parkring 4  
A-8074 Graz-Grambach  
AUSTRIA  
Tel.: +43 316 3070  
Fax: +43 316 307090  
Email: [support@dewetron.com](mailto:support@dewetron.com)  
Web: <http://www.dewetron.com>

The telephone hotline is available  
Monday to Friday between  
08:00 and 17:00 CET (GMT +1:00)

## Service/repairs

Only the team of DEWETRON is allowed to perform any kinds of repairs to your system to assure a safe and proper operation in future. For information regarding service and repairs please contact your local distributor first or DEWETRON directly.

For the Americas, please contact:

DEWETRON, Inc.  
10 High Street, Suite K  
Wakefield, RI 02879  
U.S.A.  
Tel.: +1 401 284 3750  
Toll-free: +1 877 431 5166  
Fax: +1 401 284 3755  
Email: [support@dewamerica.com](mailto:support@dewamerica.com)  
Web: <http://www.dewamerica.com>

The telephone hotline is available  
Monday to Friday between  
08:00 and 17:00 GST (GMT -5:00)



Any spare parts (screws, backplanes, cables,...) must be obtained from DEWETRON only.

# Notice

---

The information contained in this document is subject to change without notice.

DEWETRON elektronische Messgeraete Ges.m.b.H. (DEWETRON) shall not be liable for any errors contained in this document. DEWETRON MAKES NO WARRANTIES OF ANY KIND WITH REGARD TO THIS DOCUMENT, WHETHER EXPRESS OR IMPLIED. DEWETRON SPECIFICALLY DISCLAIMS THE IMPLIED WARRANTIES OF MERCHANTABILITY AND FITNESS FOR A PARTICULAR PURPOSE. DEWETRON shall not be liable for any direct, indirect, special, incidental, or consequential damages, whether based on contract, tort, or any other legal theory, in connection with the furnishing of this document or the use of the information in this document.

## Warranty Information

A copy of the specific warranty terms applicable to your DEWETRON product and replacement parts can be obtained from your local sales and service office.

## Restricted Rights Legend

Use austrian law for duplication or disclosure.

DEWETRON GesmbH  
Parkring 4  
A-8074 Graz-Grambach / Austria

TRION™ is a trademark of DEWETRON Ges.m.b.H.

SYNC-CLOCK™ is a trademark of DEWETRON Ges.m.b.H.

SUPER-COUNTER™ is a trademark of DEWETRON Ges.m.b.H.

DEWESoft™ is a trademark of DEWESoft d.o.o.

Any other trademarks and registered trademarks are acknowledged to be the property of their owners.

## Printing History

Please refer to the page bottom for printing version.

Copyright © DEWETRON elektronische Messgeraete Ges.m.b.H.

This document contains information which is protected by copyright. All rights are reserved. Reproduction, adaptation, or translation without prior written permission is prohibited, except as allowed under the copyright laws.

# Safety conventions

---

## Safety conventions

---



*Observe precautions for handling electrostatic sensitive devices!*

---



*This icon denotes a caution, which advises you of precautions to take to avoid injury, data loss, or a system crash. When this symbol is marked on the product, refer to the technical reference manual.*

---



*Indicates hazardous voltages.*

---



*Indicates the chassis terminal*

---

**WARNING** *Calls attention to a procedure, practice, or condition that could cause bodily injury or death.*

---

**CAUTION** *Calls attention to a procedure, practice, or condition that could possibly cause damage to equipment or permanent loss of data.*

---

# Safety instructions

---

**Your safety is our primary concern! Please be safe!**



## **General safety and hazard warnings for all DEWETRON systems**

- Use this system under the terms of the specifications only to avoid any possible danger. If the unit is used in a manner not specified by the manufacturer the protection can be impaired!
- This product is intended for use in industrial locations. As a result, this product may cause interference if used in residential areas. Such use must be avoided unless the user takes special measures to reduce electromagnetic emissions to prevent interferences to the reception of radio and television broadcasts.
- Maintenance will be executed by qualified staff only.
- During the use of the system, it might be possible to access another parts of a more comprehensive system. Please read and follow the safety instructions provided in the manuals of all other components regarding warning and security advices for using the system.
- With this product, only use the power cable delivered or defined for the host country.
- DO NOT connect or disconnect sensors, probes or test leads, as these parts are connected to a voltage supply unit.
- The system is grounded via a protective conductor in the power supply cord. To avoid electric shocks, the protective conductor has to be connected with the ground of the power network. Before connecting the input or output connectors of the system, make sure that there is a proper grounding to guarantee potential free usage. For countries, in which there is no proper grounding, please refer to your local legally safety regulations for safety use.

DC systems: Every DC system has a grounding connected to the chassis (yellow/green safety banana plug).

- Please note the characteristics and indicators on the system to avoid fire or electric shocks. Before connecting the system, please carefully read the corresponding specifications in the product manual.
- The inputs are not, unless otherwise noted (CATx identification), for connecting to the main circuits of category II, III and IV. The measurement category can be adjusted depending on module configuration.
- The power cord separates the system from the power supply. Do not block the power cord, since it has to be accessible for the users.
- Supply overvoltage category is II.
- DO NOT use the system if equipment covers or shields are removed.
- If you assume the system is damaged, get it examined by authorised personnel only.
- Any use in wet rooms, outdoors or in adverse environmental condition is not allowed!  
Adverse environmental conditions are:
  - Moisture or high humidity
  - Dust, flammable gases, fumes or dissolver
  - Thunderstorm or thunderstorm conditions (except assembly PNA)
  - Electrostatic fields, et cetera.
- Any direct voltage output is protected with a fuse against short cut and reverse-polarity, but is NOT galvanically isolated (except it is explicit marked on the system).
- The system must be connected and operated to an earthed wall socket at the AC mains power supply only (except for DC systems).
- Any other use than described above may damage your system and is attended with dangers like shortcut, fire or electric shocks.

# Safety instructions

- The whole system must not be changed, rebuilt or opened (except for changing TRION™ modules).
  - If you assume a more riskless use is not provided anymore, the system has to be rendered inoperative and should be protected against inadvertent operation. It is assumed that a more riskless operation is not possible anymore, if
    - the system is damaged obviously or causes strange noises.
    - the system does not work anymore.
    - the system has been exposed to long storage in adverse environmental.
    - the system has been exposed to heavy shipment strain.
  - DO NOT touch any exposed connectors or components if they are live wired. The use of metal bare wires is not allowed. There is a risk of short cut and fire hazard!
  - Warranty void if damages caused by disregarding this manual. For consequential damages NO liability will be assumed!
  - Warranty void if damages to property or persons caused by improper use or disregarding the safety instructions.
  - Unauthorized changing or rebuilding the system is prohibited due to safety and permission reasons (CE). Exception: changing TRION™ modules.
  - The assembly of the system is equivalent to protection class I. For power supply, only the correct power socket of the public power supply must be used, except the system is DC powered.
  - Be careful with voltages  $>25 V_{AC}$  or  $>35 V_{DC}$ ! These voltages are already high enough in order to get a perilous electric shock by touching the wiring.
  - Maximum input voltage for measuring cards are  $70 V_{DC}$  and  $46.7 V_{PEAK}$
  - The product heats during operation. Make sure there is adequate ventilation. Ventilation slots must not covered!
  - Only fuses of the specified type and nominal current may be used. The use of patched fuses is prohibited.
  - Prevent using metal bare wires! Risk of short cut and fire hazard!
  - DO NOT use the system before, during or shortly after a thunderstorm (risk of lightning and high energy overvoltage). An advanced range of application under certain conditions is allowed with therefore designed products only. For details please refer to the specifications.
  - Make sure that your hands, shoes, clothes, the floor, the system or measuring leads, integrated circuits and so on, are dry.
  - DO NOT use the system in rooms with flammable gases, fumes or dust or in adverse environmental conditions.
  - Avoid operation in the immediate vicinity of:
    - high magnetic or electromagnetic fields
    - transmitting antennas or high-frequency generators
- For exact values please refer to enclosed specifications.
- Use measurement leads or measurement accessories aligned to the specification of the system only. Fire hazard in case of overload!
  - Do not switch on the system after transporting it from a cold into a warm room and vice versa. The thereby created condensation may damage your system. Acclimatise the system unpowered to room temperature.
  - Do not disassemble the system! There is a high risk of getting a perilous electric shock. Capacitors still might be charged, even the system has been removed from the power supply.

# Safety instructions

---

- The electrical installations and equipments in industrial facilities must be observed by the security regulations and insurance institutions.
- The use of the measuring system in schools and other training facilities must be observed by skilled personnel.
- The measuring systems are not designed for use at humans and animals.
- Please contact a professional if you have doubts about the method of operation, safety or the connection of the system.
- Please be careful with the product. Shocks, hits and dropping it from already lower level may damage your system. For exact values please refer to enclosed specifications.
- Please also consider the detailed technical reference manual as well as the security advices of the connected systems.

This product has left the factory in safety-related flawless and proper condition.

In order to maintain this condition and guarantee safety use, the user has to consider the security advices and warnings in this manual.

EN 61326-3-1:2008

IEC 61326-1 applies to this part of IEC 61326 but is limited to systems and equipment for industrial applications intended to perform safety functions as defined in IEC 61508 with SIL 1-3.

The electromagnetic environments encompassed by this product family standard are industrial, both indoor and outdoor, as described for industrial locations in IEC 61000-6-2 or defined in 3.7 of IEC 61326-1. Equipment and systems intended for use in other electromagnetic environments, for example, in the process industry or in environments with potentially explosive atmospheres, are excluded from the scope of this product family standard, IEC 61326-3-1.

Devices and systems according to IEC 61508 or IEC 61511 which are considered as “operationally well-tried”, are excluded from the scope of IEC 61326-3-1.

Fire-alarm and safety-alarm systems, intended for protection of buildings, are excluded from the scope of IEC 61326-3-1.



*For safety reasons max. 50 V may be applied to the BNC input-connectors!  
Refer to the regulation of maximum allowable touch potential.*

---

## Maintenance

The information in this section is designed for use by qualified service personal.

### Service interval:

Clean dust from the chassis exterior/interior and exchange filter foam based on the operating environment.

### Cleaning:

Clean surface of the chassis with dry lint-free cloth.

Use a dry velocity stream of air to clean the chassis interior.



- Disconnect all cables before servicing the unit!
- Many components within the chassis are sensitive to static discharge damage. Always wear a ground wrist strap and service the unit only in static-free environment.
- Do not use harsh chemical cleaning agents!

# General information

## CAUTION

- The system BIOS is protected by password. Any change in the BIOS may cause a system crash. When the system is booting, do not press ESC-button on keyboard. This may clear the BIOS settings and cause system faults.
- Any change in the file structure as deleting or adding files or directories might cause a system crash.
- Before installing software updates contact DEWETRON or your local distributor. Use only software packages which are released by DEWETRON. Further informations are also available in the internet (<http://www.dewetron.com>).
- After power off the system wait at least 10 seconds before switching the system on again. Otherwise the system may not boot correct. This prolongs also the life of all system components.

## Windows updates and antivirus/security software

Before installing Windows software updates consult with DEWETRON for compatibility guidance. Please also keep in mind that the use of any antivirus or other security software may slow down your system and may cause data loss.

## Problematic network stacks

Often intrusive IT software or network processes can interfere with the primary function of the DEWETRON system: to record data. Therefore we recommend strongly against the installation of IT/MIS software and running their processes on any DEWETRON data acquisition system, and cannot guarantee the performance of our systems if they are so configured.



## Environmental Considerations

Information about the environmental impact of the product.

## Product End-of-Life Handling

Observe the following guidelines when recycling a DEWETRON system:

## System and Components Recycling

Production of these components required the extraction and use of natural resources. The substances contained in the system could be harmful to your health and to the environment if the system is improperly handled at it's end of life! Please recycle this product in an appropriate way to avoid an unnecessary pollution of the environment and to keep natural resources.

This symbol indicates that this system complies with the European Union's requirements according to Directive 2002/96/EC on waste electrical and electronic equipment (WEEE). Please find further information about recycling on the DEWETRON website [www.dewetron.com](http://www.dewetron.com)

## Restriction of Hazardous Substances

This product has been classified as Monitoring and Control equipment, and is outside the scope of the 2011/65/EU RoHS Directive. This product is known to contain lead.

## Blockdiagram of the internal signal processing

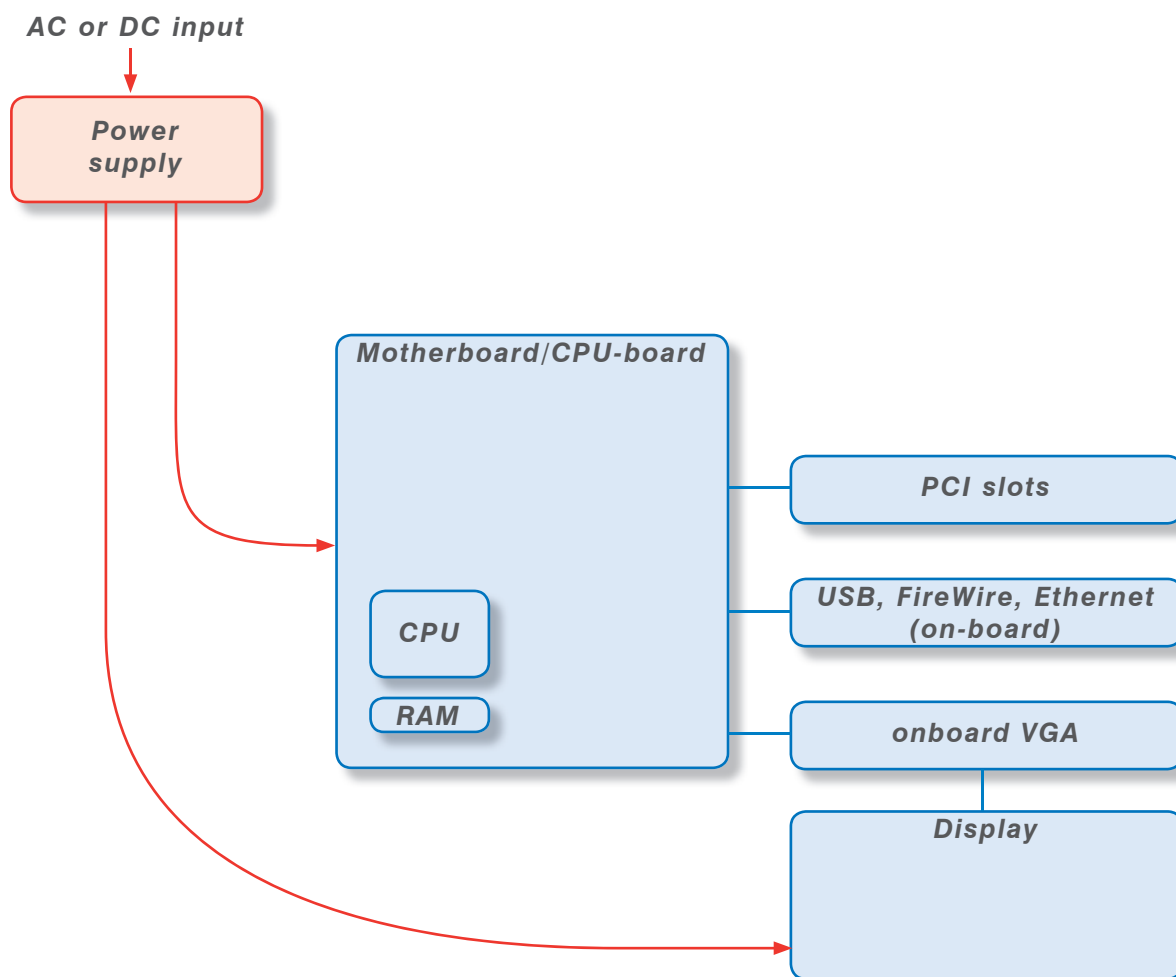

# First steps

---

## First steps

1



Power-on your system.

2

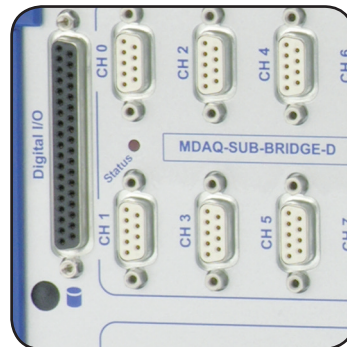

Connect your sensors to the system.

3

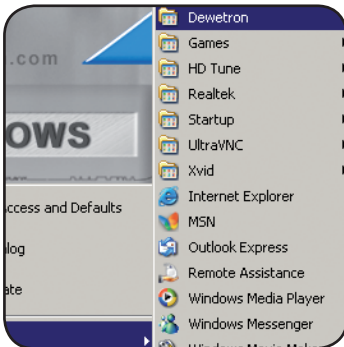

Run DEWESoft usually via "Start" >"Programs" > "Dewetron" > "DEWESoft x.x" > "DEWESoft x.x"

4

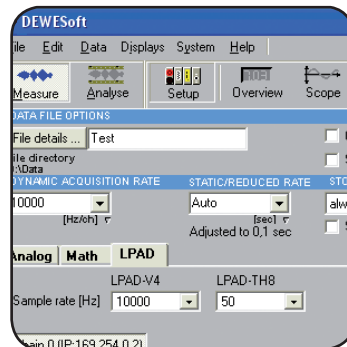

Start recording your data!

All accessories shown in this document are available as option and will not be shipped as standard parts. These parts are described as "option".

## DEWE-2608 - Industrial PC

- Portable industrial PC
- Up to 7 ISA / PCI slots  
(depending on configuration)



## System specifications

DEWE-2608		
Standard power supply:	Rated input voltage 100 to 240 V <sub>AC</sub> input (max. 90 to 264 V <sub>AC</sub> )	Model BEA-640
Power supply options: 2600-POW-BAT	Rated input voltage 8 to 24 V <sub>DC</sub> input (battery powered)	XP-04 with DC-123
Operating temperature:	0 °C to +50 °C	
Operating temperature with 2600-POW-BAT option:	0 °C to +50 °C when discharging batteries 0 °C to +45 °C when charging batteries	
Storage temperature:	-20 °C to +70 °C	
Humidity (operating):	10 % to 80 %, non condensing 5 % to 95 %, rel. humidity	
Vibration test** EN 60068-2-6 (exceeds MIL-STD 810F 514.5 procedure I)	Shape Frequency range Acceleration Sweep rate Duration Test in 3 directions	
Vibration test** EN 60721-3-2 Class 2M2	Shape Frequency range Power spectral density Duration	
Shocktests** EN 60068-2-27 (Exceeds MIL-STD 810F 516.5 procedure I)	Shape Acceleration amplitude Duration Test in 3 axis, 3 shocks in each axis and direction	
Dimensions: (W x D x H):	approx. 409 x 245 x 291 mm (16.1 x 9.6 x 11.5 in.)	
Weight:	typ. 17 kg (37.4 lbs), depending on configuration	
*) depending on system configuration! For details see next pages.		
**) tested with SSD disc		



**Note:** If option 2600-PS-BAT is installed in your system and you don't use it for more than 2 weeks, please remove the batteries and store them separately! Otherwise the batteries will be discharged completely and may be destroyed!

# Main System

## Dimensions\*

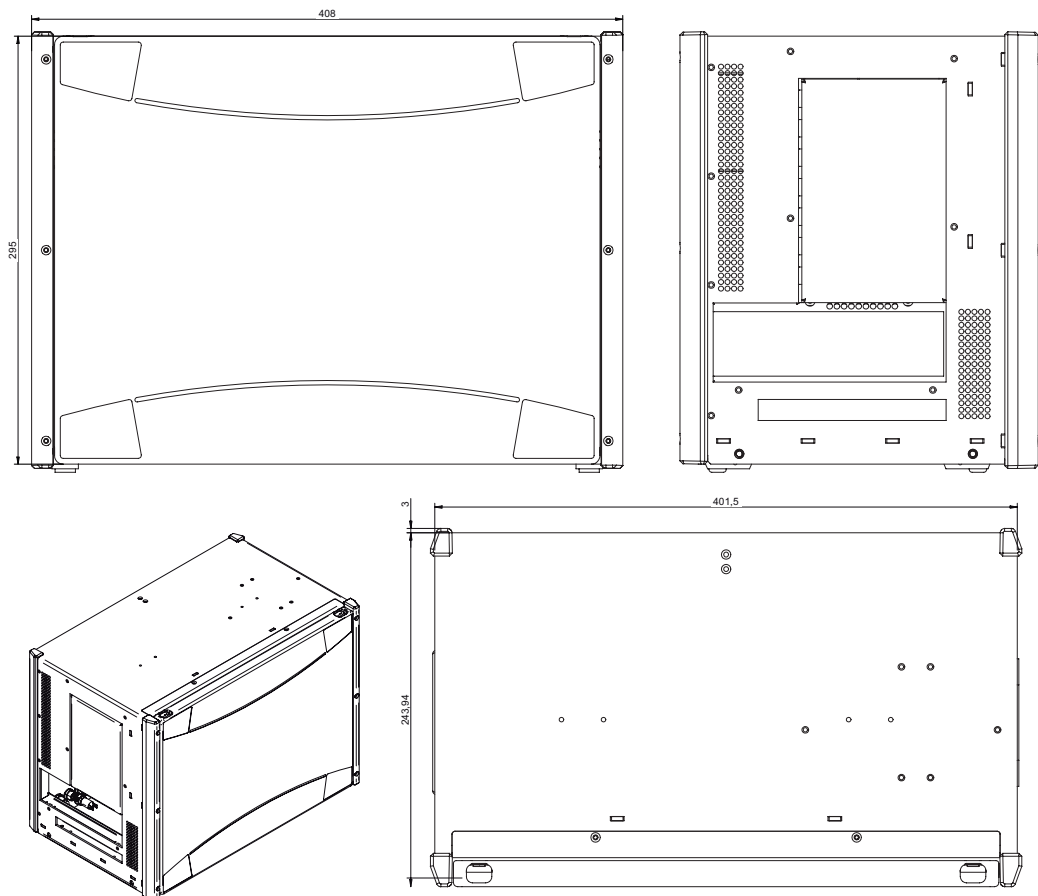

\* Dimensions in mm  
(1 inch = 25.4 mm)

## DEWE-260x at a glance

Typical DEWE-2600 front view

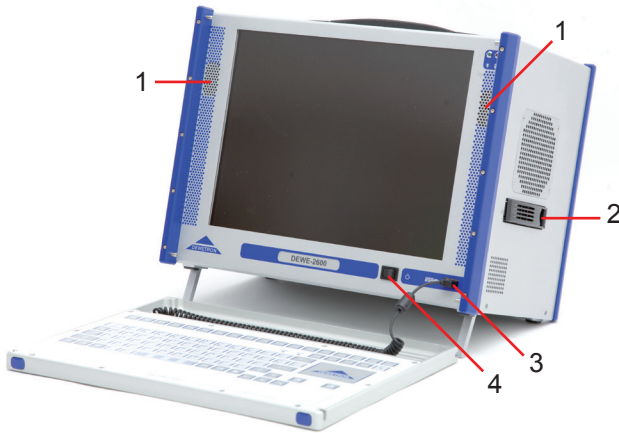

- 1 Built in speakers
- 2 External HDD access
- 3 USB interface connector
- 4 Power-on button
- 5 Ground connector
- 6 **Power supply for accessories**  
(12 V<sub>DC</sub> / 1.5 A)
- 7 **EPAD connector**
- 8 **CAN connector**
- 9 **Power supply input connector**  
(with option 2600-PS-BAT)
- 10 Ethernet LAN connector
- 11 Display Port connector
- 12 DVD multi-drive
- 13 DVI connector
- 14 Audio device  
(LINE IN, MIC, LINE OUT)

Typical DEWE-2608 rear view

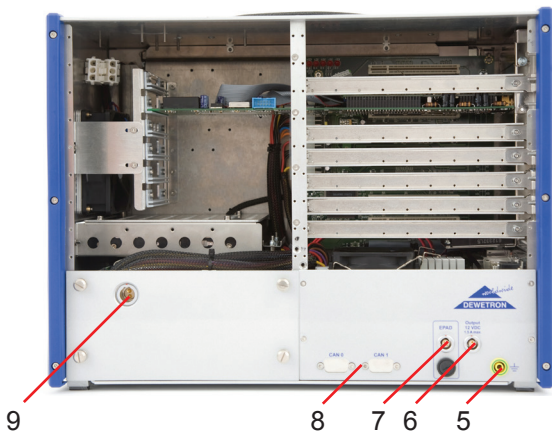

Typical DEWE-2608 side view

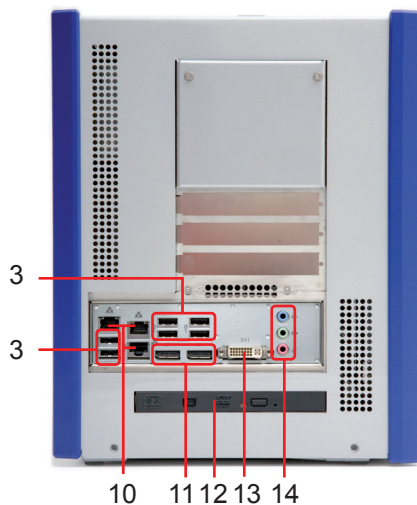

*Note: The location of the connectors might vary from system to system and depends on configuration*

# Main System

---

## 3 USB interface connectors (Universal Serial Bus)

The USB interface connectors meets standard USB pin assignment.

## 4 Power-on button

The power-on push button has to be used to switch on the system. It only works when the main power switch (20) is on.

## 5 Ground connector

For some kind of measurements, it's necessary to give the system an additional ground connection.

## 6 Power supply for accessories

To supply your accessories with 12 V<sub>DC</sub>. Fused with an 1.5 A self-recovering fuse.

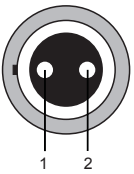

Pin assignment  
1: +12 V, max 1.5 A  
2: GND

*Lemo EGG.1B.302*  
Mating connector:

LEMO FGG.1B.302.CLAD52Z (for cable diameter 4.1 to 5.0 mm)  
LEMO FGG.1B.302.CLAD62Z (for cable diameter 5.1 to 6.0 mm)

## 7 EPAD connector (LEMO)

To connect DEWETRON EPAD modules to the system.

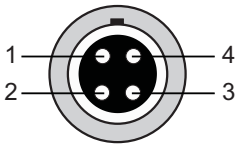

Pin assignment  
1: RS-485 A  
2: RS-485 B  
3: +12 V  
4: GND

*Lemo EGG.1B.304*

Shield is connected on housing

Mating connector:

LEMO FGG.1B.304.CLAD52Z (for cable diameter 4.1 to 5.0 mm)  
LEMO FGG.1B.304.CLAD62Z (for cable diameter 5.1 to 6.0 mm)

## 8 CAN connector (optional)

This connector supports the CAN signals of the built-in A/D board. If this board does not support CAN signals, the connector is not available.

### CAN 0:

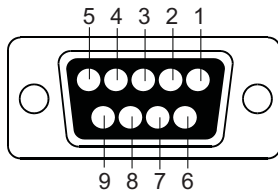

#### Pin assignment

- 1: +5 V
- 2: CAN0\_L
- 3: GND
- 4: n.c.
- 5: n.c.
- 6: GND
- 7: CAN0\_H
- 8: n.c.
- 9: +12 V

### CAN 1:

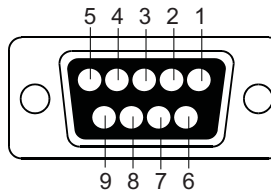

#### Pin assignment

- 1: +5 V
- 2: CAN1\_L
- 3: GND
- 4: n.c.
- 5: n.c.
- 6: GND
- 7: CAN1\_H
- 8: n.c.
- 9: +12 V

## 9 Power supply input connector

For details see chapter power supply.

## 10 Ethernet LAN connector

The DEWE-2608 system supports 10/100/1000 BaseT Ethernet with standard RJ45 connector.

## 11 Display port connector

The Display port connector meets standard display port pin assignment.

## 12 DVD multi-drive

## 13 DVI connector

The DVI connector meets standard VGA pin assignment.

## 14 Audio Device

# Main System

## Power supply

### AC standard power supply

400 W AC power supply BEA-640	
Input:	
Rated input voltage:	100 to 240 V <sub>AC</sub> (max. 90 to 264 V <sub>AC</sub> ); active PFC
Input frequency:	47 to 63 Hz
Max. input current:	7 A (115 V <sub>AC</sub> ), 3.5 A (230 V <sub>AC</sub> )
Output:	
Output power:	max. 400 W
Output voltages:	+3.3 V (max. 28 A) +5 V (max. 35 A)    -5 V (max. 0.5 A) +5 Vsb (max. 2 A) +12 V (max. 30 A)    -12 V (max. 0.8 A)

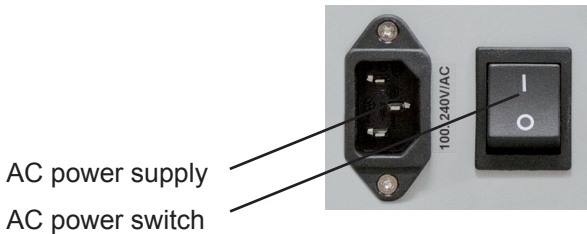

### Internal battery power supply: option DEWE-2600-PS-BAT

320 W DC power supply with XP-04 battery management	
Input:	
Input range:	18 to 24 V <sub>DC</sub> (nom. 18 V <sub>DC</sub> )
Input frequency:	DC
Max. input current:	12 A
External AC power supply:	90 to 260 V <sub>AC</sub> (DEWE-POW-24-350 included as standard accessory)
Output:	
Output power:	320 W with XP-04 battery management (with DCDC-123)
Output voltages:	+3.3 V (max. 10 A) +5 V (max. 10 A) +12 V (max. 12 A)

Power supply pin assignment:



Connector type  
2-pin. male  
LEMO EGJ.2B.302

If option 2600-PS-BAT is installed, there are 3 slots for hot-swappable smart batteries available in the system. Standard shipment includes 2 smart batteries, more can be ordered additionally (option BAT-95WH).

Optional cables:

C7502: LEMO 2B jack to LEMO 2B plug, 2 m. (used for connecting DEWE-2608 to DEWE-POW-24-350 or to DEWE-DCDC-24-350-ISO)

C8502: LEMO 2B jack to banana plugs, 2 m.

**Note:** If the system is powered by batteries, please take care that there are at least 2 batteries installed! In some special applications 3 batteries are necessary! (Hot swap of the batteries not possible)

## External AC/DC power supply (standard accessory included with option 2600-PS-BAT)

AC/DC power supply	DEWE-POW-24-350
Input:	
Rated input voltage:	100 to 240 V <sub>AC</sub> (max. 90 to 264 V <sub>AC</sub> )
Input frequency:	47 to 63 Hz
Input current (typ.):	2 A @ 230 V <sub>AC</sub> / 4 A @ 115 V <sub>AC</sub>
Inrush current (typ.):	44 A @ 230 V <sub>AC</sub> / 22 A @ 115 V <sub>AC</sub>
Leakage current:	<2 mA @ 240 V <sub>AC</sub>
P.F.C. (typ.):	0.95 @ 230 V <sub>AC</sub> / 0.98 @ 115 V <sub>AC</sub>
Output:	
Output voltage:	24 V
Min. load:	0 A
Rated load (free / fan):	12.5 A / 14.6 A
Output tolerance:	±2 %
Ripple & Noise (max.):	150 mV
Efficiency (typ.):	88 %
Output connector:	Banana jacks and LEMO EGG.2B.302
Protection:	
Overload:	105 % to 130 % constant current limiting, auto recovery
Over voltage:	26.7 to 32.4 V; Hiccup mode, auto recovery after fault has been removed
Over temperature:	> 80°C ±5°C detect on heat sink of power transistor Shutdown, auto recovery after temp. has fallen
Short circuit:	Yes
Setup time:	<2000ms @ 230V <sub>AC</sub> / 4000ms @ 115V <sub>AC</sub>
Rise time:	<100ms @ 230 V <sub>AC</sub> / 100ms @ 115 V <sub>AC</sub>
Holdup time:	16ms @ 230 V <sub>AC</sub> / 16ms @ 115 V <sub>AC</sub>
Withstand voltage:	I/P-O/P:3 KV <sub>AC</sub> , I/P-FG:1.5 KV <sub>AC</sub> , O/P-FG:0.5 KV <sub>AC</sub> / 1 minute
Isolation resistance:	I/P-O/P, I/P-FG, O/P-FG: 500 V <sub>DC</sub> / 100 MOhm
Switching frequency:	100 kHz
Temperature:	
Operating:	-10 to 65°C
Derating:	45 to 60°C: 2 %/°C (3.5 & 5 V: 40 to 65°C: 2 %/°C)
Storage:	-40 to 85°C
Humidity:	
Operating:	20 to 90 % RH
Storage:	10 to 95 % RH (non condensing)
M.T.B.F.:	> 106 K hours ( according to MIL-HDBK-217F at 25°C environment)
Safety:	Approved: UL 60950-1 / TÜV EN60950-1
EMC:	
EMI	EN55022 Class B / EN61000-3-2,3
EMS	EN61000-4-2,3,4,5,6,8,11 / ENV50204
Dimensions (W x D x H):	248 x 106 x 62 mm (9.8 x 4.2 x 2.4 in.)
Weight:	1.7 kg (3.7 lbs)

# Main System

---

## DEWE-2608 with option PS-BAT and external AC/DC power supply

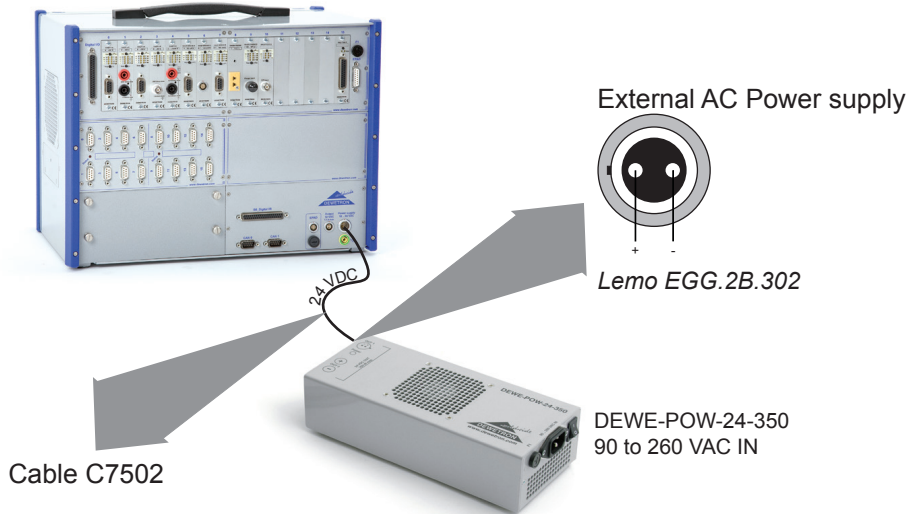

## Smart battery packs



Smart battery packs are equipped with an integrated circuit which stores information (such as manufacturer, serial number, production date etc.) and monitors the current battery status in terms of discharge rate, predicted remaining capacity, temperature, voltage etc. The battery packs, supplied with every battery powered DEWETRON system, are even capable of displaying their charge state without a separate device. With the push of a button, a LED display on the battery pack shows the current charge state in 25% steps. An intelligent battery controller, integrated in our DEWETRON systems, takes care of the charging and discharging process in order to ensure maximum battery performance and life time.

## External battery charger (optional)

External battery charger	CH5000A/E/U
Power supply:	
Input voltage:	90 to 260 VAC, 24V
Input current:	2.5 A
Mains Cord:	CH5000E - 220 V European 2-pin connector with ground recess
Dimensions (WxDxH):	180 mm x 92 mm x 58 mm
Weight:	ca. 250 g
Mating connector:	5-blade standard battery connector

From time to time, due to the aging process of the batteries, it is necessary to recalibrate the battery in order to retain the accuracy and reliability of the fuel gauge. This can be achieved with an external battery charger (BAT-CHARGER) which is optionally available. Another advantage of the BAT-CHARGER is that additional batteries can be recharged without being in the measurement unit. This allows the measurement unit to run non-stop without being connected to the power net, thanks to the hot-swap capability of the battery packs.



# Main System

## External DC/DC power supply (recommended option if system is configured with 2600 PS-BAT power supply)

DC/DC power supply	DEWE-DCDC-24-300-ISO
Input:	
Input voltage:	10 to 36 V <sub>DC</sub> (the input is protected against wrong polarity)
Max. input current:	36 A @ 10 V <sub>DC</sub> input voltage (15 A @ 24 V <sub>DC</sub> )
Input connector:	2-pin LEMO connector male, type: EGJ.2B.302
Output:	
Output voltages:	24 V
Output power:	300 W
Output current:	12.5 A
Output connector:	2-pin LEMO connector female, type: EGG.2B.302
Operating temperature:	-20 °C to 60 °C
Derating above 45 °C:	8 Watt/°C
Isolation voltage:	500 V <sub>DC</sub>
Status LED:	Green LED indicates an output voltage > 21 V <sub>DC</sub>
Dimensions: (W x D x H):	approx. 219 x 122 x 50 mm (8.6 x 4.8 x 2 in.)
Weight:	1.3 kg (2.9 lbs)
Power on sequence: First: Connect the system and the DEWE-DCDC-24-300 followed by the power supply connection.	

As an option the DEWE-2608 is shipped with the DEWE-DCDC-24-300-ISO. This power supply serves galvanic isolated voltage with a wide input range from 10 to 36 V<sub>DC</sub>. The output voltage is fixed with 24 V<sub>DC</sub> with a maximum output power of 300 W.

Depending on the configuration, the DEWE-2608 takes usually not more than 150 W. The typical power consumption is just around 70 W. However, if the batteries are empty the input current can go up to 12 Ampere which is an equivalent power consumption of 280 Watt! If the unit is supplied from a typical board supply of 12 V it needs an input current of 28 A!

If this high power is not available in the board supply please operate the DEWE-2608 without or with charged batteries.

### Dimensions\*

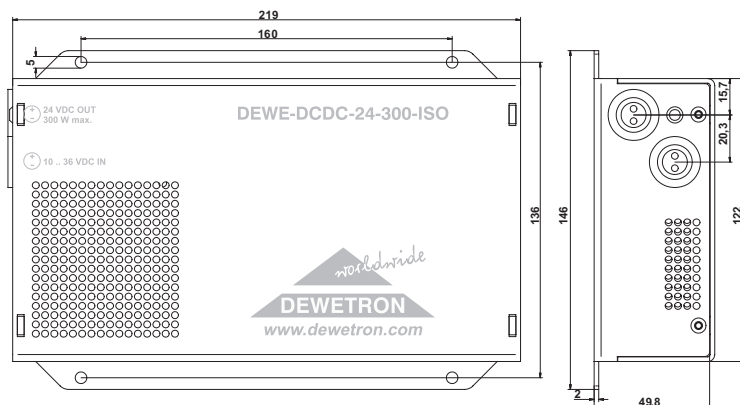

\* Dimensions in mm  
(1 inch = 25.4 mm)

### Input connector



Pin assignment  
1: 10 .. 36 V<sub>DC</sub> input  
2: GND

Lemo EGJ.2B.302

### Output connector



Pin assignment  
1: 24 V<sub>DC</sub> output  
2: GND

Lemo EGG.2B.302

Optional cables: C8502 LEMO 2B jack to banana plugs, 2 m.

## Adding or exchanging PCI boards

### Installing half-size PCI boards

#### Step 1:



Remove the back panel, now you can see the card fixing bars for each of the PCI slots.

Card fixing bars

Figure 1

#### Step 2:



Remove one card fixing bar per PCI card you plan to install. Loosen the screw nut for the length adjustment of the bar as shown in figure 2.

Then remove 2 screws on the left side and one screw nut on the right side to allow removal of the card fixing bar. Finally remove the bar and after that remove the slot cover.

Figure 2

#### Step 3:

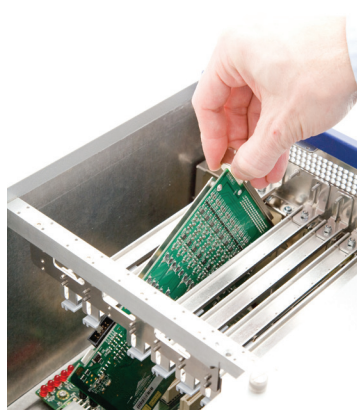

Now insert the half-length PCI card. You need to insert it at an angle as shown in figure 3. Fix the cards slot cover with one screw.

Figure 3

# Main System

---

## Step 4:



Figure 4

Check if the longitudinal PCB guide does not collide with any components on your PCI card. This guide supports the cards in case of shocks or vibrations.

If needed move the small guide to a different place to avoid any collision with components. The plastic guide is fixed by 2 screws and there is a row of threads available for adjustment. If no possible place can be found completely remove the plastic guide.

## Step 5:

Re-install the card fixing bar. Make sure the plastic pcb guide is properly fitted to the card and then fix the whole bar by the 2 screws on the left side and one screw nut on the right side. Finally seize the screw nut for the length adjustment of the bar (see figure 2).

Now re-install the back panel and you are done.

Ensure perfect fit.  
Double-check for  
no collision with  
any components

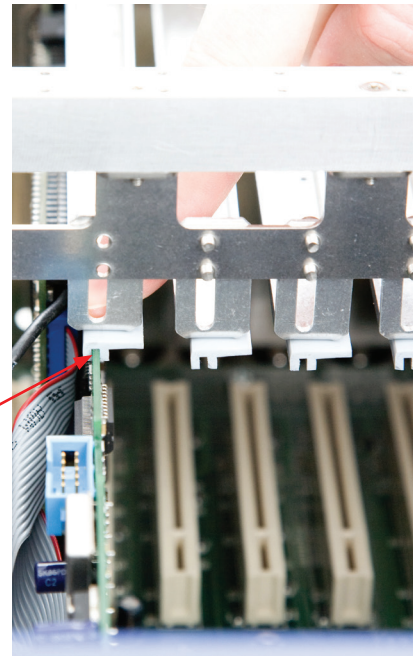

Figure 5

## Installing full-size PCI boards

### Step 1:

Remove the back panel, now you can see the card fixing bars for each of the PCI slots (see figure 1).

### Step 2:



Figure 6

Remove all card fixing bars. Loosen the screw nut for the length adjustment of the bar as shown in picture 2. Remove 2 screws on the left side and one screw nut on the right side of each bar to allow removal.

Also remove the vertical mounting support, 2 screws on the top of the unit and another 2 screws on the backside to divide the support (see figure 6).

Now remove one or more slot covers from the slots you plan to install cards.

### Step 3:

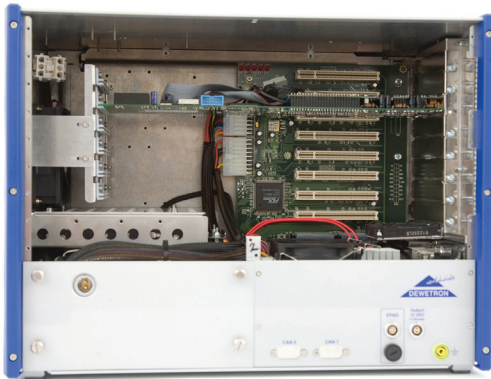

Figure 7

Now insert the PCI card(s).

Don't forget to fix each cards slot cover with one screw.

### Step 4:

Check if the longitudinal PCB guide does not collide with any components on your PCI card. This guide supports the cards in case of shocks or vibrations. See figure 4.

If needed move the small guide to a different place to avoid any collision with components. The plastic guide is fixed by 2 screws and there is a row of threads available for adjustment. If no possible place can be found completely remove the plastic guide.

# Main System

---

## Step 5:



Figure 8

Re-install the vertical mounting support and the card fixing bars. Make sure the plastic pcb guide is properly fitted to each card and then fix each bar by the 2 screws on the left side and one screw nut on the right side. Finally seize the screw nut for the length adjustment of the bar (see figure 2).

## Maintenance

### External HDD access for easy service



If the system harddisk drive gets damaged, an external HDD access for easy service is available. Pull out the access bay for removing/changing the system harddisk drive.

# DEWESoft™

## DEWESoft™ Software Turns our Hardware into a Powerful Data Acquisition System

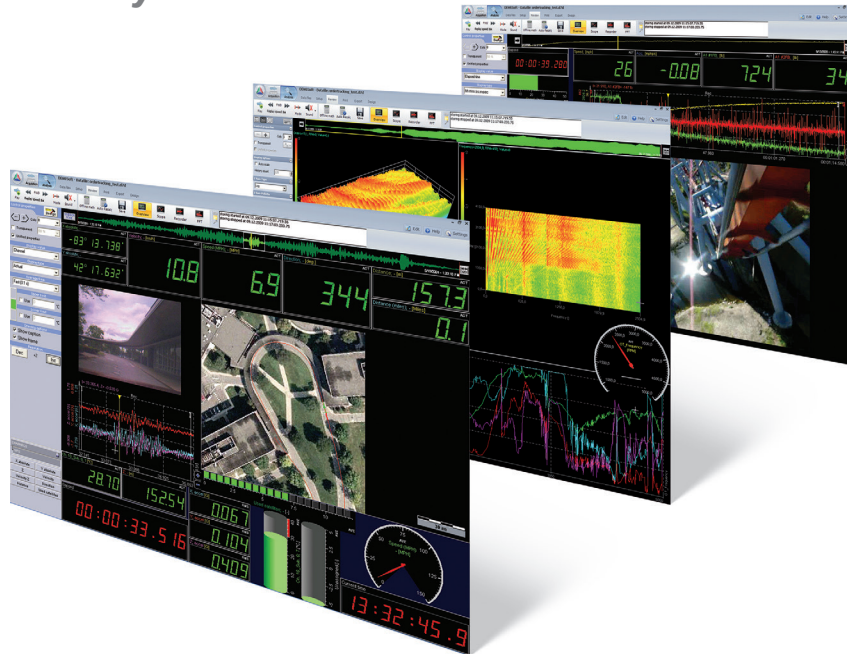

Our award-winning data acquisition package is second to none when it comes to both pure recording power and ease of use. Normally it is a difficult balancing act to provide lots of capability and performance, without making the user interface cumbersome and hard to learn. But with careful and innovative design, we have done exactly that!

The software can act as a simple multi-meter or recorder as well as a sophisticated combustion analyzer or power analyzer. Or anything in between these extremes, like a FFT analyzer, transient recorder, etc.

Over 10 years DEWESoft™ evolved into a great data acquisition software and is Nr.1 in synchronous acquisition of vastly different signals like analog, digital, CAN, GPS, PCM, counter, video, etc. In 2010 with the release of version 7, DEWESoft™ takes a big step toward become a very powerful data analysis tool for a wide range of test & measurement applications. Since many years you can utilize math channels in the measure mode for online calculations. Starting with version 7.0, captured data can be re-calculated in the analyze mode using the large suite of calculation (math) functions available in the measure mode. This eliminates the CPU performance limitations and thus provides unlimited offline calculation power.

Example: Performing a 10<sup>th</sup> order notch filter on 128 channels being sampled at 200 kS/s each. This is not possible online. But in analyze mode it's easy. Simply record the data and then filter it afterwards (math functions are non-destructive, i.e., they do not affect the raw channels).

Another important new feature is the sequencer which provides a way to automate test procedures.

### Key Features of DEWETRON systems running DEWESoft™

- Fast and easy setup
- Perfect sync of vastly different signals like analog, digital, counter, CAN, XCP, GPS, Video, ARINC, 1553, etc.
- Powerful online data processing, MATH functions, filters, statistics, reference curves
- Attractive online display of all kind of data, creation of displays is a matter of seconds
- Analog, digital or CAN data output; powerful function generator, alarms, CAN messages
- Build test procedures in a form of workflow diagram by means of sequencer
- Fast data analysis, reload GByte files in seconds
- Post processing, large suite of calculation (math) functions

## Hardware Support

DEWESoft™ supports DEWETRON hardware cards as well as some third-party cards, like Spectrum cards for transient recording. Multiple cards of the same family are supported for high channel counts.

There is also a huge range of DEWETRON signal conditioners which are all perfectly implemented into the software.

Besides the analog inputs DEWESoft™ supports the digital I/Os, counters and CAN interfaces of DEWETRON hardware.

To acquire video streams in sync with the analog data there is a selection of DEWE-CAM cameras.

Further bus systems like PCM telemetry, XCP, ARINC, 1553, etc. are supported, too. DEWETRON offers the appropriate hardware for all of these.

For position and speed measurements there is a choice of high performance DEWE-VGPS sensors. Or use low-cost sensor which is NMEA compatible for simple position plotting and mapping applications.



DAQx modules

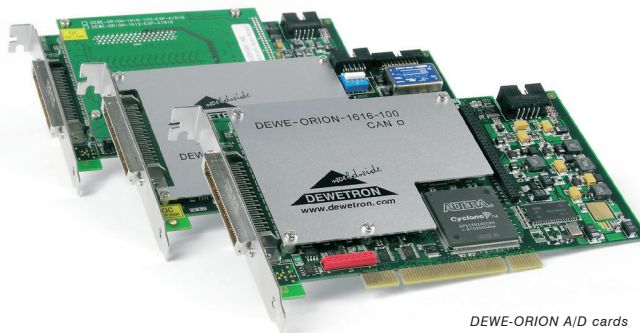

DEWE-ORION A/D cards

## Sensor Database and TEDS (Technical Electronic Data Sheet)

The DEWESoft™ data acquisition software suite was developed especially for measurement technicians, thus simple sensor “connection” is a major topic. Basic settings like sensor setup are easily done. TEDS technology of newer sensors is supported on both the hardware and software side, so that all settings follow automatically, preventing user errors and saving a huge amount of time. For sensors without TEDS, there are numerous options for manual scaling as well as an integrated sensor database to make settings as efficient as possible.

#	Group	Sensor type	Serial number	Scale type	Transfer curve	Recal. date
1	Current	B0133	A_En_R01226-X	Polynom	Yes	01.04.2011
2	Current	B0133	A_En_R01226-Y	Polynom	Yes	01.04.2011
3	Current	B0133	A_En_R01226-Z	Polynom	Yes	01.04.2011
4	Beschl_Enitan	B0132	A_En_R01229-X	Linear	No	21.05.2011
5	Wegaul. Megaton	M101	328947	Linear	No	14.09.2010
6	Beschl_FGP	FGP	254.758	Linear	No	22.11.2010
7	Beschl_FGP	FGP	254.759	Linear	No	22.11.2010
8	Beschl_Enitan	B0131	A_En_R01233-Y	Linear	No	01.01.2020
9	Beschl_Enitan	B0131	A_En_R01233-Z	Linear	No	01.01.2020
10	Beschl_Enitan	B0360	A_En_W98318-X	Linear	No	01.01.2020
11	Beschl_Enitan	B0360	A_En_W98318-Y	Linear	No	01.01.2020

## Video Recording

A camera is a perfect sensor for many applications and a lot of people like to use it in their data acquisition. Video is a useful test documentation, providing a visual record of the test conditions and setup. I can also be used for more in-depth analysis, as you can imagine. There is nothing quite like seeing your data replayed with synchronized video – this DEWETRON innovation provides a whole new level of context and understanding of your test data than you could ever imagine.



## 3D Graph

In the properties panel there is a function that allows you to edit the properties of the selected display, and to create new displays, and rearrange them. You can rename any display, and select a different icon for it. Of course you can add sub-displays to any main display.

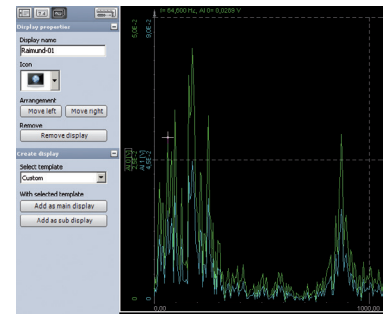

## Display Screens

One of the most powerful and yet easy to use aspect of DEWESoft™ is the creation of displays. Of course a few standard displays like Recorders, Oscilloscope, FFT, Meters, Bars, 2D and 3D graphs, etc. are built-in for you. But this is only the beginning. You simply can create custom displays according to the needs of specific test.

## Project Setup

The project files setup the measurement instruments in seconds including complete hardware setup, measurement configuration, and sensor calibration.

Since DEWESoft version 7 you can create “Projects” at the hardware setup screen level, where each project contains all of the settings for any hardware that you own. You can have an unlimited number of hardware setups, which you can freely name and edit. When you start DEWESoft 7, it will automatically load the last hardware setup that you used, of course ... but if you have changed the hardware, you can simply choose a different project from the “Settings” menu, and a completely different hardware setup will be loaded.

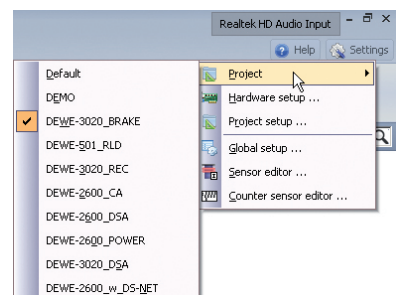

Even when using the same hardware, projects allows using different folders

for setup, data and exported files. So you can create John and George projects for different users and work without interfering or you can create e.g. Road-Load and DSA projects for different tasks.

## Recording

You can control recording as simple as pressing the START, STORE and STOP buttons. But there are also versatile trigger options to e.g. only store data if a trigger event occurs or to store at a slow rate usually but store at a fast rate at a trigger event with definable pre- and post times.

There is a large suite of calculation (math) functions which can be applied to any channels.

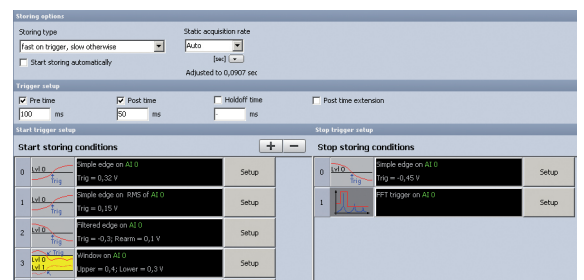

## Analyze – Replay, Re-calculate, Export

In Analyze mode you can replay any captured data file, zoom in, make cursor measurements, print reports and export the data to a wide variety of formats, like Flexpro, Excel, Matlab, Diadem and many more.

Since version 7 all the powerful math functions such as math formulas, filtering, statistics, power analysis, frequency response function, order tracking, torsional vibration, engine combustion analysis, sound analysis, human vibration analysis, and others can also be applied off-line to captured data. So you can simply store the raw data and do all the processing off-line, on any computer, anywhere. This allows you to work with the data as you were at the test bench or on the proving ground.

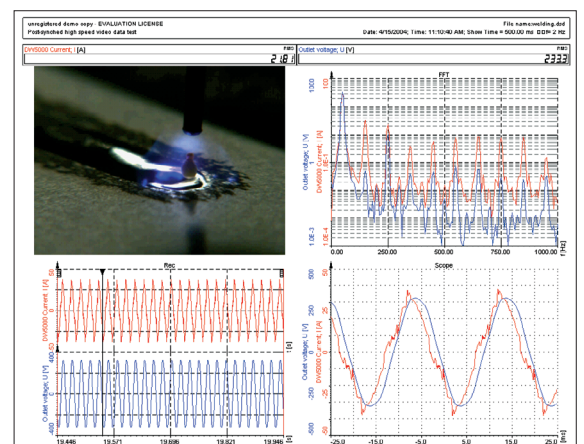

## Notes

# CE-Certificate of conformity



Manufacturer:

**DEWETRON Elektronische Messgeraete Ges.m.b.H.**

Address:

**Parkring 4  
A-8074 Graz-Grambach Austria**

Tel.: +43 316 3070 0

Fax: +43 316 3070 90

e-mail: sales@dewetron.com

http://www.dewetron.com

Name of product:

**DEWE-2608**

Kind of product:

*Industrial PC*

The product meets the regulations of the following EC-directives:

**73/23/EEC**

**"Directive on the approximation of the laws of the Member States relating to electrical equipment designed for use within certain voltage limits amended by the directive 93/68/EEC"**

**89/336/EEC**

**"Directive on the approximation of the laws of the Member States relating to electromagnetic compatibility amended by the directives 91/263/EEC, 92/31/EEC, 93/68/EEC and 93/97/EEC"**

The accordance is proved by the observance of the following standards:

<b>L V E M C</b>	<b>Safety</b>	IEC/EN 61010-1:1992/93 IEC/EN 61010-2-031	IEC 61010-1:1992/300 V CATIII PoI. D. 2 IEC 1010-2-031
	<b>Emissions</b>	EN 61000-6-4	EN 55011 Class B
	<b>Immunity</b>	EN 61000-6-2	Group standard

**Graz, April 28, 2010**

Place / Date of the CE-marking

Dipl.-Ing. Roland Jeutter / Managing director

# Notes

---