

DEWE2-M13

TECHNICAL REFERENCE MANUAL

WELCOME TO THE WORLD OF DEWETRON!

Congratulations on your new device! It will supply you with accurate, complete and reproducible measurement results for your decision making.
Look forward to the easy handling and the flexible and modular use of your DEWETRON product and draw upon more than 25 years of DEWETRON expertise in measurement engineering.

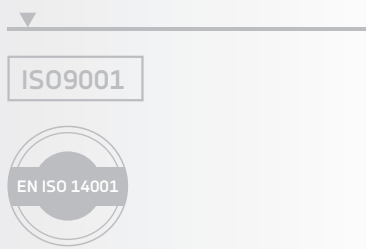

CUSTOMIZED



MODULAR



COMPETENT



COMMITTED



APPROVED

Copyright © DEWETRON GmbH

This document contains information which is protected by copyright. All rights are reserved. Reproduction, adaptation, or translation without prior written permission is prohibited, except as allowed under the copyright laws.

All trademarks and registered trademarks are acknowledged to be the property of their owners.
DEWESoft™ is a trademark of Dewesoft d.o.o

Thank you!

Thank you very much for your investment in DEWETRON's unique data acquisition systems. These are top-quality instruments which are designed to provide you years of reliable service. This guide has been prepared to help you get the most from your investment, starting from the day you take it out of the box, and extending for years into the future.

This guide includes important startup notes, as well as safety notes and information about keeping your DEWETRON system in good working condition over time.

We strongly suggest that you read this entire manual, especially the safety and care sections, as well as to avoid damaging your DEWETRON system.

What is the DEWE2-M13?

This product is used for measuring of different physical and/or electrical sizes (depending on model or configuration). The connection is depending on model or configuration and is done via safety banana plugs, BNC connectors, D-SUB connectors, SMB connectors, μ dot connectors, LEMO® connectors or RJ-45 connectors.

Preface

Notes

Content

General Information, Safety Instructions	7
Training	7
Calibration.....	7
Support	7
Service/repairs	7
Warranty Information	8
Printing History.....	8
Safety conventions	9
General safety and hazard warnings for all DEWETRON systems	10
Maintenance.....	13
Windows updates and antivirus/security software	14
Problematic network stacks	14
Environmental Considerations	14
Blockdiagram of the internal signal processing	15
First steps	16
Main System	17
DEWE2-M13 portable data acquisition mainframe	17
System specifications	17
DEWE2-M13 at a glance	18
TRION™ series modules overview	20
Installing a TRION™ module in the chassis	21
Power supply	22
Maintenance.....	23
System recovery	23
Synchronization of DEWE2	25
Synchronization of multiple DEWE2 devices	25
1.0 Installation of DEWESoft and TRION™ hardware drivers	25
1.2 DEWESoft hardware settings	29
2.0 Overview of DEWE2 chassis	30
2.1 Definition of a Standalone unit	31
2.2 Definition of a Main system	32
2.3 Definition of SyncIn/Out & AUX	33
2.4 Synchronization options in DEWESoft™ (part I)	34
2.5 Channel expansion (up to 7 meters cable length)	35

Table of content

2.6 Sync with option „NET“ (up to 1000 meters cable length)	37
2.7 Defining a Master / Slave unit.....	40
2.8 Synchronization of DEWE2 devices with ORION-DAQ series boards.....	42
2.9 Synchronization options in DEWESoft™ (part II)	43
CE-Certificate of conformity	C1

Training

DEWETRON offers training at various offices around the world several times each year. DEWETRON headquarters in Austria have a very large and professional conference and seminar center, where training classes are conducted on a regular basis starting with sensors and signal conditioning, A/D technology and software operation. For more information about training services, please visit:
<http://www.dewetron.com/services/dewetron-academy/>

Dewetron Inc. in the USA also has a dedicated training facility connected to its headquarters, located in Rhode Island. For more information about training services in the US, please visit:
<http://www.dewetron.us/service-support/system-training-usa/>

Calibration

Every instrument needs to be calibrated at regular intervals. The standard norm across nearly every industry is annual calibration. Before your DEWETRON data acquisition system is delivered, it is calibrated at our DEWETRON headquarter. Each of this system is delivered with a certificate of compliance with our published specifications. Detailed calibration reports from our calibration system are available for purchase with each order. We retain them for at least one year, so calibration reports can be purchased for up to one year after your system was delivered.

Support

DEWETRON has a team of people ready to assist you if you have any questions or any technical difficulties regarding the system. For any support please contact your local distributor first or DEWETRON directly.

For Asia and Europe, please contact:

DEWETRON GmbH
Parkring 4
8074 Grambach
AUSTRIA
Tel.: +43 316 3070
Fax: +43 316 307090
Email: support@dewetron.com
Web: <http://www.dewetron.com>

The telephone hotline is available
Monday to Friday between
08:00 and 17:00 CET (GMT +1:00)

For the Americas, please contact:

DEWETRON, Inc. (HQ USA)
2850 South County Trail, Unit 1
East Greenwich, RI 02818
U.S.A.
Tel.: +1 401 284 3750
Toll-free: +1 866 598 3393
Fax: +1 401 284 3755
Email: us.support@dewetron.com
Web: <http://www.dewetron.us>

The telephone hotline is available
Monday to Friday between
08:00 and 4:30 EST

Service/repairs

Only the team of DEWETRON is allowed to perform any kinds of repairs to your system to assure a safe and proper operation in future. For information regarding service and repairs please contact your local distributor first or DEWETRON directly.



Any spare parts (screws, backplanes, cables,...) must be obtained from DEWETRON only.

Notice

The information contained in this document is subject to change without notice.

DEWETRON GmbH (DEWETRON) shall not be liable for any errors contained in this document. DEWETRON MAKES NO WARRANTIES OF ANY KIND WITH REGARD TO THIS DOCUMENT, WHETHER EXPRESS OR IMPLIED. DEWETRON SPECIFICALLY DISCLAIMS THE IMPLIED WARRANTIES OF MERCHANTABILITY AND FITNESS FOR A PARTICULAR PURPOSE. DEWETRON shall not be liable for any direct, indirect, special, incidental, or consequential damages, whether based on contract, tort, or any other legal theory, in connection with the furnishing of this document or the use of the information in this document.

Warranty Information

A copy of the specific warranty terms applicable to your DEWETRON product and replacement parts can be obtained from your local sales and service office.

Restricted Rights Legend

Use austrian law for duplication or disclosure.

DEWETRON GmbH
Parkring 4
8074 Grambach / Austria

TRION™ is a trademark of DEWETRON GmbH.

DEWESoft™ is a trademark of DEWESoft d.o.o.

Any other trademarks and registered trademarks are acknowledged to be the property of their owners.

Printing History

Please refer to the page bottom for printing version.

Copyright © DEWETRON GmbH

This document contains information which is protected by copyright. All rights are reserved. Reproduction, adaptation, or translation without prior written permission is prohibited, except as allowed under the copyright laws.

Safety conventions

Safety conventions



Observe precautions for handling electrostatic sensitive devices!



This icon denotes a caution, which advises you of precautions to take to avoid injury, data loss, or a system crash. When this symbol is marked on the product, refer to the technical reference manual.



Indicates hazardous voltages.



Indicates the chassis terminal

WARNING *Calls attention to a procedure, practice, or condition that could cause bodily injury or death.*

CAUTION *Calls attention to a procedure, practice, or condition that could possibly cause damage to equipment or permanent loss of data.*

WARNINGS

The following general safety precautions must be observed during all phases of operation, service, and repair of this product. Failure to comply with these precautions or with specific warnings elsewhere in this manual violates safety standards of design, manufacture, and intended use of the product. DEWETRON Elektronische Messgeraete Ges.m.b.H. assumes no liability for the customer's failure to comply with these requirements.

Safety instructions

Your safety is our primary concern! Please be safe!



General safety and hazard warnings for all DEWETRON systems

- Use this system under the terms of the specifications only to avoid any possible danger. If the unit is used in a manner not specified by the manufacturer the protection can be impaired!
- This product is intended for use in industrial locations. As a result, this product may cause interference if used in residential areas. Such use must be avoided unless the user takes special measures to reduce electromagnetic emissions to prevent interferences to the reception of radio and television broadcasts.
- Maintenance will be executed by qualified staff only.
- During the use of the system, it might be possible to access another parts of a more comprehensive system. Please read and follow the safety instructions provided in the manuals of all other components regarding warning and security advices for using the system.
- With this product, only use the power cable delivered or defined for the host country.
- DO NOT connect or disconnect sensors, probes or test leads, as these parts are connected to a voltage supply unit.
- The system is grounded via a protective conductor in the power supply cord. To avoid electric shocks, the protective conductor has to be connected with the ground of the power network. Before connecting the input or output connectors of the system, make sure that there is a proper grounding to guarantee potential free usage. For countries, in which there is no proper grounding, please refer to your local legally safety regulations for safety use.

DC systems: Every DC system has a grounding connected to the chassis (yellow/green safety banana plug).

- Please note the characteristics and indicators on the system to avoid fire or electric shocks. Before connecting the system, please carefully read the corresponding specifications in the product manual.
- The inputs are not, unless otherwise noted (CATx identification), for connecting to the main circuits of category II, III and IV. The measurement category can be adjusted depending on module configuration.
- The power cord or the main power switch separates the system from the power supply. Do not block the power cord or main switch, since it has to be accessible for the users.
- Supply overvoltage category is II.
- DO NOT use the system if equipment covers or shields are removed.
- If you assume the system is damaged, get it examined by authorised personnel only.
- Any use in wet rooms, outdoors or in adverse environmental condition is not allowed!
Adverse environmental conditions are:
 - Moisture or high humidity
 - Dust, flammable gases, fumes or dissolver
 - Thunderstorm or thunderstorm conditions (except assembly PNA)
 - Electrostatic fields, et cetera.
- Any direct voltage output is protected with a fuse against short cut and reverse-polarity, but is NOT galvanically isolated (except it is explicit marked on the system).
- The system must be connected and operated to an earthed wall socket at the AC mains power supply only (except for DC systems).
- Any other use than described above may damage your system and is attended with dangers like shortcut, fire or electric shocks.
- The whole system must not be changed, rebuilt or opened (except for changing TRION™ modules).

Safety instructions

- Reinstall filler panels of unused TRION™ slots to guarantee proper cooling of the installed modules. Warranty void if the modules overheat due to missing filler panels.
 - If you assume a more riskless use is not provided anymore, the system has to be rendered inoperative and should be protected against inadvertent operation. It is assumed that a more riskless operation is not possible anymore, if
 - the system is damaged obviously or causes strange noises.
 - the system does not work anymore.
 - the system has been exposed to long storage in adverse environmental.
 - the system has been exposed to heavy shipment strain.
 - DO NOT touch any exposed connectors or components if they are live wired. The use of metal bare wires is not allowed. There is a risk of short cut and fire hazard!
 - Warranty void if damages caused by disregarding this manual. For consequential damages NO liability will be assumed!
 - Warranty void if damages to property or persons caused by improper use or disregarding the safety instructions.
 - Unauthorized changing or rebuilding the system is prohibited due to safety and permission reasons (CE). Exception: changing TRION™ modules.
 - The assembly of the system is equivalent to protection class I. For power supply, only the correct power socket of the public power supply must be used, except the system is DC powered.
 - Be careful with voltages $>25 V_{AC}$ or $>35 V_{DC}$! These voltages are already high enough in order to get a perilous electric shock by touching the wiring.
 - Maximum input voltage for measuring cards are $70 V_{DC}$ and $46.7 V_{PEAK}$
 - The product heats during operation. Make sure there is adequate ventilation. Ventilation slots must not covered!
 - Only fuses of the specified type and nominal current may be used. The use of patched fuses is prohibited.
 - Prevent using metal bare wires! Risk of short cut and fire hazard!
 - DO NOT use the system before, during or shortly after a thunderstorm (risk of lightning and high energy overvoltage). An advanced range of application under certain conditions is allowed with therefore designed products only. For details please refer to the specifications.
 - Make sure that your hands, shoes, clothes, the floor, the system or measuring leads, integrated circuits and so on, are dry.
 - DO NOT use the system in rooms with flammable gases, fumes or dust or in adverse environmental conditions.
 - Avoid operation in the immediate vicinity of:
 - high magnetic or electromagnetic fields
 - transmitting antennas or high-frequency generators
- For exact values please refer to enclosed specifications.
- Use measurement leads or measurement accessories aligned to the specification of the system only. Fire hazard in case of overload!
 - Do not switch on the system after transporting it from a cold into a warm room and vice versa. The thereby created condensation may damage your system. Acclimatise the system unpowered to room temperature.
 - Do not disassemble the system! There is a high risk of getting a perilous electric shock. Capacitors still might be charged, even the system has been removed from the power supply.

Safety instructions

- Direct exposure of any DEWETRON product to strong sunlight or other heat radiation shall be prevented, as this could excessively heat up the product and lead to permanent damage of the product.
- The electrical installations and equipments in industrial facilities must be observed by the security regulations and insurance institutions.
- The use of the measuring system in schools and other training facilities must be observed by skilled personnel.
- The measuring systems are not designed for use at humans and animals.
- Please contact a professional if you have doubts about the method of operation, safety or the connection of the system.
- Please be careful with the product. Shocks, hits and dropping it from already lower level may damage your system. For exact values please refer to enclosed specifications.
- Please also consider the detailed technical reference manual as well as the security advices of the connected systems.

This product has left the factory in safety-related flawless and proper condition.

In order to maintain this condition and guarantee safety use, the user has to consider the security advices and warnings in this manual.

EN 61326-3-1:2008

IEC 61326-1 applies to this part of IEC 61326 but is limited to systems and equipment for industrial applications intended to perform safety functions as defined in IEC 61508 with SIL 1-3.

The electromagnetic environments encompassed by this product family standard are industrial, both indoor and outdoor, as described for industrial locations in IEC 61000-6-2 or defined in 3.7 of IEC 61326-1. Equipment and systems intended for use in other electromagnetic environments, for example, in the process industry or in environments with potentially explosive atmospheres, are excluded from the scope of this product family standard, IEC 61326-3-1.

Devices and systems according to IEC 61508 or IEC 61511 which are considered as “operationally well-tried”, are excluded from the scope of IEC 61326-3-1.

Fire-alarm and safety-alarm systems, intended for protection of buildings, are excluded from the scope of IEC 61326-3-1.



*For safety reasons max. 50 V may be applied to the BNC input-connectors!
Refer to the regulation of maximum allowable touch potential.*

Maintenance

The information in this section is designed for use by qualified service personal.

Service interval:

Clean dust from the chassis exterior/interior and exchange filter foam based on the operating environment.

Cleaning:

Clean surface of the chassis with dry lint-free cloth.

Use a dry velocity stream of air to clean the chassis interior.



- Disconnect all cables before servicing the unit!
- Many components within the chassis are sensitive to static discharge damage. Always wear a ground wrist strap and service the unit only in static-free environment.
- Do not use harsh chemical cleaning agents!

General information

CAUTION

- The system BIOS is protected by password. Any change in the BIOS may cause a system crash. When the system is booting, do not press ESC-button on keyboard. This may clear the BIOS settings and cause system faults.
- Any change in the file structure as deleting or adding files or directories might cause a system crash.
- Before installing software updates contact DEWETRON or your local distributor. Use only software packages which are released by DEWETRON. Further informations are also available in the internet (<http://www.dewetron.com>).
- After power off the system wait at least 10 seconds before switching the system on again. Otherwise the system may not boot correct. This prolongs also the life of all system components.

Windows updates and antivirus/security software

Before installing Windows software updates consult with DEWETRON for compatibility guidance. Please also keep in mind that the use of any antivirus or other security software may slow down your system and may cause data loss.

Problematic network stacks

Often intrusive IT software or network processes can interfere with the primary function of the DEWETRON system: to record data. Therefore we recommend strongly against the installation of IT/MIS software and running their processes on any DEWETRON data acquisition system, and cannot guarantee the performance of our systems if they are so configured.



Environmental Considerations

Information about the environmental impact of the product.

Product End-of-Life Handling

Observe the following guidelines when recycling a DEWETRON system:

System and Components Recycling

Production of these components required the extraction and use of natural resources. The substances contained in the system could be harmful to your health and to the environment if the system is improperly handled at it's end of life! Please recycle this product in an appropriate way to avoid an unnecessary pollution of the environment and to keep natural resources.

This symbol indicates that this system complies with the European Union's requirements according to Directive 2002/96/EC on waste electrical and electronic equipment (WEEE). Please find further information about recycling on the DEWETRON website www.dewetron.com

Restriction of Hazardous Substances

This product has been classified as Monitoring and Control equipment, and is outside the scope of the 2011/65/EU RoHS Directive. This product is known to contain lead.

Blockdiagram of the internal signal processing

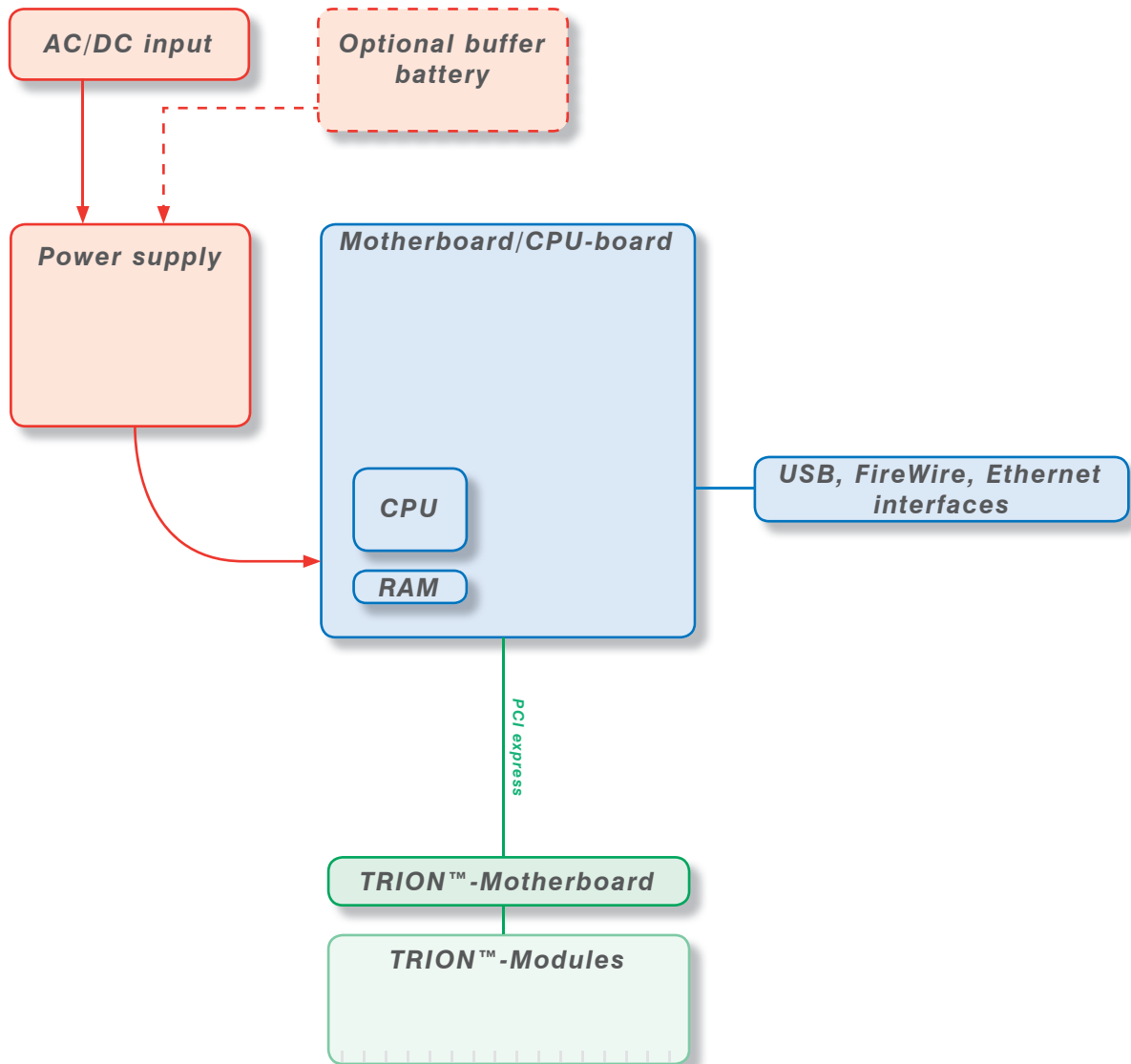

First steps

First steps

1



Power-on your system.

2



Connect your sensors to the system.

3

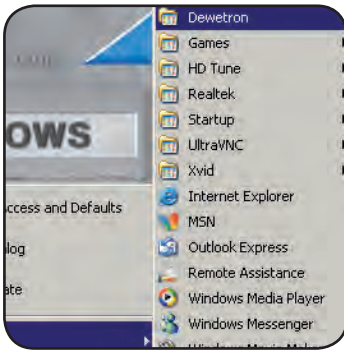

Run DEWESoft usually via "Start" > "Programs" > "Dewetron" > "DEWESoft x.x" > "DEWESoft x.x"

4



Start recording your data!

All accessories shown in this document are available as option and will not be shipped as standard parts. These parts are described as "option".

DEWE2-M13 portable data acquisition mainframe

- 13 slots for TRION™ acquisition modules
- Up to 104 analog inputs
- One internal hard disk and 2 bays for removable disks
- 19" rack-mountable or benchtop use
- Internal PCI slots available

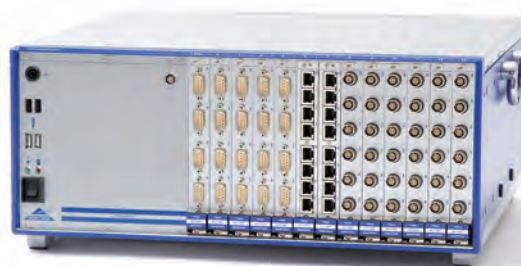

System specifications

DEWE2-M13	
Data acquisition:	13 slots for TRION™ acquisition modules
Rated input voltage:	100 to 240 V _{AC} (max. 90 to 264 V _{AC}), 400 W AC power supply
option DW2-PS-AC-RED:	100 to 240 V _{AC} (max. 90 to 264 V _{AC}) redundant 450 W AC power supply
Typical power consumption:	320 W
Operating temperature:	0 °C to +50 °C, down to -20 °C with prewarmed unit
Storage temperature:	-20 °C to +70 °C
Humidity (operating):	10 % to 80 %, non condensing 5 % to 95 % rel. humidity
Altitude:	up to 2000 m
Sine vibration test ¹⁾ :	Shape Sine
EN 60068-2-6	Frequency range 10 - 150 Hz
	Acceleration 20 m/s ²
	Sweep rate 1 oct./min.
	Duration 20 Cycles
	Test in 3 directions
Random vibration test ¹⁾ :	Shape Random
EN 60721-3-2	Frequency range 10 - 200 Hz
Class 2M2	Spectral acceleration density 1 m ² /s ³
	Duration 30 Minutes/direction
Shocktests ¹⁾ :	Shape Half-sine
EN 60068-2-27	Acceleration amplitude 15 g
	Duration 11 ms
	3 pumps each direction, 6 directions in total
Dimensions (W x H x D):	without feet: 441 x 427 x 177 mm (17.4 x 16.8 x 7 in.)
(with 19" mounting kit):	5U required (4U = unit + 1U = cooling)
Weight w/o TRION™ modules:	typ. 13 kg (28.6 lbs)

¹⁾ Tested with SSD

Main System

Dimensions*

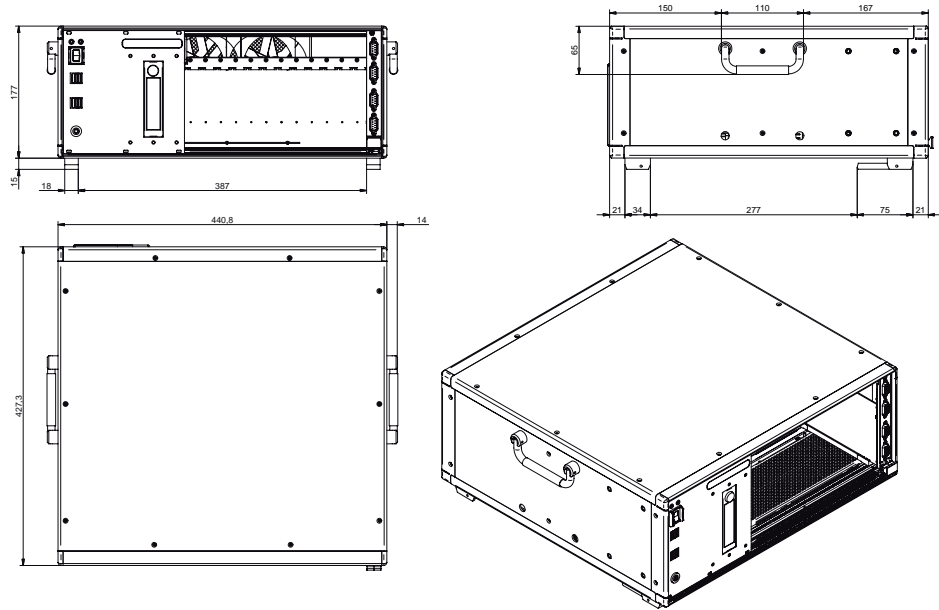

* Dimensions in mm
(1 inch = 25.4 mm)

DEWE2-M13 at a glance

- | | |
|--------------------------------|--------------------------------|
| 1 Chassis terminal | 8 GBit ethernet LAN connectors |
| 2 USB interface connectors | 9 Display port connectors |
| 3 Power-on switch | 10 DVI interface connector |
| 4 EPAD connector | 11 Audio interface |
| 5 TRION™ series module slots | |
| 6 Power supply input connector | |
| 7 Main power switch | |

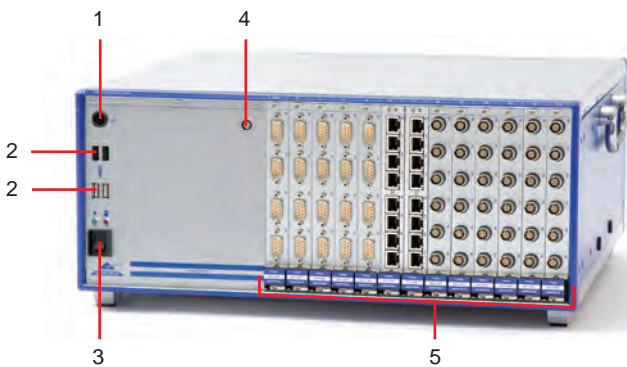

Typical DEWE2-M13 front view

Typical DEWE2-M13 rear view

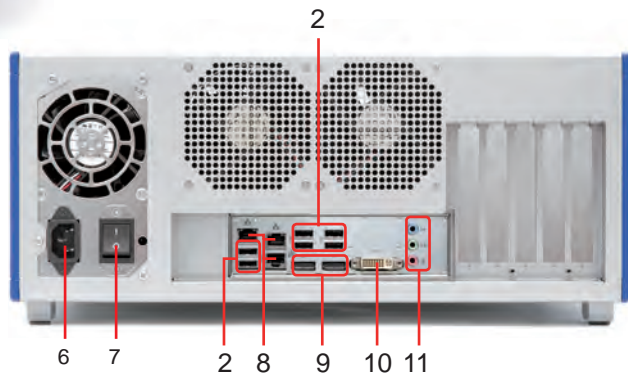

Note: The amount and location of the connectors might vary from system to system and depends on system configuration

1 Chassis terminal

For some kind of measurements, it's necessary to provide the system with an additional ground connection.

2 USB2.0 interface connectors (Universal Serial Bus)

The USB2.0 interface connectors meet standard USB pin assignment.

3 Power-on switch

The power-on switch is used to switch on the system. It only works if the main power switch (7) is on.

4 EPAD connector (LEMO)

To connect DEWETRON EPAD modules to the system.

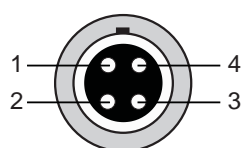

Lemo EGG.1B.304

Pin assignment

1: RS-485 A

2: RS-485 B

3: +12 V

4: GND

Shield is connected on housing

Mating connector:

LEMO FGG.1B.304.CLAD52Z (for cable diameter 4.1 to 5.0 mm)

LEMO FGG.1B.304.CLAD62Z (for cable diameter 5.1 to 6.0 mm)

5 TRION™ series module slots

Slots for TRION™ series modules. For more information about the various modules see chapter "TRION™ series modules overview".

6 Power supply input connector

For details see chapter power supply.

7 Main power switch

The main power switch has to be used to switch on the system.

8 GBit ethernet LAN connector

The DEWE2-M13 system supports 10/100/1000 BaseT Ethernet with standard RJ45 connector.

9 Display ports

The display ports offer the possibility to connect a display to the system and meet standard pin assignment.

10 DVI connector

The DVI connector offers the possibility to connect a displays to the system and meets standard pin assignment.

11 Audio Device







Audio interface connectors (Line In/Out, Microphone)





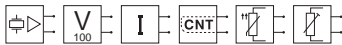
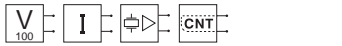

Removable drive bay (option DW2-M13-BAY35-SATA)





The DEWE2-M13 is designed to operate with up to two exchangeable harddisks via a 3.5" SATA removable drive bay for 2.5" harddisk or 2.5" flash disk. The ordering option DW2-M13-BAY35-SATA includes **no harddisk or flashdisk** and has to be ordered separately.





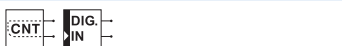



Main System

TRION™ series modules overview

ANALOG Modules 		Channels	Sample rate per channel	Resolution	Isolation	Connector Type
TRION-2402-dSTG		6 to 8	204.8 kS/s	24 bit	no	RJ-45, DSUB, LEMO 1B
TRION-2402-dACC		6 to 8	204.8 kS/s	24 bit	no	SMB, BNC
TRION-1620-ACC		6	2 MS/s 1 MS/s	16 bit 24 bit	yes	BNC
TRION-1620-LV		6	2 MS/s 1 MS/s	16 bit 24 bit	yes	BNC
TRION-2402-V		4 or 8	204.8 kS/s	24 bit	yes	Safety banana sockets
TRION-1603-LV		6	250 kS/s	16 bit	yes	BNC

 Voltage (1000 V)
  Current (shunt needed)
  Bridge
  IEPE
  RTD
  Potentiometer
  SuperCounter™ inputs

DIGITAL Modules 		Channels	Sample rate per channel	Resolution	Isolation	Connector Type
TRION-CNT		6 to 18	800 kS/s	80 MHz	yes	DI, CNT
TRION-DI-48		48	2 MS/s	80 MHz	yes	DI
TRION-BASE		1 to 8	2 MS/s	80 MHz	-	DI, DIO, CNT, SYNC, AUX
TRION-TIMING		1 to 8	2 MS/s	80 MHz	-	GPS antenna, IRIG In / Out, DIO, CNT, SYNC, AUX

DEDICATED Modules 		Channels	Sample rate per channel	Resolution	Isolation	Connector Type
TRION-CAN		2 or 4	n/a	n/a	yes	DSUB
TRION-FLEXRAY		1	n/a	n/a	-	DSUB
TRION-VGPS		1 CNT 8 DIO	2 MS/s	0.01 km/h < 10 cm	-	GPS antenna, IRIG In / Out, DIO, CNT, SYNC, AUX
TRION-A429		4, 8, 16 or 30	-	n/a	-	SCSI-3
TRION-M1553		1,2 or 4	-	n/a	-	SCSI-3
TRION-MA4		9, 10, 12 or 13	-	n/a	-	SCSI-3
TRION-1628-AO-2		Update rate max. 2.8 MS/s	2	16 bit	-	BNC

NOTE: The TRION-TIMING module has to be installed in the STAR-slot for TRION™ modules. Further information regarding the STAR-slot for TRION™ modules refer to TRION™ series modules technical reference manual.

NOTE: Some dedicated modules (TRION-A429, TRION-M1553, TRION-MA4) require additional -12 V_{DC} voltage which is not supported with DC powered DEWE2 instruments by default. Please ask your local dealer or factory for more information.

Installing a TRION™ module in the chassis

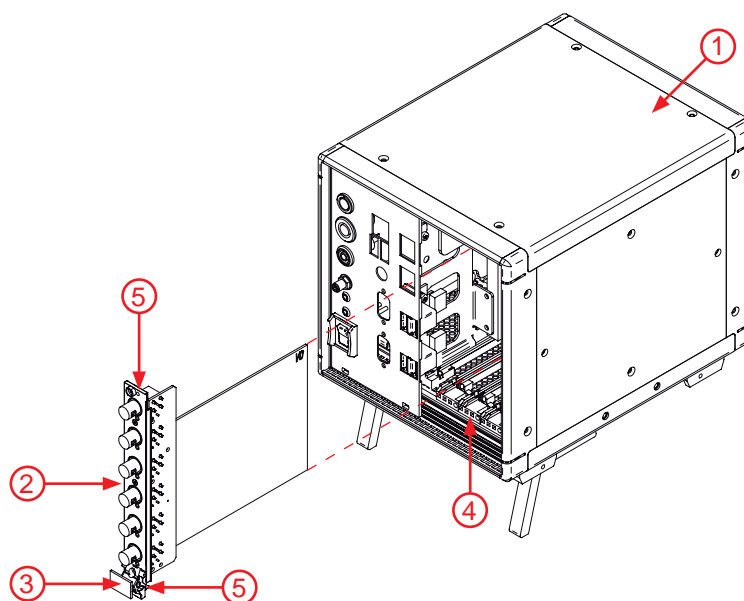

- 1 DEWE2 chassis
- 2 TRION™ series module
- 3 Injector/ejector handle
- 4 Module guides
- 5 Mounting screws

Step 1:  Proper ESD precautions must be taken to avoid any damage to the unit.

Step 2: Power off and unplug all connected cables including sensors from the DEWE2 chassis and TRION™ series modules.

Step 3: Identify a supported TRION™ peripheral slot.
Some modules require a TRION™ STAR-slot. For more information please see chapter: "STAR-slot for TRION™ modules.

Step 4: Remove the filler panel of an unused TRION™ peripheral or STAR-slot.

Step 5: Place the module edges of the TRION™ modules into the module guides at the top and bottom of the chassis.

Step 6: Insert the TRION™ module to the rear of the chassis until a resistance appears.

Step 7: Pull up on the injector/ejector handle to latch the device

Step 8: Secure the installed TRION™ front panel to the chassis using the mounting screws.

WARNING: *Unused TRION slots must not remain uncovered! Make sure to reinstall the filler panels of unused TRION™ slots to guarantee proper cooling of the installed modules. WARRANTY VOID if the modules overheat due to missing filler panels!*



Main System

Power supply

Standard AC power supply

400 W AC power supply BEA-640	
Input:	
Rated input voltage:	100 to 240 V _{AC} (max. 90 to 264 V _{AC}); active PFC
Input frequency:	47 to 63 Hz
Max. input current:	7 A (115 V _{AC}), 3.5 A (230 V _{AC})
Output:	
Output power:	max. 400 W
Output voltages:	+3.3 V (max. 28 A)
	+5 V (max. 35 A) -5 V (max. 0.5 A)
	+5 V _{sb} (max. 2 A)
	+12 V (max. 30 A) -12 V (max. 0.8 A)

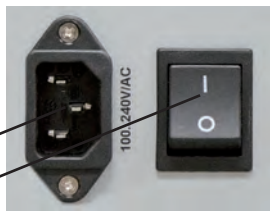

AC power supply

AC power switch

Optional redundant AC power supply for DEWE2-M13 (option DW2-PS-AC-RED)

450 W AC power supply	
Input:	
Rated input voltage:	100 to 240 V _{AC} (max. 90 to 264 V _{AC}), active PFC
Input frequency:	47 .. 63 Hz
Input current:	7 A (115 V) / 3 A (230 V)
Output:	
Output power:	450 W total
Output voltages:	+12 V (max. 37 A)
	+5 V (max 25 A)
	+3.3 V (max 25 A)
	-12 V (max. 0.8 A)
	+5 V _{sb} (max. 3.5 A)
Protection:	
Short circuit protection:	At each output
Overload protection:	110 .. 160 %
Overvoltage protection:	+3.3 V (+3.6 .. +4.3 V), +5 V (+5.6 .. +6.5 V), +12 V (+13.2 .. +15.6 V)

This option adds an additional AC power supply input connector in case one power supply rack fails. The other rack takes over the full load without any interruption.



AC power switch

AC power supply

Maintenance

Battery

The battery in PC is CR 2032. It is allowed to replace this battery only by the same type. Replaceable only by serviceman.

Fuse

Fuse in power supply: F1 T8A or T6.3 A / 250 V. Replaceable only by serviceman.



Battery and fuse exchange has to be done by qualified persons only!

Installing the optional 19" mounting kit

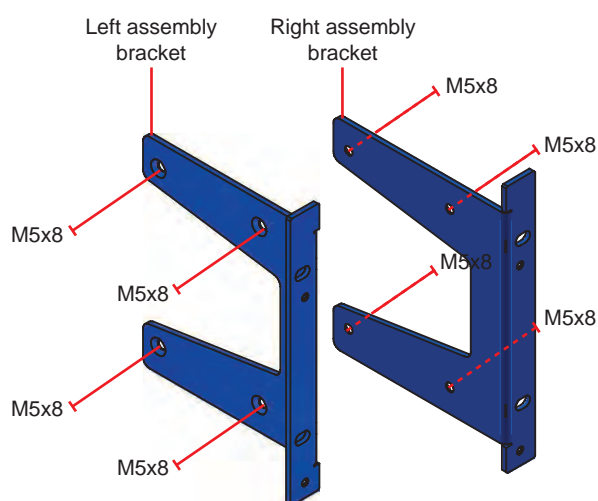

WARNING: *When installing the 19" mounting brackets, the maximum length for screws is 8 mm! If any screw get lost replace it with M5x8 countersunk head screw only. Otherwise the TRION™ series cards or the powersupply could get damaged!*



System recovery

For more information regarding a total recovery please refer to the corresponding total recovery technical reference manual shipped with your DEWE2 system.

Main System

Notes

Synchronization of DEWE2

Synchronization of multiple DEWE2 devices

To create high channel count systems, or for distributed measurements, DEWE2 instruments support multiple synchronization options. The synchronization method of choice is depending on the distance between the instruments.

Synchronization via TRION-SYNC-BUS (CATVI cable) is limited to ~100 meters.

Synchronization via IRIG time-code is limited to ~1000 meters.

Synchronization via GPS is not limited.

1.0 Installation of DEWESoft and TRION™ hardware drivers

Usually your DEWE2-Ax / DEWE2-Mx system comes with preinstalled DEWESoft and TRION™ hardware drivers and do not need any further actions. In case of a DEWE2-Fx front-end it is necessary to install DEWESoft and the TRION™ hardware drivers on your PC or laptop. Connect the DEWE2-Fx front-end to your laptop/PC via the shipped PCIe/PXI cable. The Windows® 7® device manager will find some new hardware but can not install the correct drivers. To install the TRION™ hardware drivers navigate to <<..files\drivers\6_daqboards\dewetron\trion_driver>> on the USB flash drive shipped with your instrument. Then execute the "DeweDevSetup.exe" and follow the DEWETRON driver installation wizard.

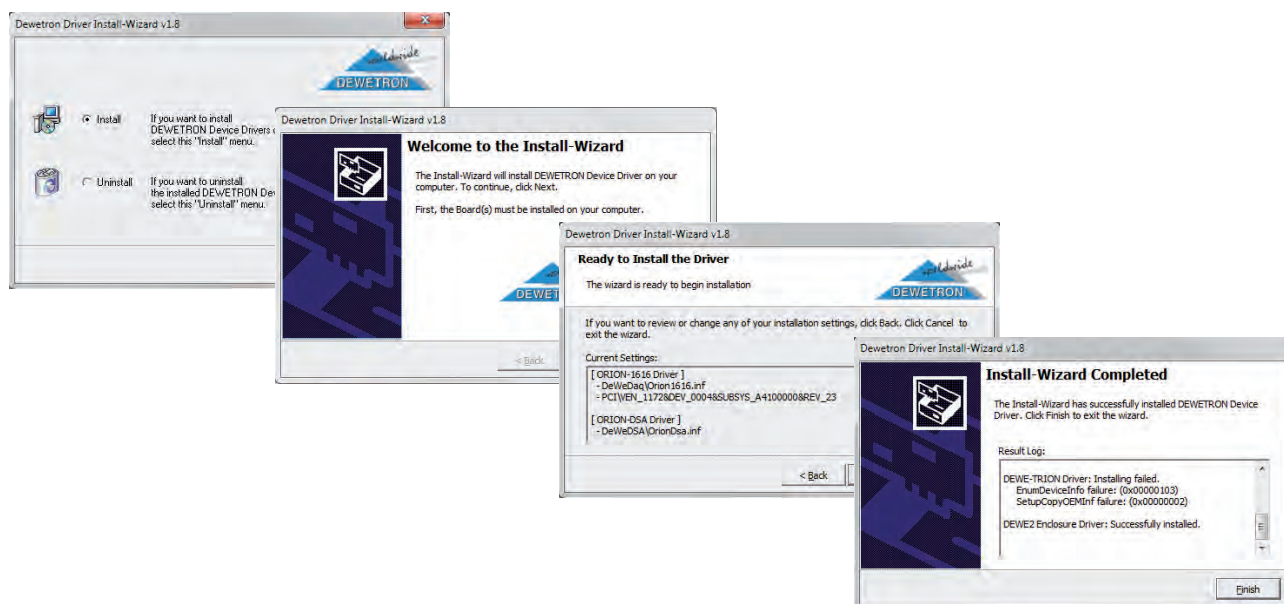

DEWESoft installation

If the installation software doesn't start when you insert the DEWE-System DVD into the computer, start it manually by clicking on the **ShelExec.exe** file on the DVD or navigate to "HTML" and start the **index.html**. Follow the instructions of the installer.

1.1 DEWE2Explorer

Your DEWE2 instrument is equipped with the new DEWE2Explorer, in case of a DEWE2-Fx front-end make sure to start the DEWE2Explorer.exe from the USB flash drive via <<..files\drivers\6_daqboards\dewetron\trion_driver>> shipped with your instrument.

The DEWE2Explorer gives an overview of your System and the installed TRION™ series modules. It represents a relieving extension to the device manager of Windows®. With this tool it is possible to check for firmware updates of the installed cards or perform self tests. Furthermore the level of logfile generation can be adjusted by the DEWE2Explorer. The screenshots on the next page will demonstrate how to work with this tool.

Synchronization of DEWE2

The main screen "System" shows information about the system and the installed TRION™ series modules.

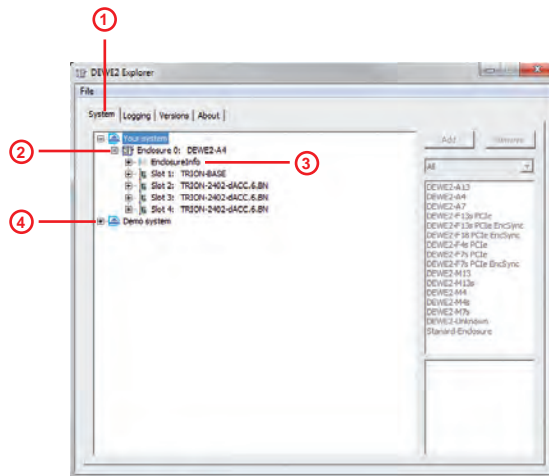

DEWE2Explorer system tab

- 1.) System tab.
- 2.) By expanding "Your system" an overview of the DEWE2 chassis, the installed TRION™ series modules and synchronization option (Enclosure sync) is given.
- 3.) Expanding the EnclosureInfo menu will show you detailed information about the DEWE2 chassis (e.g. Name, Revision, Sync, Powersupply,...)
- 4.) With the "Demo System" menu it is possible to create your own virtual DEWE2 system and simulate the particular configuration in DEWESoft.

NOTE: "Your system" is not changeable! This data is read directly from the DEWE2 unit! After powering-off the DEWE2 unit and installing any additional TRION™ series module, the DEWE2Explorer automatically recognizes the new installed module! No further setup is required!

1.1.1 Running a demo system

When clicking on "Demo system" the list of instruments on the right side becomes available. To add a system just double-click on the desired DEWE2 instrument or hit "Add". On the bottom right corner a picture of the selected DEWE2 instrument appears. The "Remove" button allows you to remove an existing demo system.

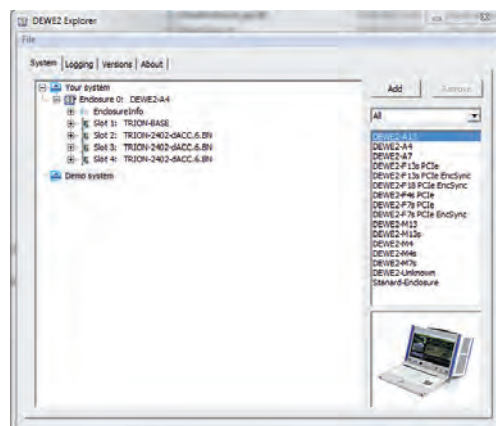

DEWE2Explorer: adding a demo system

Synchronization of DEWE2

After the DEWE2 system has been chosen you can fill up the empty slots of the instrument with the desired TRION™ series modules.

The list on the right side gives you an overview of existing cards and models. To add a card simply double-click the desired interface card or hit "Add". The "Remove" button allows you to remove an existing card.

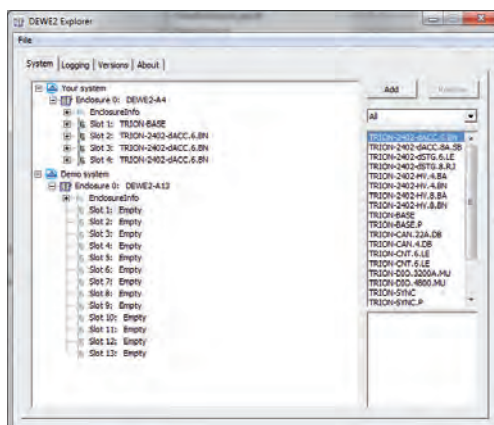

DEWE2 Explorer: Filling up of empty slots

1.1.2 Self test & Firmware update of TRION™ series modules

By right-clicking on "Enclosure x:" a menu pops up where it is possible to perform some additional actions to the TRION™ series card.

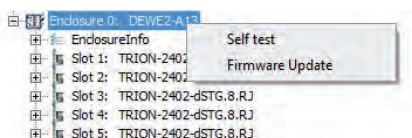

DEWE2 Explorer: Self test & Firmware update

The option "Self test" allows to perform a self test of the installed TRION™ series modules. A new window will pop-up and show some information about the installed modules in the corresponding slots. "NOT PERFORMED" is shown if the self test has not been performed yet. To start the self test simply click on "Perform Self Test".

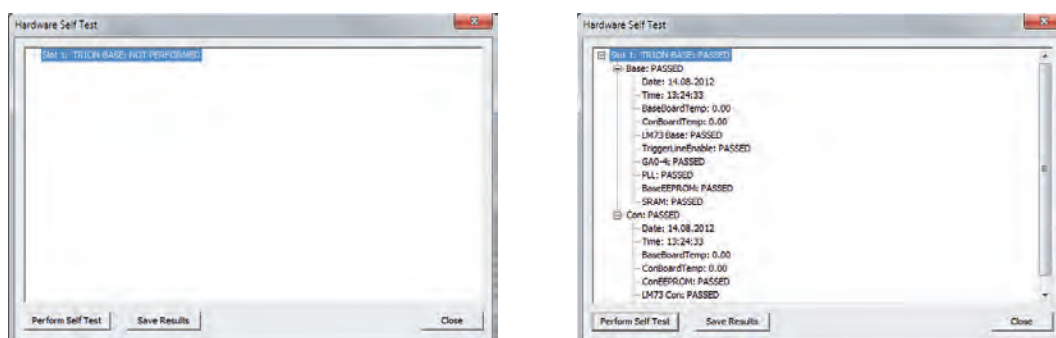

DEWE2 Explorer: Performing self test and results

After the self test is performed a "PASSED" or "NOT PASSED" will inform you about the process. Some additional information is given which operation did/did not pass the test. The button "Save Results" allows to save the self test results in .xml format to subsequently start error diagnostics.

Synchronization of DEWE2

The option "Firmware Update" allows to perform firmware updates of the installed TRION™ series modules. In the pop-up window hit "Yes" to perform the update.

WARNING: Please do not switch off the modules during the update process! Power cycle the system after the firmware update!

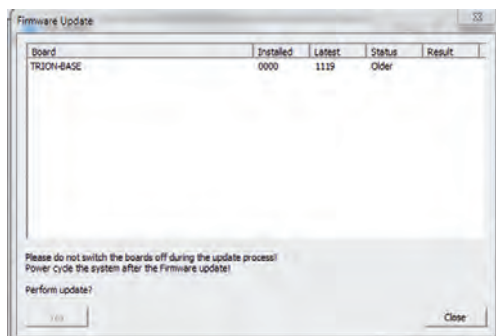

DEWE2Explorer: Firmware update

NOTE: A firmware update should be done only if DEWETRON recommends this update! At delivery, the latest firmware revision of each module is already installed!

1.1.3 Versions tab

The versions tab shows some information of the used DEWE2Explorer, TRION™ application library, system driver, DEWE2 enclosure application library as well as TRION™ board and firmware information.

1.1.4 About tab

Company-related information.

Synchronization of DEWE2

1.2 DEWESoft hardware settings

WARNING: YOU MUST NOT RUN DEWE2EXPLORER AND DEWESOFT AT THE SAME TIME! MAKE SURE TO CLOSE THE DEWE2EXPLORER AND START DEWESOFT AFTERWARDS! OTHERWISE DEWESOFT WILL NOT INITIALIZE THE HARDWARE AND AN ERROR ("NO HARDWARE FOUND") OCCURS!

After starting DEWESoft 7.x make sure to select "Dewetron Trion" (1) as your analog device in the hardware settings. To modify the hardware settings, select "Settings - "Hardware setup" in the menu. The DEWE2 system with the installed TRION™ series A/D modules are listed in "TRION™ module information".

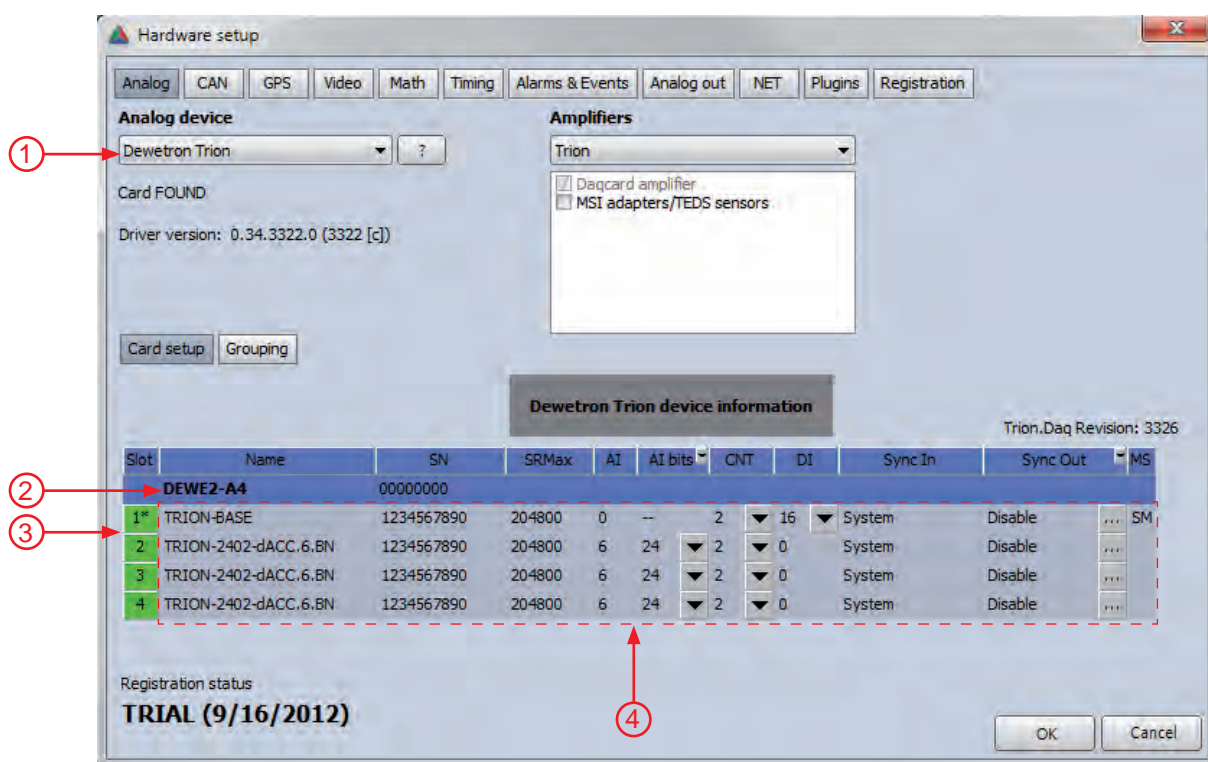

- ② Chassis info
- ③ Slot number
- ④ TRION™ module information

If more than one DEWE2 instrument is used, the "Dewetron Trion device information"-window becomes scrollable and lists all DEWE2 instruments with the corresponding TRION™ series modules.

Slot	Name	SN	SRMax	AI	AI bits	CNT	DI	Sync In	Sync Out	MS
	DEWE2-A4 (0)	00000000								
1*	TRION-BASE	1234567890	204800	0	--	2	16	System	Disable	SM
2	TRION-2402-dACC.6.BN	1234567890	204800	6	24	2	0	System	Disable	...
3	TRION-2402-dACC.6.BN	1234567890	204800	6	24	2	0	System	Disable	...
4	TRION-2402-dACC.6.BN	1234567890	204800	6	24	2	0	System	Disable	...
	DEWE2-A7 (1)	00000000								

Synchronization of DEWE2

2.0 Overview of DEWE2 chassis

First of all, there are different kinds of DEWE2 instruments available.

DEWE2 All-In-One Instruments



	DEWE2-A4	DEWE2-A7	DEWE2-A13
Slots for TRION™ acquisition modules	4	7	13

DEWE2 Mainframes



	DEWE2-M4s	DEWE2-M4	DEWE2-M7s
Slots for TRION™ acquisition modules	4	4	7



	DEWE2-M13s	DEWE2-M13
Slots for TRION™ acquisition modules	13	13

DEWE2 Front End



	DEWE2-F4s	DEWE2-F7s	DEWE2-F13s	DEWE2-F18
Slots for TRION™ acquisition modules	4	7	13	18

Synchronization of DEWE2

2.1 Definition of a Standalone unit

A standalone unit is defined either as a DEWE2-Ax, DEWE2-Mx or DEWE2-Fx (with a PC/laptop) by running DEWESoft 7.x on the instrument. If the DEWE2-Fx front-end is connected with the PC/laptop via the PCIe interface, DEWESoft recognize this as one unit. To guarantee a high data throughput, DEWETRON recommends max. 7 meters cable length for PCIe connection.

In DEWESoft click "Settings" > "Hardware setup" > "NET" and make sure to check "Standalone unit". This basic knowledge is important to proceed with the next steps of the synchronization chapter.

The schematics below show the principle of a standalone system.



The DEWE2-Ax series instrument is a All-in-one instrument with an integrated CPU and display running DEWESoft 7.x.



The DEWE2-Mx series is a mainframe with an integrated CPU by running DEWESoft 7.x on it. With an additional connected display, the DEWE2-Mx equals a DEWE2-Ax.

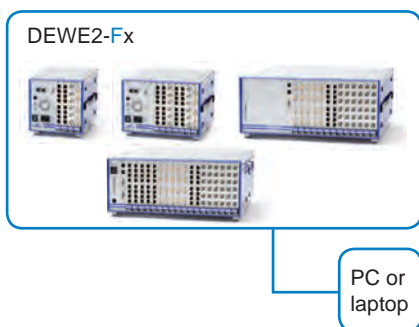

The DEWE2-Fx series is a front-end which has no integrated CPU. To run a DEWE2-Fx front-end as a standalone unit, it is necessary to connect a PC/laptop running DEWESoft 7.x. With the connected PC/laptop the DEWE2-Fx device equals a DEWE2-Mx or DEWE2-Ax series instrument.

Summary:

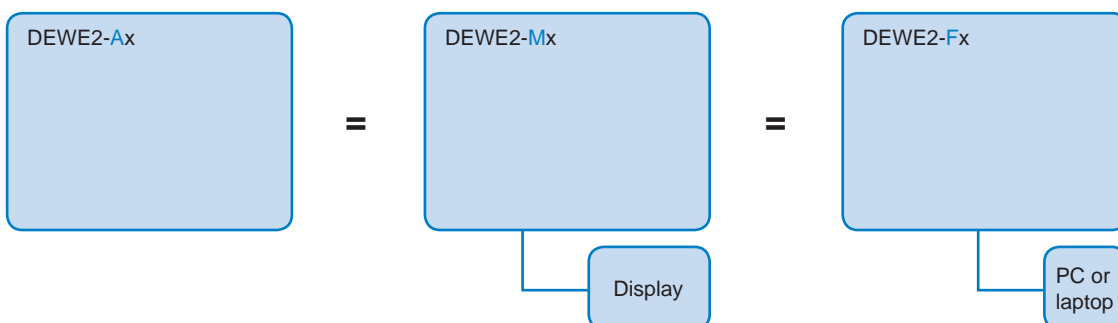

Synchronization of DEWE2

2.2 Definition of a Main system

For simplification the following configuration is defined as "**Main system**". With this **main system** it is possible to synchronize to all DEWE2 series instruments as well as ORION DAQ based systems (ORION-0816-xxx, ORION-1616-xxx) in conjunction with a TRION-BASE module, explained in the following chapters of this technical reference manual.

2.2.1 Video synchronization

Any TRION-TIMING /-BASE module has the possibility to route a couple of signals to the "AUX"-connector. The video-sync supports hardware synchronized video of up to 200 frames per second, which are accurate per sample and without delay. The camera is clocked by the DEWE2 instrument. The video sync also supports software synchronized low-cost video (USB or PAL/NTSC cameras) for optimized low latency and compensated delay of USB cameras, as well as high speed videos up to 500 000 frames per second (online sync for Photron cameras, post sync for any high speed .avi files). If additional video synchronization is needed, select "Video" as AUX output in synchronization options in DEWESoft.

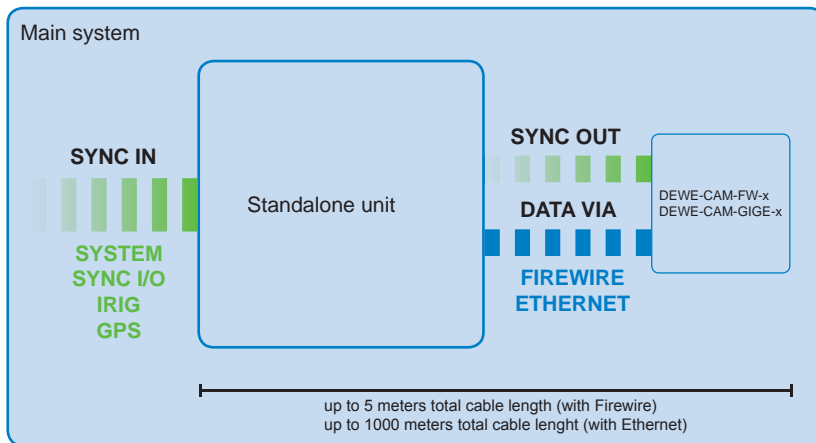

Synchronization of DEWE2

2.3 Definition of SyncIn/Out & AUX

With DEWE2 instruments there is nearly no limit when synchronizing systems with each other. As already mentioned in chapter "Synchronization overview of DEWE2 systems", the synchronization of the devices is either done via TRION-SYNC-BUS (SYNC I/O, SYNC OUT), IRIG (external source or internal generator), PPS (external source or internal generator) or GPS. The synchronization options are depending on model and configuration of DEWE2 instruments.

- The **synchronization input** represents the input configuration of a device on how this instrument "gets" the input signal from any source or "generates" an input signal.
- The **synchronization output** represents the output configuration of a device, which defines what kind of signal this instruments routes to the corresponding output, in order to synchronize with the next connected device.

All DEWE2 units need some special treatment in DEWESoft in terms of synchronization. In the "Analog" tab via "Settings" > "Hardware setup" > "Analog" select your system with the installed TRION™ series modules and click the grey box next to "Sync Out" column. The "Star slot" is marked with "1*" in the left-hand green column. If the system is equipped with a TRION-BASE /-TIMING board, it has to be installed in the "star slot".

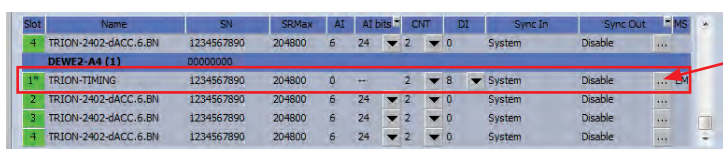

Slot	Name	SN	SRMax	AI	AI bits	CNT	DI	Sync In	Sync Out	MS
4	TRION-2402-dACC.6.BN	1234567890	204800	6	24	2	0	System	Disable	...
DEWE2-A4 (1)										
1*	TRION-TIMING	1234567890	204800	0	...	2	8	System	Disable	...
2	TRION-2402-dACC.6.BN	1234567890	204800	6	24	2	0	System	Disable	...
3	TRION-2402-dACC.6.BN	1234567890	204800	6	24	2	0	System	Disable	...
4	TRION-2402-dACC.6.BN	1234567890	204800	6	24	2	0	System	Disable	...

- Synchronization options in DEWESoft:

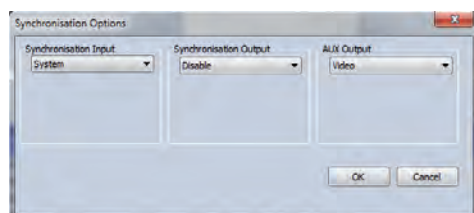

Some TRION™ series modules (TRION-TIMING /-BASE) support an additional SMB connector, labelled "AUX" on the front panel. It is possible to route some signals to SMB connector, e.g. Video, Trigger, Acquisition clock, Frequency or PPS.

For more details please refer to chapter: "Synchronziation options in DEWESoft™ (Part II)

Synchronization of DEWE2

2.4 Synchronization options in DEWESoft™ (part I)

This chapter will give a detailed explanation of the synchronization options in DEWESoft™ and will describe the function of the LEDs of the TRION-SYNC-BUS and the IRIG-sync option.



With this option the internal 10 MHz clock is used as the clock source in this particular DEWE2 system.



The TRION-SYNC-BUS (SYNC I/O, SYNC OUT) is used to synchronize two or more DEWE2 systems with up to 100 m distance between each node. The 10 Mhz clock signal, along with acquisition control signals, is transmitted via the RJ-45 connection. The TRION-SYNC-BUS consists of two RJ-45 sockets. One socket being a synchronization OUT, whilst the other one could either be used as synchronization IN or OUT.

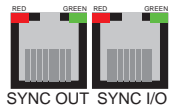

LED indication:

	SYNC OUT	SYNC I/O
RED (stable)	Clock detected	Clock detected / Receiving clock
GREEN (stable)	Acquisition running	Acquisition running

Depending on the usage of the SYNC I/O (input or output) the LED indicates if the system clock is available or received correctly from another system. The green LED indicates that the acquisition is running. If the acquisition stops the LED will be off.



This option is used for synchronization with legacy DEWE1 systems, e.g. ORION-DAQ. The clock and trigger signals of the DEWE2 series instrument are routed to the SYNC I/O connector and in parallel to the DIO connector of any TRION-BASE module if installed. Please refer to part II of synchronization options in DEWESoft™ for detailed information.

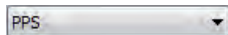

PPS: Pulse per second, usually from a GPS receiver or ADMA gyro.



Supported IRIG mode:

Input: IRIG A/B - AC/-DCLS (direct current level shift).

Output: IRIG B - DC

The IRIG timecode is used to control a PLL, which is then used as the system timebase. The IRIG connector also has an indication LED flashing either green or red:



LED indication:

	OFF	ON	Description
GREEN (flashing)	20 %	80 %	SYNC IN not available
RED (flashing)	80 %	20 %	SYNC detected, not locked
GREEN (flashing)	80 %	20 %	SYNC detected and locked

Synchronization of DEWE2

2.5 Channel expansion (up to 7 meters cable length)

One popular application is to use F-series devices with a laptop computer for mobile applications as described above (Standalone unit). The second use of F-series devices is to expand **main systems** (DEWE2-Ax or -Mx series instruments). This option is described in the following chapter. Multiple units can be daisy-chained. DEWETRON recommends max. 7 devices connected to a **main system**. The following examples will explain the principle of daisy chaining.

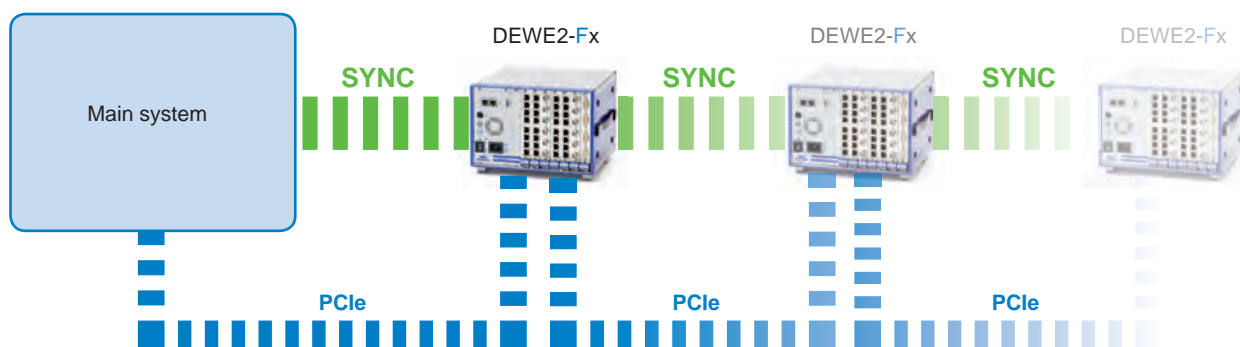

Schematic representation

2.5.1 Channel expansion with TRION-SYNC-BUS (Sync I/O)

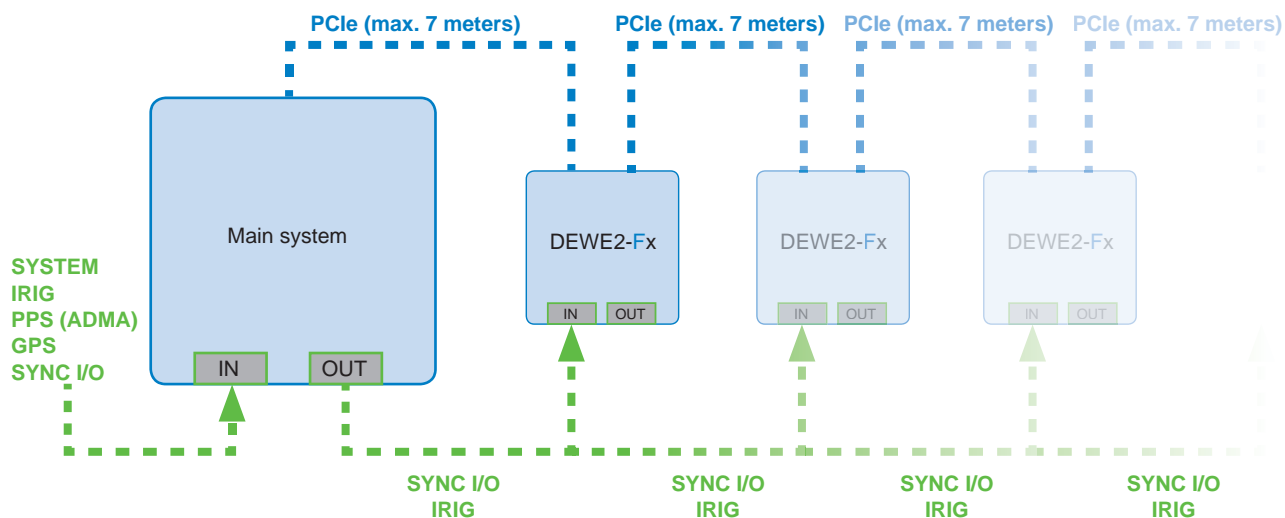

- Synchronization options in DEWESoft™:

Synchronization input:

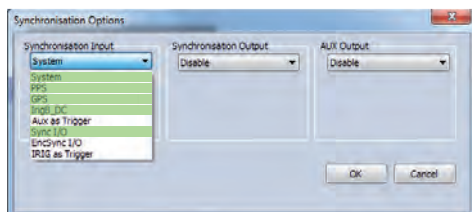

Synchronization output:

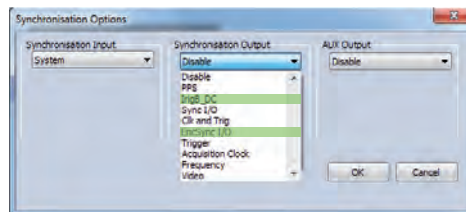

Synchronization of DEWE2

2.5.2 Channel expansion with IRIG (external IRIG generator)

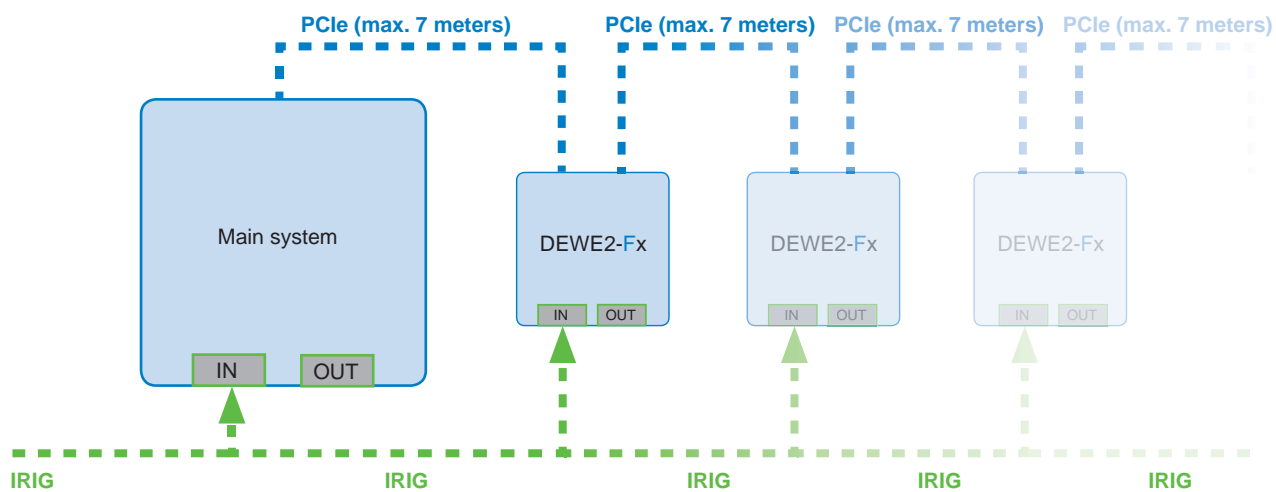

- Synchronization options in DEWEsft™:

Synchronization input:

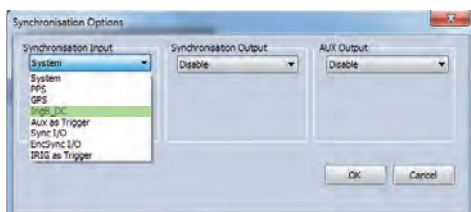

Synchronization of DEWE2

2.6 Sync with option „NET“ (up to 1000 meters cable length)

With DEWE2 series instruments it is also possible to synchronize "standalone units" running DEWESoft™ on each unit. This synchronization method is called "NET" and is required as an option in DEWESoft™.

The following examples will explain the principle of "NET" option:

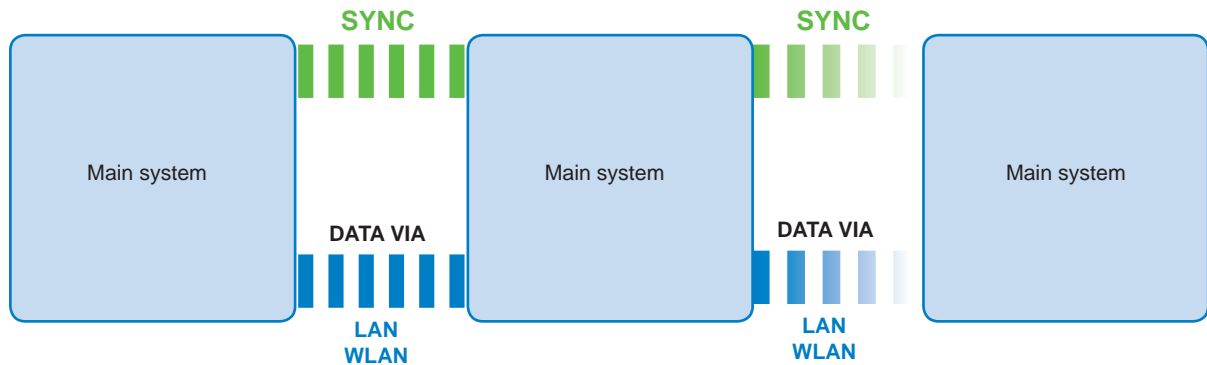

Schematic representation: daisy chaining

Synchronization of DEWE2

2.6.1 "NET" synchronization with TRION-SYNC-BUS (SYNC I/O, SYNC-OUT)

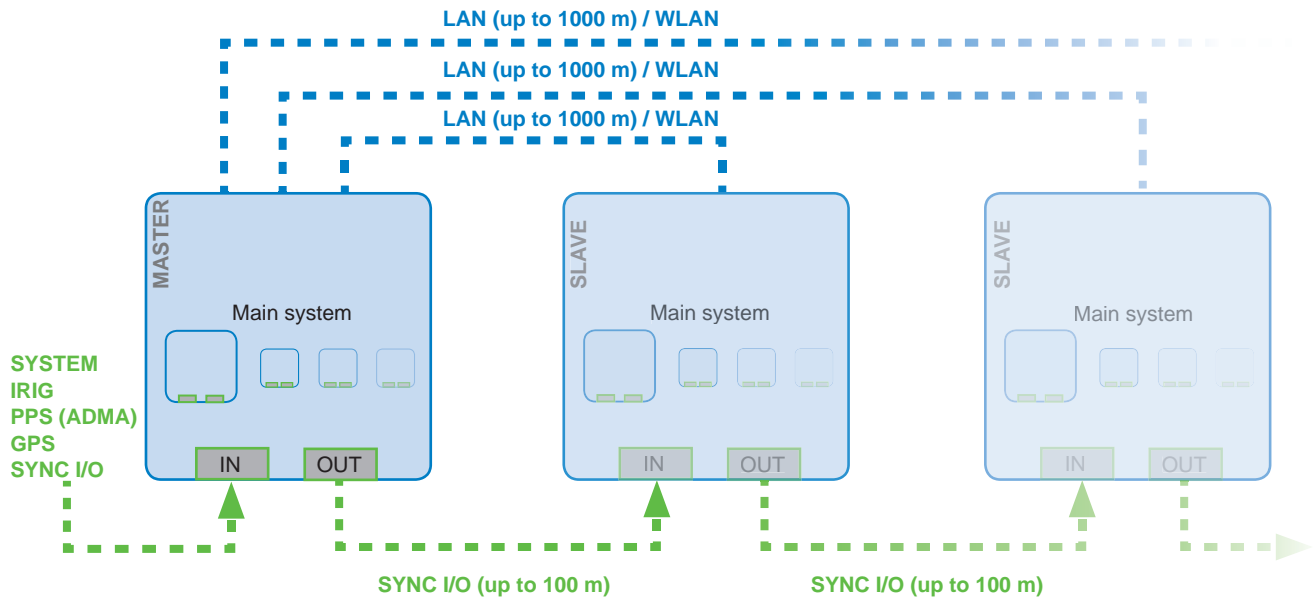

- Synchronization options in DEWESoft™:

MASTER:

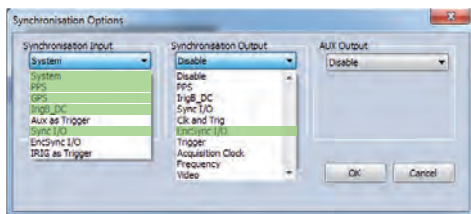

SLAVE:

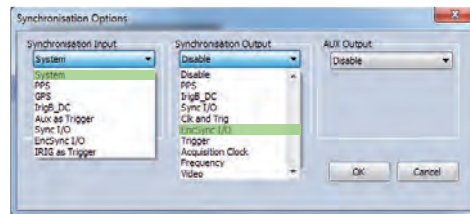

2.6.2 "NET" synchronization with external IRIG & GPS (external IRIG / GPS source)

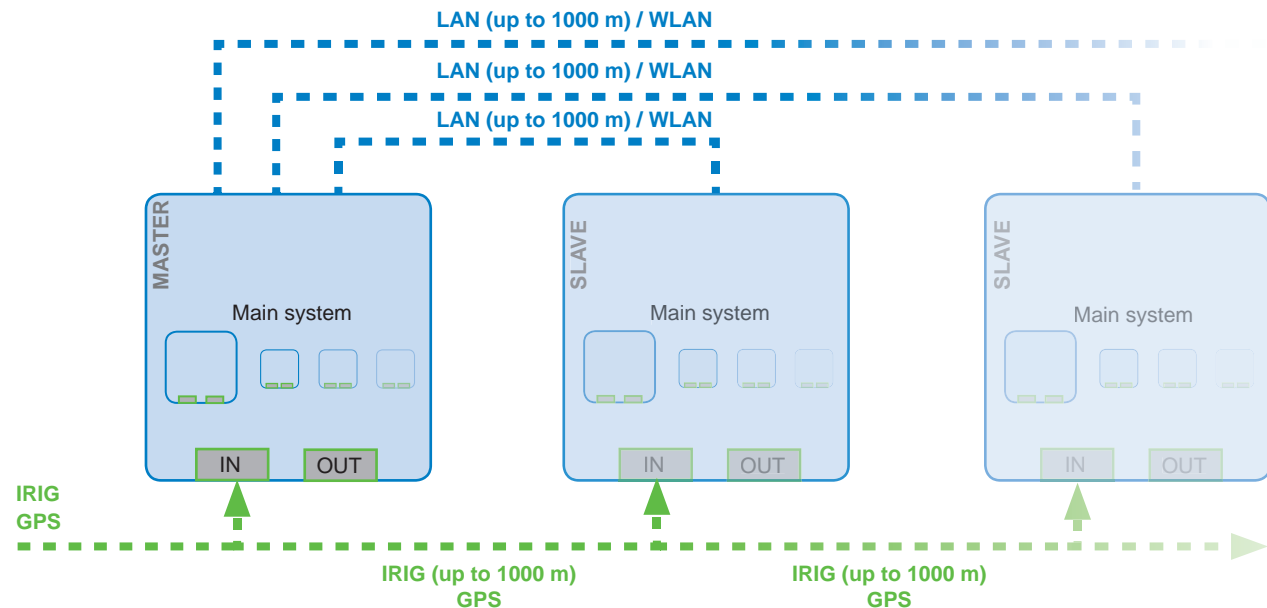

Synchronization of DEWE2

- Synchronization options in DEWESoft™:

MASTER:

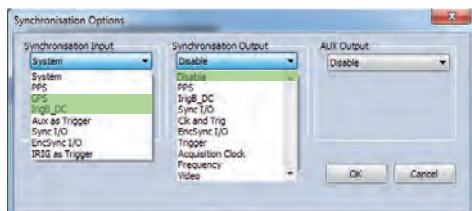

SLAVE:

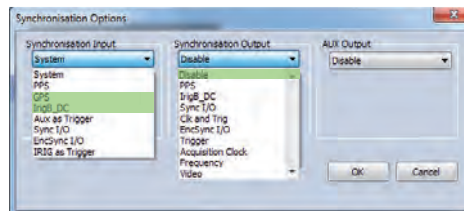

2.6.3 "NET" synchronization with GPS only (no distance limitation if WLAN is used)

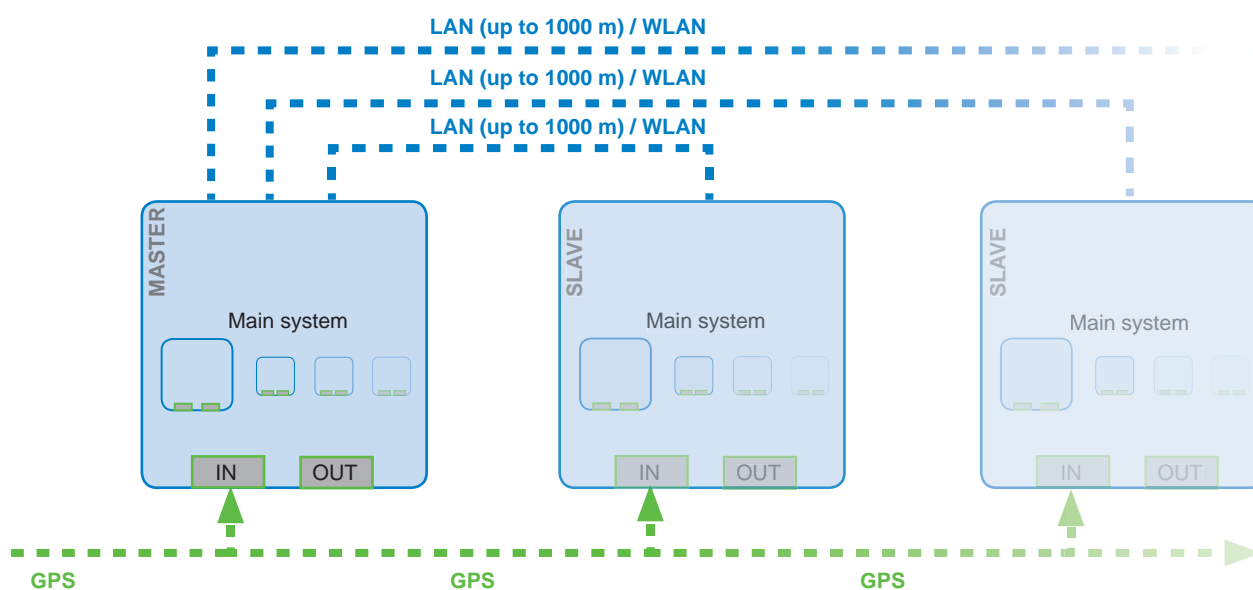

- Synchronization options in DEWESoft™:

MASTER:

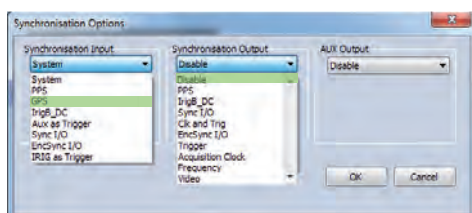

SLAVE:

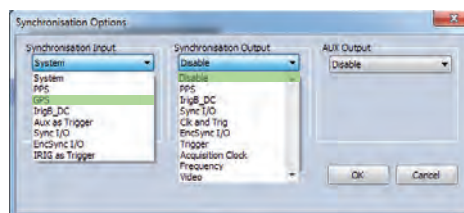

Synchronization of DEWE2

2.7 Defining a Master / Slave unit

It is necessary to define one master measurement system and any slave measurement units when instruments should be synchronized. Each unit must run DEWESoft™.

NOTE: This synchronization requires option DEWESOFT-OPT-NET!

To define a master measurement unit click on "Settings" > "Hardware setup" > "NET" and choose "Master measurement unit" from the dropdown list.

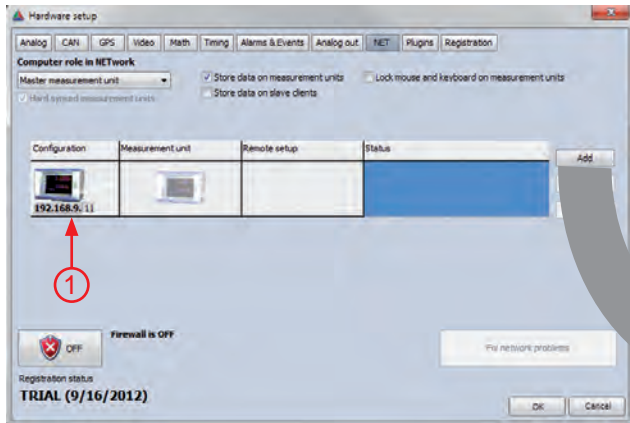

By setting up a master measurement unit it is possible to define some additional features like "Store data on measurement units", "Lock mouse and keyboard on measurement units" and "Store data on slave clients". In the configuration window (1) the current master measurement instrument with the IP-address is shown. Clicking "Add" opens a new window where all standalone measurement units in your network are listed.

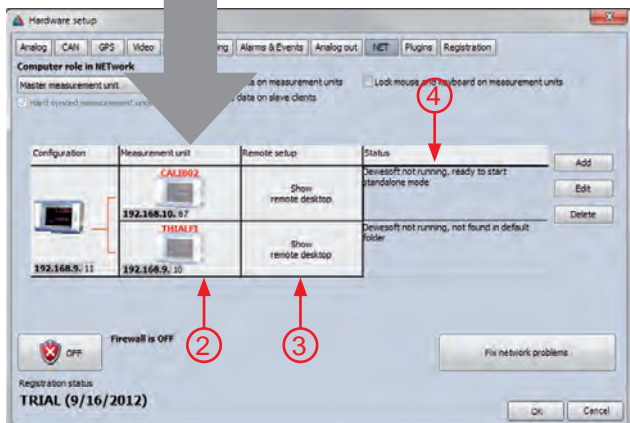
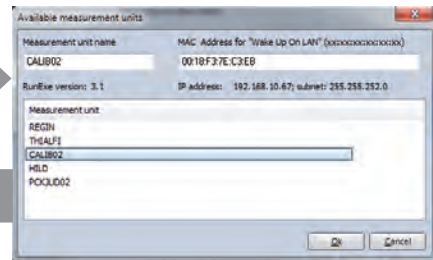

NOTE: All instruments must have the same subnet mask and IP-range otherwise no units can be found!

*EXAMPLE: Subnet mask: 255.255.255.0
IP-Addresses: 192.168.10.x*

In the measurement unit window (2) the slaves are now visible. Via the remote setup window (3) you are able to remotely setup your measurement units. In the status window (4) some additional information about the slave measurement units are given.

Synchronization of DEWE2

NOTE: After adding the instruments it is also necessary to configure them as "slave measurement units" in DEWESoft. The systems are configured as "Standalone unit" by default.

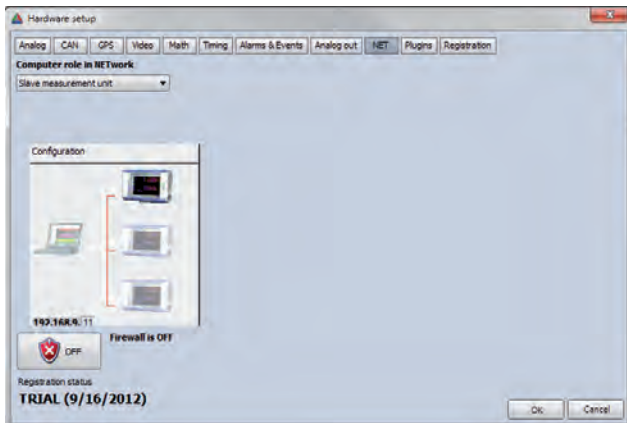

To do so you can either remote control the slave unit by clicking on "Show remote desktop" (③) on the master unit or execute this locally on the slave units. At the slave unit click "Settings" > "Hardware setup" > "NET" and choose "Slave measurement unit" from the dropdown list. Hit "Ok" to store the configuration.

Now you have successfully configured master and slave measurement units.

In DEWESoft an additional menu called "NET" is created. With this menu it is possible to:

- close DEWESoft on measurement units
- reboot measurement units
- shutdown measurement units
- wake-up measurement units

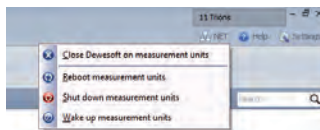

Synchronization of DEWE2

2.8 Synchronization of DEWE2 devices with ORION-DAQ series boards

With the new DEWE2 devices it is also possible to synchronize with older DEWETRON instruments using DEWE-ORION-0816-xxx or DEWE-ORION-1616-xxx series A/D boards. This option requires a TRION-BASE /-TIMING module in the DEWE2 instrument and at least a "Digital I/O" connector or ORION-SYNC interface at the DEWETRON instrument.

Theory of operation:

The synchronization option in DEWESoft allows to configurate the synchronization output of a TRION-TIMING /-BASE module. With this option it is possible to set the clock and trigger signals as outputs on the "DIO" connector of the TRION-TIMING /-BASE module. As a special feature the clock and trigger signals are routed in parallel to the "Sync I/O" connector of the TRION-TIMING module. With this special feature it is possible to connect the TRION-SYNC-BUS with the ORION-SYNC-BUS. The schematic below will show the principle of the synchronization option.

2.8.1 Synchronization of DEWE2 systems with ORION-DAQ systems

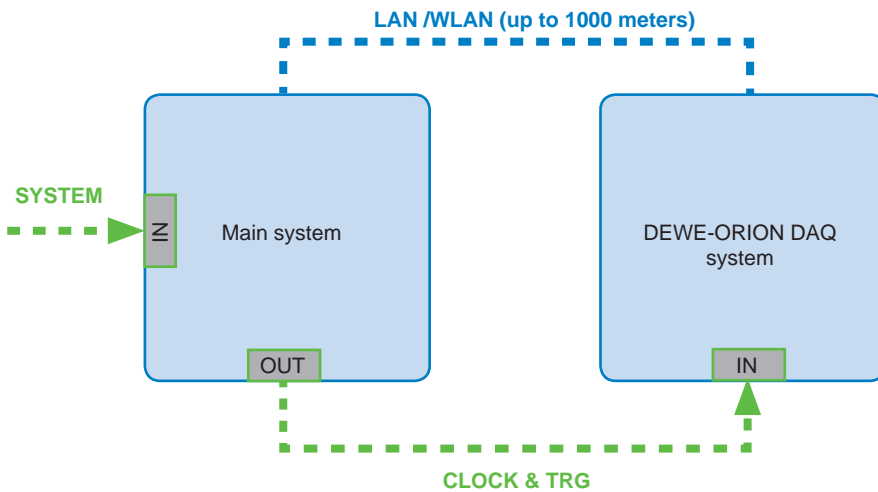

When choosing "CLOCK & TRG" as synchronization output at the master system, the signals are routed automatically to the "DIO" connector. Please refer to chapter "2.9 Synchronization options in DEWESoft" for detailed information

Synchronization of DEWE2

2.9 Synchronization options in DEWESoft™ (part II)

When defining a particular synchronization input it is not always possible to have this as synchronization output also. This chapter gives a detailed overview of the synchronization input and output. The schematics below will give an overview of possible configurations in DEWESoft™:

Synchronization options w/o TRION-TIMING /-BASE module (TRION-SYNC-BUS only)

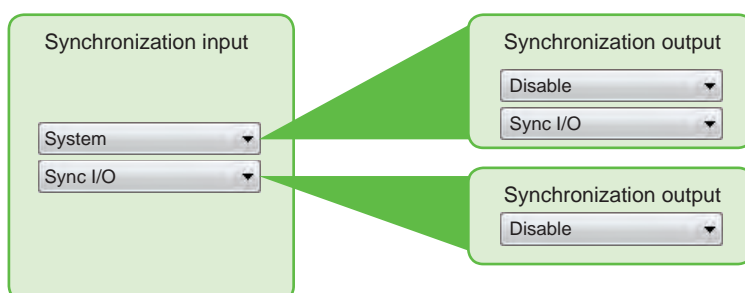

Synchronization options with TRION-TIMING module

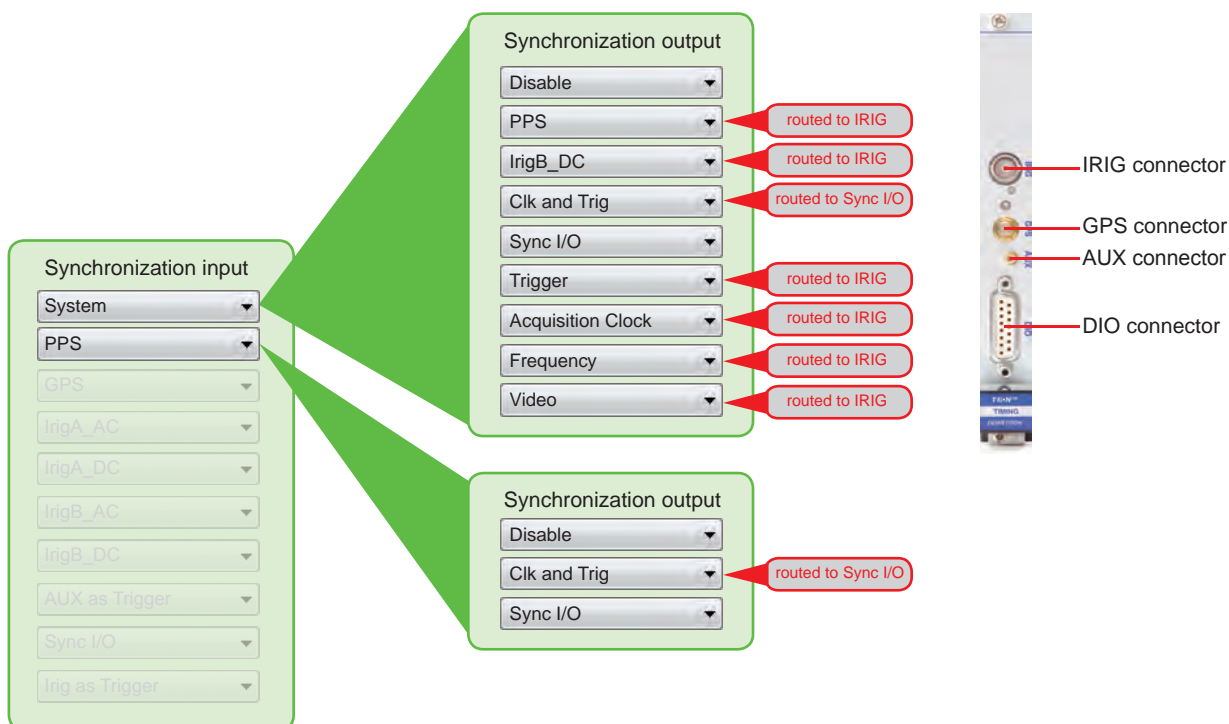

Synchronization of DEWE2

TRION-TIMING module

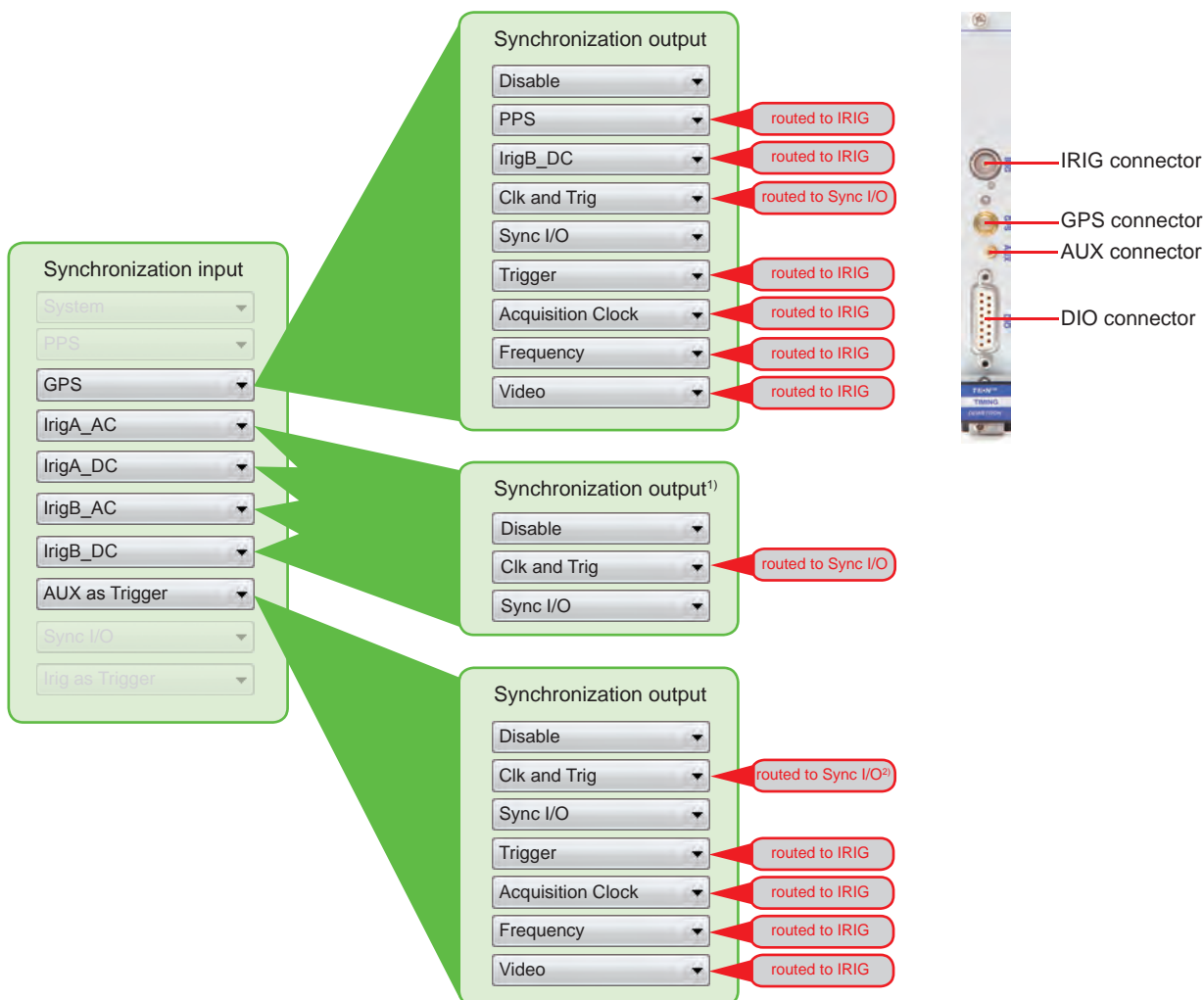

¹⁾ Synchronization output for IrigA (AC/DC) as well as IrigB (AC/DC) are the same.

²⁾ When using 'AUX as Trigger' for synchronization input and 'Clk and Trig' as synchronization output, DEWESoft 7.x displays 'routed to Sync I/O'. It is routed to the **DIO connector** of the **TRION-TIMING module**. **This is an error in DEWESoft 7.x!**

Synchronization of DEWE2

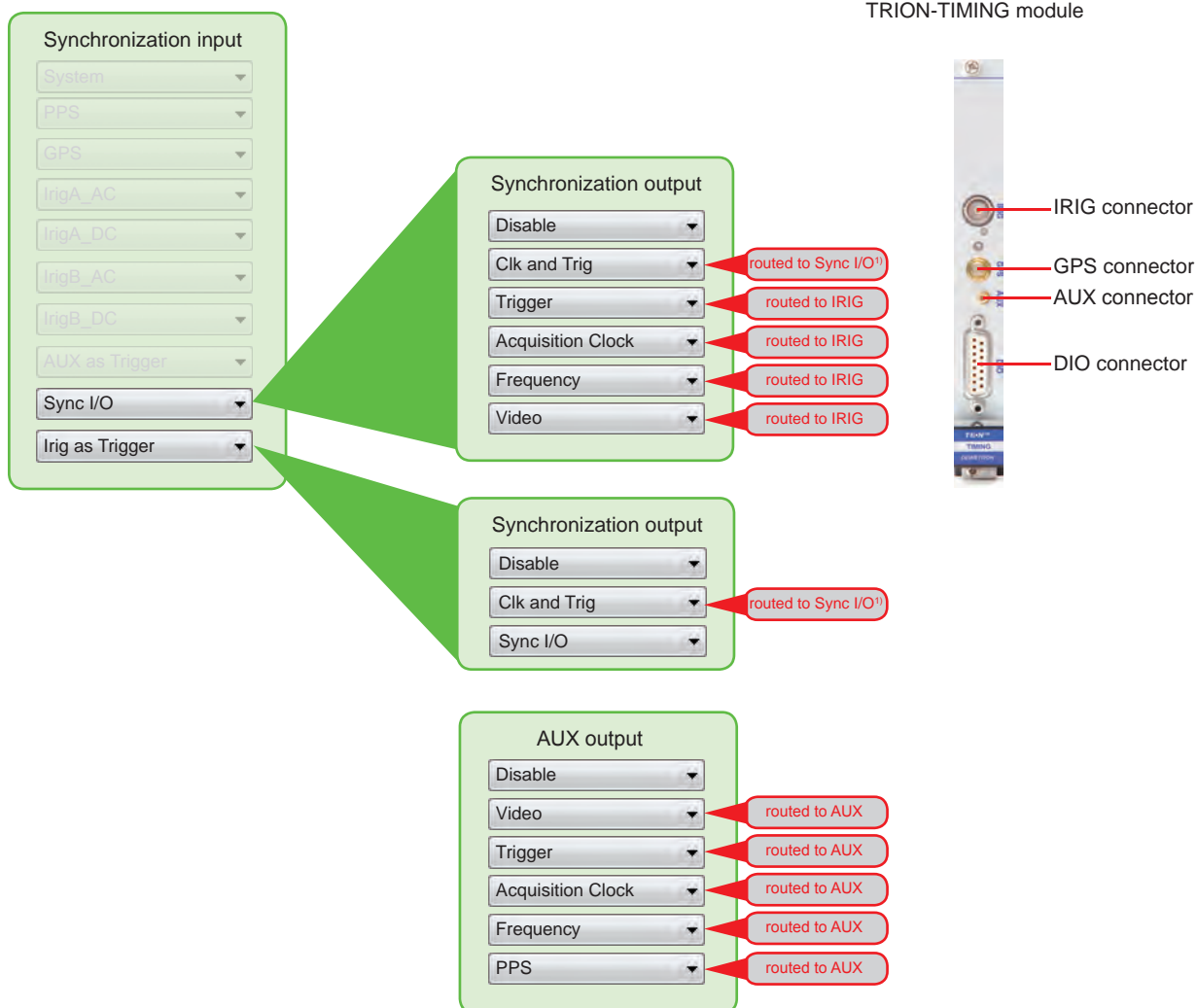

¹⁾ When using 'Sync I/O' or 'Irig as Trigger' for synchronization input and 'Clk and Trig' as synchronization output, DEWESoft 7.x displays 'routed to Sync I/O'. It is routed to the **DIO connector** of the **TRION-TIMING module**. **This is an error in DEWESoft 7.x!**

Synchronization of DEWE2

Synchronization options with TRION-BASE module

TRION-BASE module

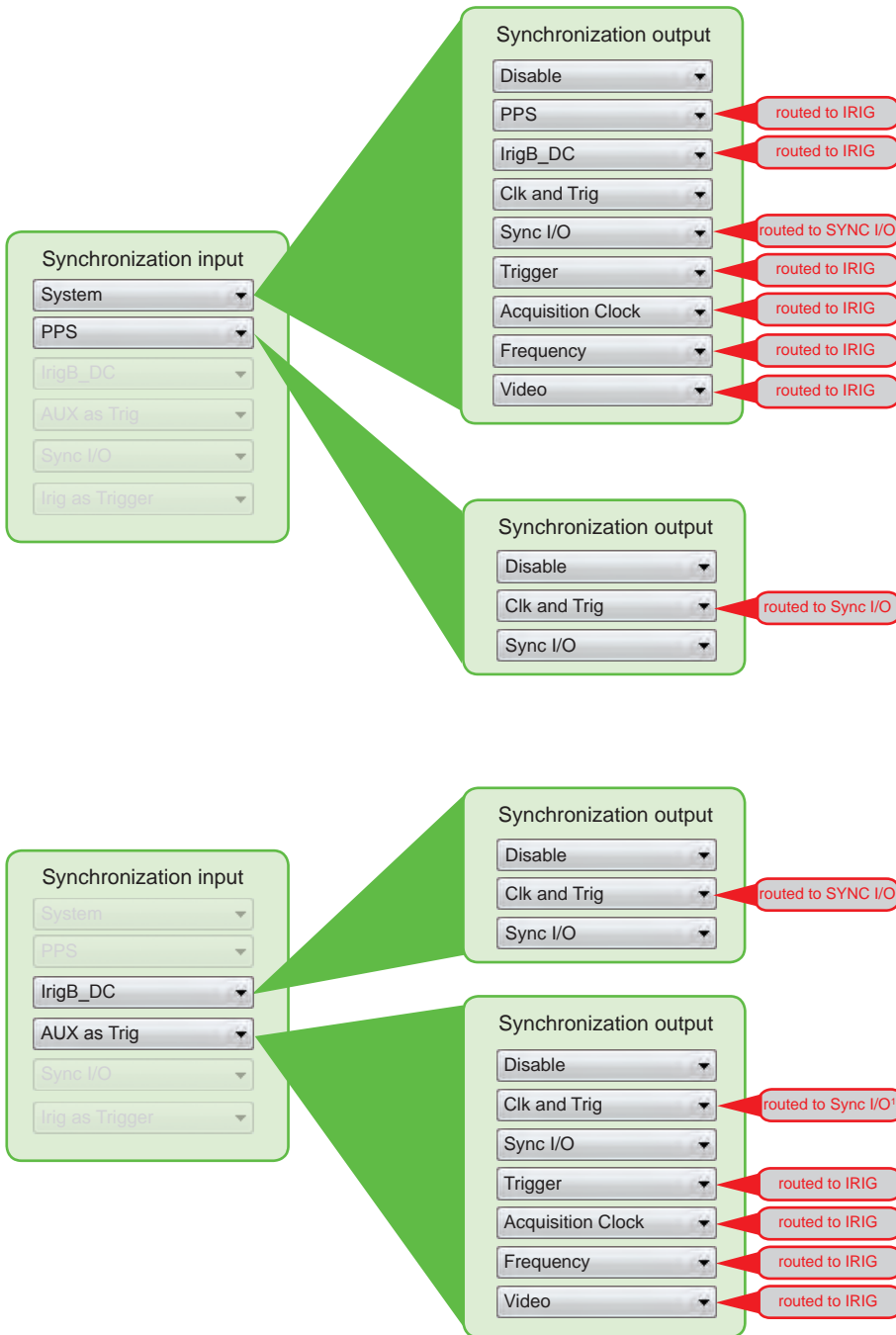
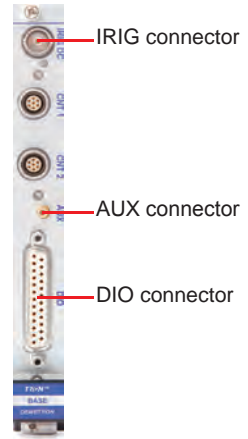

¹⁾ When using 'AUX as Trigger' for synchronization input and 'Clk and Trig' as synchronization output, DEWESoft 7.x displays 'routed to Sync I/O'. It is routed to the **DIO connector** of the **TRION-TIMING module**. This is an error in DEWESoft 7.x!

Synchronization of DEWE2

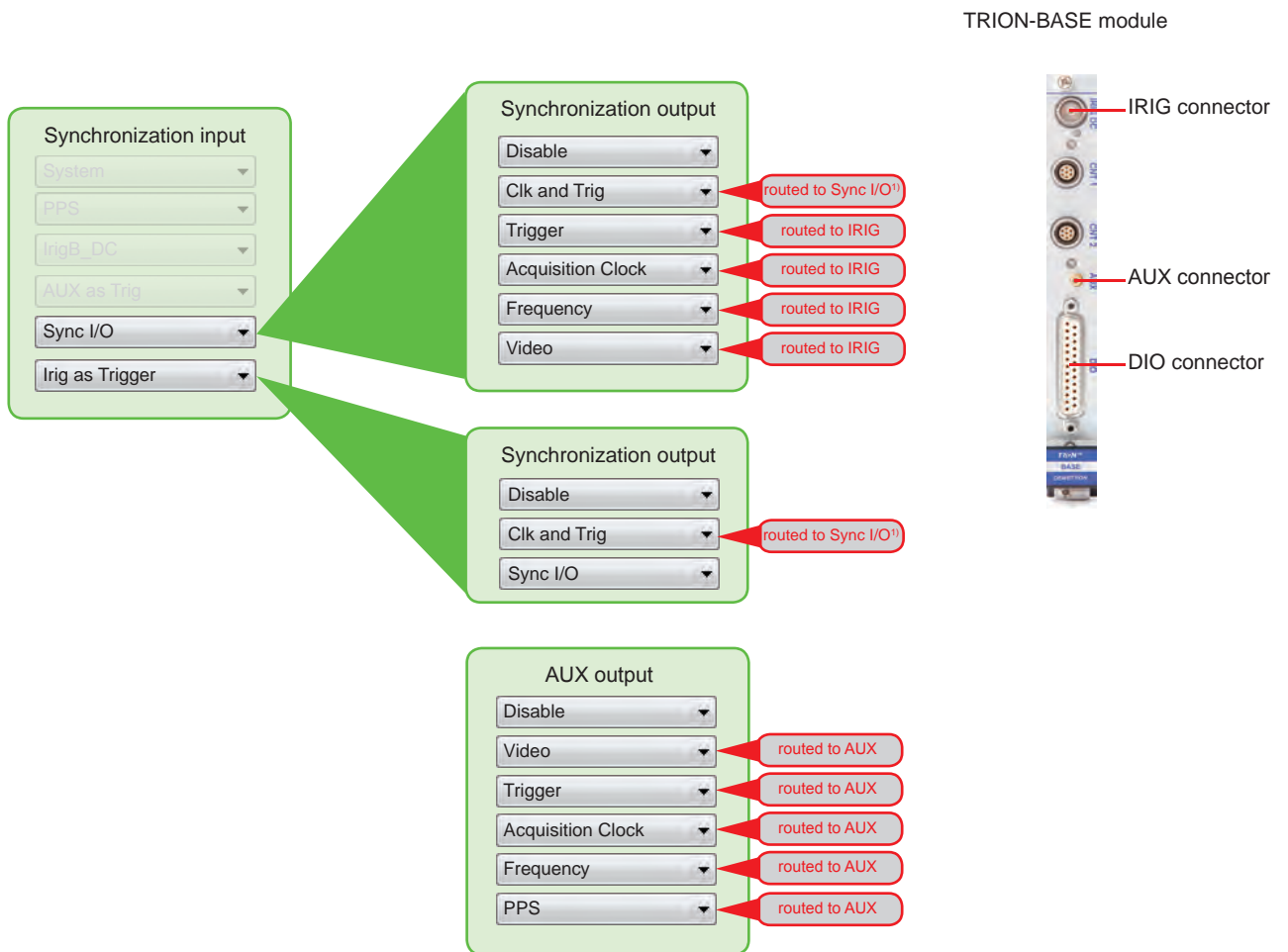

¹⁾ When using 'Sync I/O' or 'Irig as Trigger' for synchronization input and 'Clk and Trig' as synchronization output, DEWESoft 7.x displays 'routed to Sync I/O'. It is routed to the **DIO connector** of the **TRION-TIMING** module. **This is an error in DEWESoft 7.x!**

Synchronization of DEWE2

3.0 Typical synchronization examples

This chapter will demonstrate some typical synchronization examples with DEWE2 devices and corresponding TRION™ modules and configurations. Due to the many variation possibilities only the most common are described in this manual. For more information regarding special synchronization options do not hesitate to contact your local dealer!

2.9.1 Channel expansion with TRION-SYNC-BUS interface and option DW2-LINK-OUT

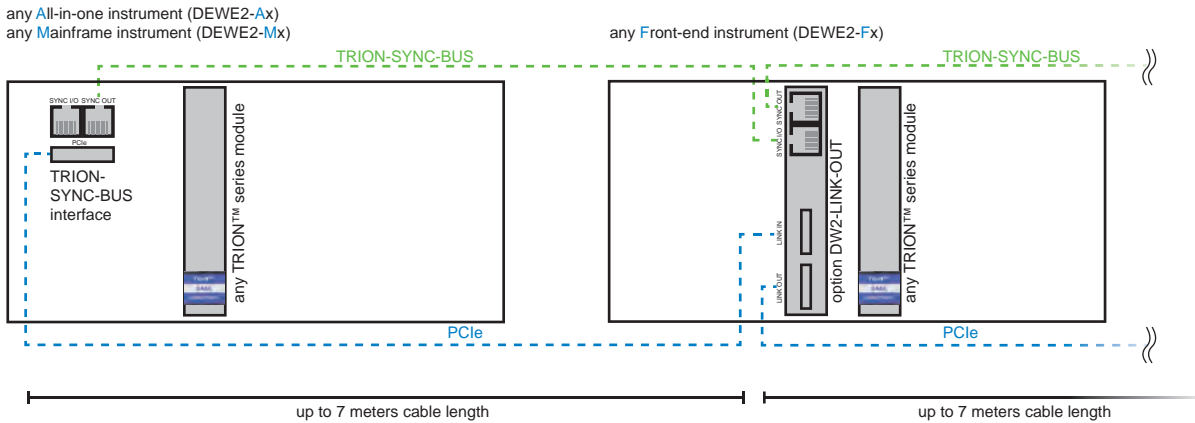

2.9.2 DEWE2-Ax /-Mx with TRION-SYNC-BUS interface

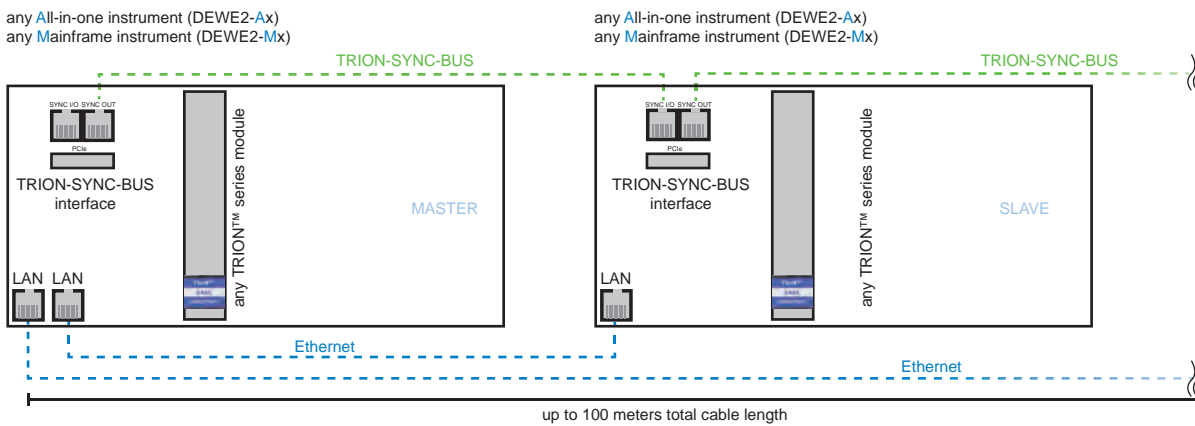

The instruments are connected via standard Ethernet (CATVI) cable or via WLAN, if installed.

Synchronization of DEWE2

2.9.3 DEWE2-Ax /-Mx with TRION-BASE and TRION-TIMING modules

This option requires either a TRION-BASE or TRION-TIMING module in each system.

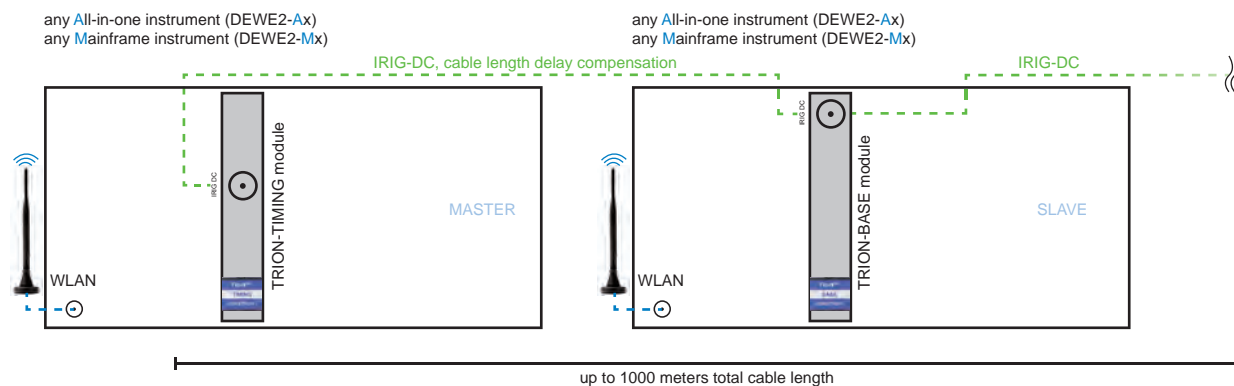

Usually the connection of the instruments is done via WLAN. If no WLAN option is available with your system, the connection is done via ethernet (CATVI) cable.

NOTE: Although the synchronization is realized with IRIG time-code, the maximum cable length must be reduced to ~100 meters when connecting devices via ethernet cable!

- Synchronization options in DEWESoft:

MASTER:

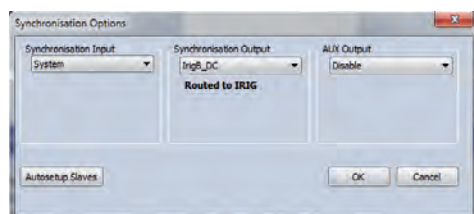

- "System" as synchronization input
- "IrigB_DC" as synchronization output

SLAVE:

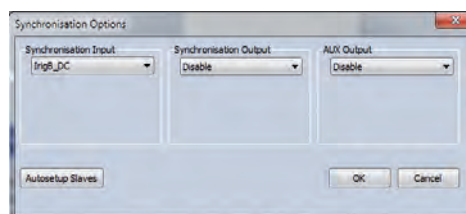

- "IrigB_DC" as synchronization input
- "Disabled" as synchronization output

When choosing "IrigB_DC" as synchronization output at the master/slave system, the IRIG time-code is routed automatically to the BNC connector labeled as "IRIG" on the TRION™ series module.

Synchronization of DEWE2

Notes

CE-Certificate of conformity



Manufacturer:

DEWETRON GmbH

Address:

**Parking 4
8074 Grambach, Austria**

Tel.: +43 316 3070 0

Fax: +43 316 3070 90

e-mail: sales@dewetron.com

http://www.dewetron.com

Name of product:

DEWE2-M13

Kind of product:

Data acquisition instrument

The product meets the regulations of the following EC-directives:

2006/95/EC

"Directive on the approximation of the laws of the Member States relating to electrical equipment designed for use within certain voltage limits."

2004/108/EC

"Directive on the approximation of the laws of the Member States relating to electromagnetic compatibility amended by the directives 89/336/EWG."

The accordance is proved by the observance of the following standards:

L V E M C	Safety	IEC 61010-1:2011 300 V CATII, Pol. Deg. 2	
	Emissions	EN 61000-6-4	EN 55011 Class B
	Immunity	EN 61000-6-2	Group standard

Graz, May 23, 2013

Place / Date of the CE-marking

Ing. Thomas Propst / Manager Total Quality

Notes
