



DEWETRON

▼

PAD-V8-P Module

TECHNICAL REFERENCE MANUAL

▼

WELCOME TO THE WORLD OF DEWETRON!

Congratulations on your new device! It will supply you with accurate, complete and reproducible measurement results for your decision making.

Look forward to the easy handling and the flexible and modular use of your DEWETRON product and draw upon more than 30 years of DEWETRON expertise in measurement engineering.

▼

ISO9001



THE MEASURABLE DIFFERENCE.

Copyright © DEWETRON GmbH

This document contains information which is protected by copyright. All rights are reserved. Reproduction, adaptation, or translation without prior written permission is prohibited, except as allowed under the copyright laws.

All trademarks and registered trademarks are acknowledged to be the property of their owners.

The information contained in this document is subject to change without notice.

DEWETRON GmbH (DEWETRON) shall not be liable for any errors contained in this document. DEWETRON MAKES NO WARRANTIES OF ANY KIND WITH REGARD TO THIS DOCUMENT, WHETHER EXPRESS OR IMPLIED. DEWETRON SPECIFICALLY DISCLAIMS THE IMPLIED WARRANTIES OF MERCHANTABILITY AND FITNESS FOR A PARTICULAR PURPOSE. DEWETRON shall not be liable for any direct, indirect, special, incidental, or consequential damages, whether based on contract, tort, or any other legal theory, in connection with the furnishing of this document or the use of the information in this document.

Warranty Information:

A copy of the specific warranty terms applicable to your DEWETRON product and replacement parts can be obtained from your local sales and service office.

Restricted Rights Legend:

Use austrian law for duplication or disclosure.

DEWETRON GmbH
Parkring 4
8074 Grambach
Austria

Printing History:

Please refer to the page bottom for printing version.

Copyright © DEWETRON GmbH.

This document contains information which is protected by copyright. All rights are reserved. Reproduction, adaptation, or translation without prior written permission is prohibited, except as allowed under the copyright laws.

All trademarks and registered trademarks are acknowledged to be the property of their owners.

▼ Notice

Safety symbols in the manual



Indicates hazardous voltages.

WARNING *Calls attention to a procedure, practice, or condition that could cause bodily injury or death.*

CAUTION *Calls attention to a procedure, practice, or condition that could possibly cause damage to equipment or permanent loss of data.*

WARNINGS

The following general safety precautions must be observed during all phases of operation, service, and repair of this product. Failure to comply with these precautions or with specific warnings elsewhere in this manual violates safety standards of design, manufacture, and intended use of the product. DEWETRON Elektronische Messgeraete Ges.m.b.H. assumes no liability for the customer's failure to comply with these requirements.

All accessories shown in this document are available as option and will not be shipped as standard parts.

Safety instructions for DEWETRON amplifiers

- The DEWETRON data acquisition systems and amplifiers may only be installed by experts.
- Read your manual carefully before operating.
- Observe local laws when using the amplifiers.
- Ground the equipment: For Safety Class 1 equipment (equipment having a protective earth terminal), a non interruptible safety earth ground must be provided from the mains power source to the product input wiring terminals or supplied power cable.
- DO NOT operate the product in an explosive atmosphere or in the presence of flammable gases or fumes.
- DO NOT operate damaged equipment: Whenever it is possible that the safety protection features built into this product have been impaired, either through physical damage, excessive moisture, or any other reason, REMOVE POWER and do not use the product until safe operation can be verified by service-trained personnel. If necessary, return the product to a DEWETRON sales and service office for service and repair to ensure that safety features are maintained.
- Keep away from live circuits: Operating personnel must not remove equipment covers or shields. Procedures involving the removal of covers or shields are for use by service-trained personnel only. Under certain conditions, dangerous voltages may exist even with the equipment switched off. To avoid dangerous electrical shock, DO NOT perform procedures involving cover or shield removal unless you are qualified to do so.
- No modifications are allowed at the amplifiers.
- DO NOT service or adjust alone. Do not attempt internal service or adjustment unless another person, capable of rendering first aid and resuscitation, is present.
- DO NOT substitute parts or modify equipment: Because of the danger of introducing additional hazards, do not install substitute parts or perform any unauthorized modification to the product. Return the product to a DEWETRON sales and service office for service and repair to ensure that safety features are maintained.
- DO NOT touch internal wiring!
- DO NOT use higher supply voltage than specified!
- Use only original plugs and cables for harnessing.
- Safety of the operator and the unit depend on following these rules.

▼ Support

For any support please contact your local distributor first or DEWETRON directly.

For Asia and Europe, please contact:

DEWETRON GmbH
Parkring 4
8074 Grambach
AUSTRIA
Tel.: +43 316 3070
Fax: +43 316 307090
Email: support@dewetron.com
Web: <http://www.dewetron.com>

The telephone hotline is available Monday to Friday between 08:00 and 12:00 CET (GMT -1:00) and Monday to Thursday between 13:00 and 17:00 CET.

For the Americas, please contact:

DEWETRON, Inc.
2850 South County Trail, Unit 1
East Greenwich, RI 02818
U.S.A.
Tel.: +1 401 284 3750
Toll-free: +1 866 598 3393
Fax: +1 401 284 3755
Email: us.support@dewetron.com
Web: <http://www.dewetron.us>

The telephone hotline is available Monday to Friday between 08:00 and 17:00 GST (GMT +5:00)

General Module Information

Calibration information

All DEWETRON modules are calibrated at 25 °C after a warmup time of 30 minutes and meet their specifications when leaving the factory.

The time interval for recalibration depends on environmental conditions. Typically, the calibration should be checked once a year.

Calibration certificates are available from DEWETRON as an option. DEWETRON offers two types:

- ISO traceable DEWETRON certificate
- Calibration certificate according to ÖKD (equivalent to DKD)

This manual contains no calibration information. For self calibration, there is a separate calibration kit for the DAQ series modules available. The CAL-KIT contains the required cables, software and instructions.

General module specifications

Module dimensions: 20 x 65 x 105 mm (0.79 x 2.56 x 4.13 in.)
(W x H x D without front cover and connectors)

Frontcover: 20 x 87 x 2 mm (0.79 x 3.43 x 0.08 in.)
(W x H x D without connector)

Environmental:

Temp. range storage: -30 °C to +85 °C (-22 °F to 185 °F)

Temp. range operating: -5 °C to +60 °C (23 °F to 140 °F)

Relative humidity

(MIL202): 0 to 95 % at 60 °C, non-condensing (unless otherwise noticed)

RFI susceptibility: ±0.5 % span error at 400 MHz, 5 W, 3 m

All specifications within this manual are valid at 25 °C!

All modules are produced according ISO9001 and ISO14001.

Module connectors

Frontpanel connector: Accessable to the user. The connector type and pin assignment varies from module to module. Detailed pin assignment of each module is shown in the appropriate module description.

Rear connector: 9-pin male SUB-D, interface to the DEWE-System, not accessible to the user.



HSI/DAQx and PAD module
rear view

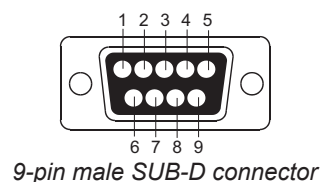

Interface pin assignment:

- 1 Module output (± 5 V)
- 2 RS-485 (A)
- 3 RS-485 (B)
- 4 GND
- 5 +9 V power supply
- 6 +12 V power / sensor supply
- 7 Module input (from D/A converter of the A/D board)¹⁾
- 8 reserved
- 9 -9 V power supply

¹⁾ Triggerout at DAQP-FREQ-A

General Module Information

RS-232/485 interface

HSI/DAQP modules can be configured via RS-485 interface, PAD modules require this interface for all data transfers.

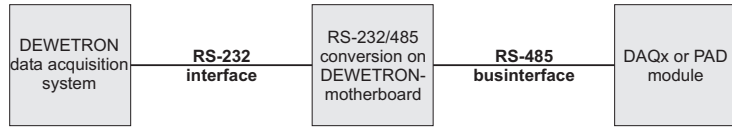

For all DEWETRON systems, an internal RS-232/485 converter is available (standard with DEWE-800, -2000, -2500, -3000, -4000, -5000 series systems). This converter allows communication with HSI/DAQP and PAD modules.

To communicate with the modules, the RS-232 interface has to be set to the following parameters:

baud rate:	9600 bps
data bits:	8
parity:	no parity
stop bits:	1
handshake:	not required

HSI/DAQP module configuration

1. Push button selection

All ranges and filters can be selected directly by pressing the push buttons on the module. Approx. 15 sec. after changing range and / or filter, the range and filter information is stored in an EEPROM. This procedure increases the lifetime of the EEPROM.

The current input range setting is shown all the time by LED. To change the range just press **RANGE** button a few times until the required range is displayed.

To see the current filter setting just press the **FILTER** button once. The corresponding LED is flashing for approx. 3 seconds. Within this time, the filter can be selected by pressing the **FILTER** button again. Approx. 3 seconds after the last key activity, the information will be stored, the LED stops flashing and shows the input range again.

CAUTION: Power loss during this time leaves the module in the former settings.

2. RS-232/485 programming

All ranges and filters can also be selected via RS-232/485 interface. All new DEWE-800, -2000, -2500, -3000, -4000, -5000 series systems are prepared as a standard to work with HSI/DAQP modules.

The easiest way to change the configuration is to use the DEWEConfig software, which comes as a standard with the DEWETRON data acquisition system.

Detailed information about HSI/DAQP modules programming for customer applications is available in the *DEWE-Modules Programmers Reference Manual*.

CAUTION: All range and filter changes which are done via RS-232/485 interface are not stored in the EEPROM of the HSI/DAQP modules! You have to store this information in a separat initialisation file to keep settings information for next system start!

PAD module communication

All PAD modules are only working through the RS-232/485 interface. All new DEWE-800, -2000, -2500, -3000, -4000, -5000 series systems are prepared as a standard to work with PAD modules. The easiest way to change the configuration is to use the DEWEConfig software, which comes as a standard with the DEWETRON data acquisition system.

Detailed information about PAD modules programming for customer applications is available in the *DEWE-Modules Programmers Reference Manual*.

8 channel voltage amplifier

- Intelligent amplifier with integrated 24-bit A/D conversion
- 8 differential voltage input channels
- Signal connection via 25-pin SUB-D connector



Module specifications

PAD-V8-P		
	Revision 5.04 and lower	Revision 6.00 and higher
Input channels	8 differential input channels	
Input signals	±100 mV, ±150 mV, ±500 mV, ±1 V, ±2.5 V, ±5 V, ±10 V, ±50 V, -0.15 to +1.5 V	
Voltage	With external shunt resistor	
Current	10 µV for all ranges	
Resolution	10 µV for all ranges	
Sampling rate	Max. 6 Hz per channel	Max. 12 Hz per channel
Readout speed	Typ. 50 ch/sec.*	Typ. 80 ch/sec.*
DC accuracy	±0.03 % of reading ±900 µV	
Max. gain drift	20 ppm /°C	
Max. offset drift	20 ppm of range /°C	
Bandwidth (-3 dB)	3 Hz (±1.5 dB @ f ₀)	6 Hz (±1.5 dB @ f ₀)
Isolation voltage	350 VDC (channel to channel and input to output)	
Overvoltage protection	150 V _{DC}	
Common mode voltage	350 V _{DC} / 250 V _{AC} @ 50 Hz	
NMR	120 dB @ 50/60 Hz	
CMRR	140 dB @ DC, 120 dB @ 50 Hz	
RS-485 interface	Yes	
Interface speed	9600 bps (2400 to 115200)	
Power supply voltage	±9 V _{DC} (±10 %)	
Power consumption	Typical 0.6 W	

* Depending on system and number of channels

PAD-V8-P

Block diagram

The base block diagram of the PAD-V8-P gives an idea of the internal structure.

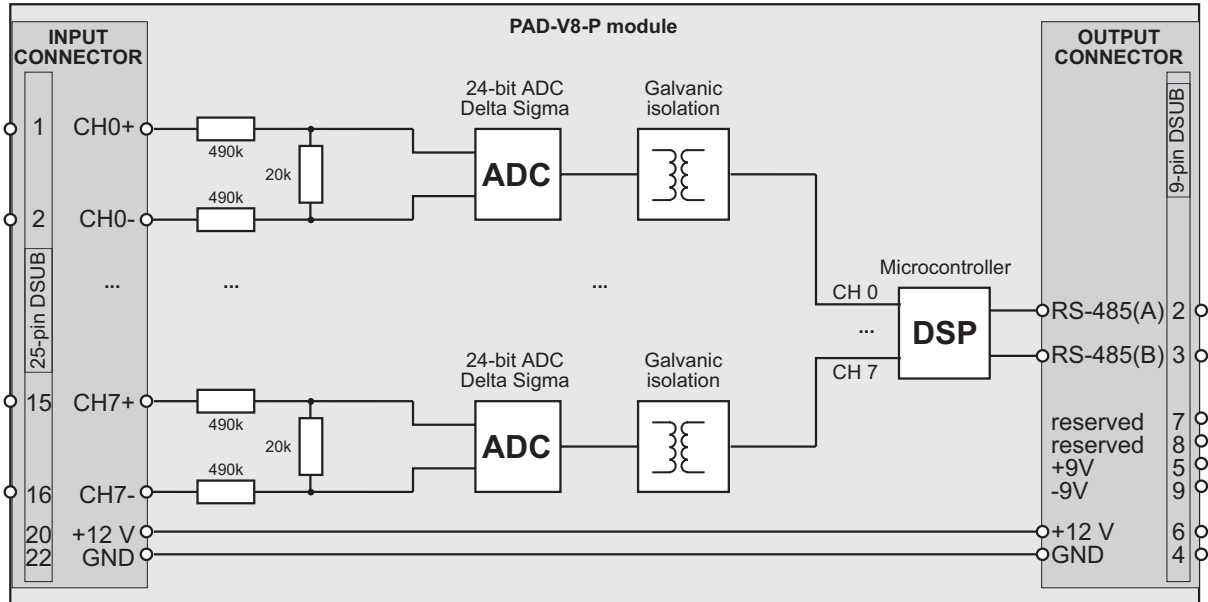

Signal connection

PAD-V8-P module

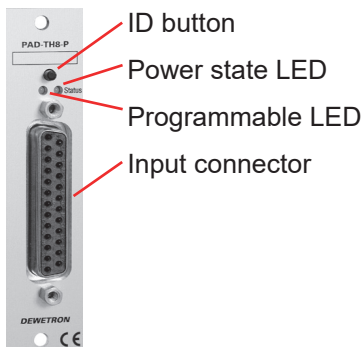

Input connector:

1 Channel 0 (+)	13 Channel 6 (+)
2 Channel 0 (-)	14 Channel 6 (-)
3 Channel 1 (+)	15 Channel 7 (+)
4 Channel 1 (-)	16 Channel 7 (-)
5 Channel 2 (+)	17 Digital input 1*
6 Channel 2 (-)	18 Digital input 2*
7 Channel 3 (+)	19 Digital input 3*
8 Channel 3 (-)	20 +12 V _{DC}
9 Channel 4 (+)	21 Reset / Digital input 4*
10 Channel 4 (-)	22 GND
11 Channel 5 (+)	23 Reserved
12 Channel 5 (-)	24 Reserved
	25 Reserved

ID button:	Used to define module address via software
Power state LED:	Flashing when data transfer is active
Programmable LED:	Free programmable state LED (on = standard; off or 1 Hz flashing programmable)

Reset procedure for firmware 1.14 and lower:

- Connect Pin 21 (Reset) to pin 22 (GND) on the DSUB-25 connector.
- Press the ID button during powering on the module.

Reset procedure for firmware 2.00 and higher:

- Press the ID button during powering on the module and keep it pressed for at least 3 more seconds.

Default values:

- Baud rate: 9600 Bps
- Address: 00h (equals a cleared module in DEWESoft)
- Data Format: engineering unit, no checksum

*) no DEWESoft support.

Connection options for PAD-V8-P module

PAD-OPT2

25-pin SUB-D connector with screw terminal
(not included as a standard with module).

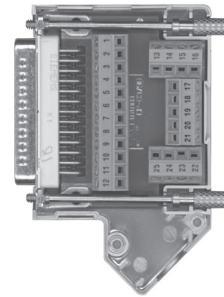

PAD-CB8-xx

Connection box with banana connectors or BNC for all 8 channels, cable length approx. 1 m
(not included as a standard with module).



Dimensions CB8-B

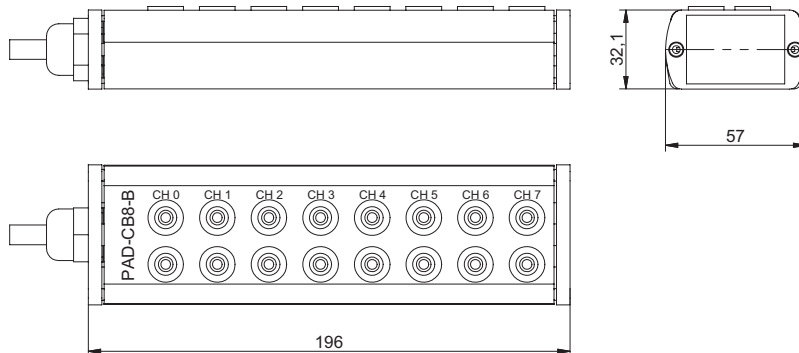

Dimensions CB8-BNC

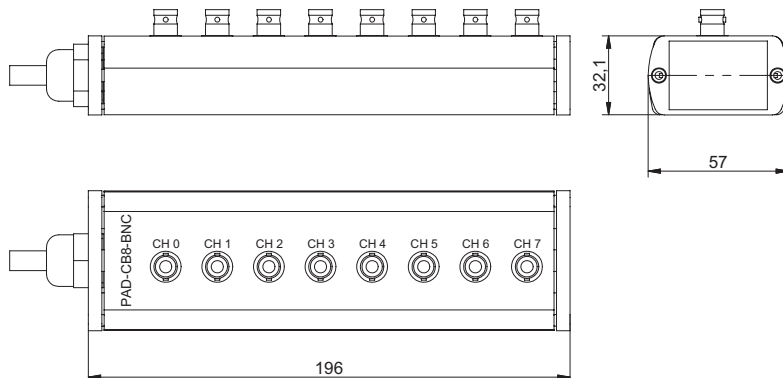

(Dimensions in mm; 1 inch = 25.4 mm)

▼
PAD-V8-P

Notes

CE-Certificate of conformity



Manufacturer:

DEWETRON GmbH

Address:

**Parking 4
8074 Grambach, Austria**

Tel.: +43 316 3070 0

Fax: +43 316 3070 90

e-mail: sales@dewetron.com

http://www.dewetron.com

Name of product:

DEWE-MODULES

Kind of product:

Signal conditioning modules

The product meets the regulations of the following EC-directives:

73/23/EEC

"Directive on the approximation of the laws of the Member States relating to electrical equipment designed for use within certain voltage limits amended by the directive 93/68/EEC"

89/336/EEC

"Directive on the approximation of the laws of the Member States relating to electromagnetic compatibility amended by the directives 91/263/EEC, 92/31/EEC, 93/68/EEC and 93/97/EEC"

The accordance is proved by the observance of the following standards:

L V E M C	Safety	IEC/EN 61010-1:1992/93 IEC 61010-1:1992/300 V CATIII Pol. D. 2 IEC/EN 61010-2-031 IEC 1010-2-031
	Emissions	EN 61000-6-4 EN 55011 Class B
	Immunity	EN 61000-6-2 Group standard

Graz, April 28, 2010

Place / Date of the CE-marking

Dipl.-Ing. Roland Jeutter / Managing director

▼
Notes
