



DEWETRON



DEWE3-A4

TECHNICAL REFERENCE



ISO 9001

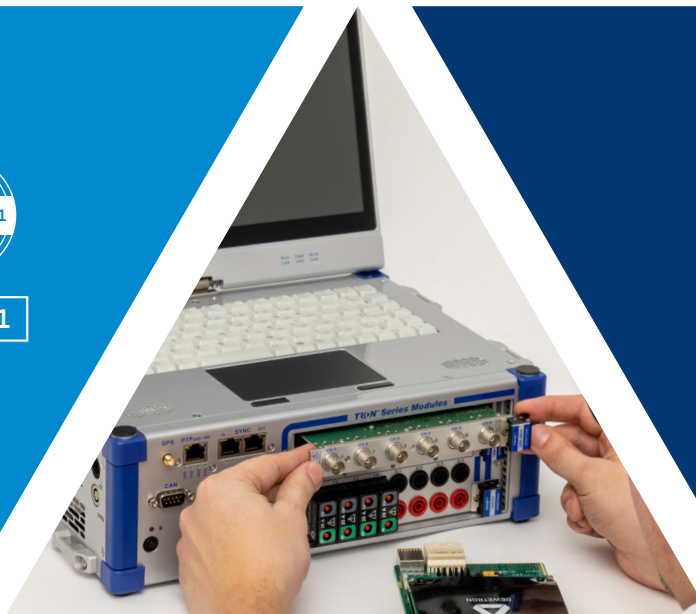

Copyright © DEWETRON GmbH

This document contains information which is protected by copyright. All rights are reserved. Reproduction, adaptation, or translation without prior written permission is prohibited, except as allowed under the copyright laws.

All trademarks and registered trademarks are acknowledged to be the property of their owners.

Preface

Thank you!

Thank you very much for your investment in DEWETRON's unique data acquisition systems. These are top-quality instruments which are designed to provide you years of reliable service. This guide has been prepared to help you get the most from your investment, starting from the day you take it out of the box, and extending for years into the future.

This guide includes important startup notes, as well as safety notes and information about keeping your DEWETRON system in good working condition over time. However, this manual cannot and is not intended to replace adequate training.

This documentation contains operating as well as safety and care instructions that must be observed by the user. Faultless operation can only be guaranteed by observing these instructions.

Intended use

A DEWETRON DEWE3-A4 is an all-in-one instrument and the high-speed solution of the popular, previous generation DEWE2-A4. The instrument offers 4 slots for user exchangeable TRION/TRION3 series modules.

To achieve the high performance of up to 5 MS/s¹⁾ simultaneous sampling rate, use the new TRION3 series modules.

Still, the DEWE3 series instruments are downward compatible and can also be equipped with the common TRION modules.

1) By using the TRION3-1810M-POWER module even 10 MS/s can be achieved.

TABLE OF CONTENTS

Preface	3		
Thank you!.....	3		
Intended use.....	3		
Safety	6		
Safety instructions	6		
General safety instructions.....	6		
Electrical safety instructions.....	7		
Ambient safety notices.....	7		
Safety notices during operation.....	8		
Standards and norms	8		
Typographic conventions	8		
Safety and warning notices.....	8		
Notices.....	9		
Symbols.....	9		
General information	10		
Environmental considerations	10		
Problematic network stacks	10		
Warranty information	10		
Legal information	10		
Restricted rights legend.....	10		
Legal disclaimer.....	10		
Printing history	11		
Main system	12		
Key facts	12		
System specifications	12		
Dimensions*	13		
Block diagram	14		
Connections and ports	15		
Power supply	16		
Power supply output for accessories.....	16		
Power supply input connector.....	16		
<i>Internal DC power supply</i>	16		
<i>External AC/DC power supply</i>	16		
<i>DW2-PS-DC-BUFFER (option)</i>	16		
<i>DW2-UPS-250-DC (option)</i>	17		
Power on/off push button and status LED.....	17		
<i>SSD activity LED</i>	17		
<i>Power on/off push button</i>	17		
<i>Buzzer</i>	17		
Sync and digital interfaces	18		
Overview.....	18		
Active sync LEDs.....	18		
TRION SYNC-BUS.....	18		
Digital I/O connector.....	19		
<i>AUX terminal</i>	20		
<i>PPS terminal</i>	20		
<i>Counter and digital I/O</i>	21		
<i>Advanced counter</i>	21		
GPS (optional).....	21		
<i>DEWE2/3 clock engine</i>	22		
<i>Optional accessory</i>	23		
PTP/IEEE 1588 (optional).....	23		
CAN connector (optional).....	24		
<i>Connection</i>	24		
<i>High-speed CAN</i>	24		
<i>Termination</i>	25		
<i>Optional accessory</i>	25		
USB 3.2 interface connectors	25		
Display port & HDMI connectors	25		
Chassis terminal	26		
Gigabit Ethernet LAN connectors	26		
EPAD2 connector	26		
TRION/TRION3 series module slots	26		
Touchpad	26		
Touchscreen	27		
Tap.....	27		
Pinch or stretch.....	27		
Tap and hold.....	27		
Swipe and drag.....	27		
SSD drive bay	28		
Option SSD-256G-1T-EL.....	28		
Labels	28		
Nameplate.....	28		
Options label.....	28		
Options and accessoires	28		

▼

TABLE OF CONTENTS

Working with the system	30	Letter of volatility	47
Hardware	30	Volatile memory	47
DEWE3/TRION(3) hardware compatibility	30	Non-volatile memory	47
TRION series modules overview	30		
<i>Analog modules</i>	30		
<i>Digital modules</i>	31		
<i>Power modules</i>	32		
<i>Analog output modules</i>	32		
Installing a TRION module	33		
Cooling considerations	34		
Software	34		
Starting OXYGEN.....	34		
Connect and set up signals and sensors.....	35		
Changing channel settings.....	36		
Design the measurement screen	36		
Record	37		
Open datafile and export	38		
Synchronization	40		
Channel expansion with TRIONet	40		
Network with multiple systems.....	41		
Absolute time synchronization.....	41		
PTP sync / IRIG sync	41		
GPS sync.....	42		
Maintenance and service	43		
Service interval	43		
Cleaning the system	43		
Cleaning the filter pad	44		
<i>Requirements</i>	44		
<i>Procedure</i>	44		
System recovery	45		
Updates	45		
Windows and antivirus/security software	45		
Software updates	45		
Training	45		
Calibration	45		
Support	46		
Service and repairs	46		

SAFETY

Safety

Safety instructions

The following section contains warning and safety instructions that must be observed by the user. Faultless operation can only be guaranteed if these instructions are observed.

General safety instructions

- ▶ Use this system under the terms of the specifications only to avoid any possible danger. If the unit is used in a manner not specified by the manufacturer the protection can be impaired.
- ▶ Maintenance is to be executed by qualified staff only.
- ▶ DO NOT use the system if equipment covers or shields are removed. If you assume the system is damaged, have it examined by authorized personnel only.
- ▶ Any other use than described above may damage your system and is attended with dangers such as short-circuits, fire or electric shocks.
- ▶ The whole system must not be changed, rebuilt or opened (except for changing TRION modules).
- ▶ Reinstall filler panels of unused TRION slots to guarantee proper cooling of the installed modules. The warranty is void if the modules overheat due to missing filler panels.
- ▶ If you assume a more riskless use is not provided anymore, the system has to be rendered inoperative and should be protected against inadvertent operation. It is assumed that a more riskless operation is not possible anymore, if
 - the system is damaged obviously or causes strange noises.
 - the system does not work anymore.
 - the system has been exposed to long storage in adverse environmental.
 - the system has been exposed to heavy shipment strain.
- ▶ The warranty is void if damages caused by disregarding this manual. For consequential damages NO liability will be assumed.
- ▶ The warranty is void if damages to property or persons caused by improper use or disregarding the safety instructions.
- ▶ Unauthorized changing or rebuilding the system is prohibited due to safety and permission reasons (CE). Exception: changing DAQP/PAD/HSI/TRION/TRION3 modules.
- ▶ Prevent using metal bare wires as there is a risk of short-circuit and fire hazard.
- ▶ DO NOT use the system before, during or shortly after a thunderstorm (risk of lightning and high energy overvoltage). An advanced range of application under certain conditions is allowed with therefore designed products only. For details refer to the specifications.
- ▶ Make sure that your hands, shoes, clothes and as well as the floor, the system or measuring leads, integrated circuits etc. are dry.
- ▶ Use measurement leads or measurement accessories aligned to the specification of the system only. Fire hazard in case of overload.
- ▶ Do not disassemble the system. There is a high risk of getting a perilous electric shock. Capacitors still might be charged, even the system has been removed from the power supply.
- ▶ The measuring systems are not designed for use at humans and animals.
- ▶ Contact a professional if you have doubts about the method of operation, safety or the connection of the system.
- ▶ Handle the product with care. Shocks, hits and dropping it even from an already lower level may damage your system.
- ▶ Also consider the detailed technical reference manual as well as the security advices of the connected systems.

Electrical safety instructions

- ▶ With this product, only use the power cable delivered or defined for the host country.
- ▶ DO NOT connect or disconnect sensors, probes or test leads, as these parts are connected to a voltage supply unit.
- ▶ The system is grounded via a protective conductor in the power supply cord. To avoid electric shocks, the protective conductor has to be connected with the ground of the power network. Before connecting the input or output connectors of the system, make sure that there is a proper grounding to guarantee potential free usage. For countries, in which there is no proper grounding, refer to your local legally safety regulations for safety use.
- ▶ DC systems: Every DC system has a grounding connected to the chassis (black safety banana plug).
- ▶ Note the characteristics and indicators on the system to avoid fire or electric shocks. Before connecting the system, carefully read and understand the corresponding specifications in the product manual.
- ▶ The inputs are not, unless otherwise noted (CATx identification), for connecting to the main circuits of category II, III and IV. The measurement category can be adjusted depending on module configuration.
- ▶ The power cord or the main power switch separates the system from the power supply. Do not block the power cord or main switch, since it has to be accessible for the users.
- ▶ Any direct voltage output is protected with a fuse against short-circuits and reverse-polarity, but is NOT galvanically isolated (except it is explicit marked on the system).
- ▶ Supply overvoltage category is II.
- ▶ The system must be connected and operated to an earthed wall socket at the AC mains power supply only (except for DC systems).
- ▶ DO NOT touch any exposed connectors or components if they are live wired. The use of metal bare wires is not allowed. There is a risk of short-circuits and fire hazard.
- ▶ The assembly of the system is equivalent to protection class I. For power supply, only the correct power socket of the public power supply must be used, except the system is DC powered.
- ▶ Be careful with voltages >25 VAC or >35 VDC. These voltages are already high enough in order to get a perilous electric shock by touching the wiring.
- ▶ Unless otherwise stated, the maximum input voltage for measuring cards is 70 VDC and 46.7 V_{PEAK}.
- ▶ The electrical installations and equipments in industrial facilities must be observed by the security regulations and insurance institutions.

Ambient safety notices

- ▶ This product is intended for use in industrial locations. As a result, this product may cause interference if used in residential areas. Such use must be avoided unless the user takes special measures to reduce electromagnetic emissions to prevent interferences to the reception of radio and television broadcasts.
- ▶ Do not switch on the system after transporting it from a cold into a warm room and vice versa. The thereby created condensation may damage your system. Acclimatise the system unpowered to room temperature.
- ▶ Any use in wet rooms, outdoors or in adverse environmental condition is not allowed. Adverse environmental conditions are:
 - Moisture or high humidity
 - Dust, flammable gases, fumes or dissolver
 - Thunderstorm or thunderstorm conditions (except assembly PNA)
 - Electrostatic fields etc.
- ▶ DO NOT use the system in rooms with flammable gases, fumes or dust or in adverse environmental conditions.
- ▶ Direct exposure of any DEWETRON product to strong sunlight or other heat radiation shall be prevented, as this could excessively heat up the product and lead to permanent damage of the product.
- ▶ The use of the measuring system in schools and other training facilities must be observed by skilled personnel.

SAFETY

Safety notices during operation

- ▶ During the use of the system, it might be possible to access another parts of a more comprehensive system. Read and follow the safety instructions provided in the manuals of all other components regarding warning and security advices for using the system.
- ▶ The product heats during operation. Make sure there is adequate ventilation. Ventilation slots must not covered. Only fuses of the specified type and nominal current may be used. The use of patched fuses is prohibited.

Standards and norms

This product has left the factory in safety-related flawless and proper condition. In order to maintain this condition and guarantee safety use, the user has to consider the security advices and warnings in this manual.

EN 61326-3-1:2008

IEC 61326-1 applies to this part of IEC 61326 but is limited to systems and equipment for industrial applications intended to perform safety functions as defined in IEC 61508 with SIL 1-3.

The electromagnetic environments encompassed by this product family standard are industrial, both indoor and outdoor, as described for industrial locations in IEC 61000-6-2 or defined in 3.7 of IEC 61326-1.

Equipment and systems intended for use in other electromagnetic environments, for example, in the process industry or in environments with potentially explosive atmospheres, are excluded from the scope of this product family standard, IEC 61326-3-1.

Devices and systems according to IEC 61508 or IEC 61511 which are considered as “operationally welltried”, are excluded from the scope of IEC 61326-3-1.

Fire-alarm and safety-alarm systems, intended for protection of buildings, are excluded from the scope of IEC 61326-3-1.

Typographic conventions

Safety and warning notices

WARNING



Indicates a hazardous situation that, if not avoided, could result in death or serious injury.

CAUTION



Indicates a hazardous situation that, if not avoided, could result in minor or moderate injury.

Notices

NOTICE

This text indicates situations or operation errors which could result in property damage or data loss.

INFORMATION

This text indicates important information or operating instructions. Not observing these instructions could inhibit or impede you from successfully completing the tasks described in this documentation.

Symbols



Denotes a warning that alerts you to take precautions to avoid injury. When this symbol is shown on the product, refer to the technical reference manual (ISO 7000-4034; 2004-01).



Indicates hazardous voltages.



Observe precautions for handling electrostatic sensitive devices.



Indicates the chassis terminal (IEC 60417-5020; 2002-10).



Direct current (IEC 60417-5031; 2002-10)



Alternate current (IEC 60417-5032; 2002-10)



Both direct and alternating current (IEC 60417-5033; 2002-10)



Three-phase alternating current (IEC 60417-5032-1; 2002-10)



Protective conductor terminal (IEC 60417-5019; 2006-08)



Equipment protected throughout by double insulation or reinforced insulation (IEC 60417-5172; 2003-02)



On (power) (IEC 60417-5007; 2002-10)



Off (power) (IEC 60417-5008; 2002-10)

GENERAL INFORMATION

General information

Environmental considerations

The following information refers to the environmental impact of the product and the product end-of-life handling. Observe the following guidelines when recycling a DEWETRON system:

▶ System and components recycling



The production of these components has required the extraction and use of natural resources. The substances contained in the system could be harmful to your health and to the environment if the system is improperly handled at its end of life. Recycle this product in an appropriate way to avoid an unnecessary pollution of the environment and to keep natural resources.

This symbol indicates that this system complies with the European Union's requirements according to Directive 2002/96/EC on Waste of Electrical and Electronic Equipment (WEEE). Further information about recycling can be found on the DEWETRON website (www.dewetron.com).

▶ Restriction of hazardous substances

This product has been classified as Monitoring and Control equipment, and is outside the scope of the 2011/65/EU RoHS Directive. This product is known to contain lead.

Problematic network stacks

Often intrusive IT software or network processes can interfere with the primary function of the DEWETRON system: to record data. Therefore we recommend strongly against the installation of IT/MIS software and running their processes on any DEWETRON data acquisition system, and cannot guarantee the performance of our systems if they are so configured.

Warranty information

A copy of the specific warranty terms applicable to your DEWETRON product and replacement parts can be obtained from your local sales and service office.

Legal information

Restricted rights legend

Use Austrian law for duplication or disclosure.

DEWETRON GmbH
Parking 4
8074 Grambach
Austria

TRION and OXYGEN are trademarks of DEWETRON GmbH.

Any other trademarks and registered trademarks are acknowledged to be the property of their owners.

Legal disclaimer

The information contained in this document is subject to change without notice.

DEWETRON GmbH (DEWETRON) shall not be liable for any errors contained in this document.

DEWETRON MAKES NO WARRANTIES OF ANY KIND WITH REGARD TO THIS DOCUMENT, WHETHER EXPRESS OR IMPLIED. DEWETRON SPECIFICALLY DISCLAIMS THE IMPLIED WARRANTIES OF MERCHANTABILITY AND FITNESS FOR A

GENERAL INFORMATION

PARTICULAR PURPOSE. DEWETRON shall not be liable for any direct, indirect, special, incidental, or consequential damages, whether based on contract, tort, or any other legal theory, in connection with the furnishing of this document or the use of the information in this document.

Printing history

Refer to the page bottom for printing version.

Copyright © DEWETRON GmbH

This document contains information which is protected by copyright. All rights are reserved. Reproduction, adaptation, or translation without prior written permission is prohibited, except as allowed under the copyright laws.

MAIN SYSTEM

Main system

Key facts

- ▶ Portable all-in-one data acquisition system
- ▶ Rugged industrial design
- ▶ 4 slots for TRION/TRION3 acquisition series modules
- ▶ 13.3" wide-screen multi-touch full HD display
- ▶ Up to 32 analog high-speed inputs
- ▶ Optional internal buffer battery for <5 minutes
- ▶ Local data storage or data transfer via Ethernet

System specifications

DEWE3-A4	
Input channels	Up to 32 analog high-speed inputs
Input specification	Supports all TRION/TRION3 (high-speed) series interface modules. Optimized to operate with high-speed TRION3 series modules.
Open slots for TRION/TRION3 modules	4
Features	<ul style="list-style-type: none"> – 1 programmable frequency output 10 to 1,000,000 Hz) – 2 advanced counter input, 2 basic counter – 8 digital inputs, 4 digital outputs
High-speed channel expansion	Add TRIONet at any time by SYNC interfaces or other instruments via OXYGEN-NET
Low-speed channel expansion (100 Hz)	CPAD3 via TRION-CAN
Quasi-static channel expansion	EPAD2 interface connector, CPAD2 via TRION-CAN
MBTF	22,769 h
Main system	
System bandwidth	400 MB/s
Data storage	1 TB SSD dedicated for data storage (400 MB/s) ¹⁾ 256 GB SSD for operating system and application software
Display	13.3" wide-screen multi-touch full HD display (1920 x 1080 px)
Power supply input	Internal UPS battery for <5 min. (dep. on system and configuration) 11...32 V _{DC} (max. 10...36 V _{DC}), 210 W isolated, external AC power supply included
<ul style="list-style-type: none"> – DW2-PS-PC-BUFFER (optional) – Rated input voltage 	
Power consumption incl. modules	Typ. 150 W (depending on installed TRION/TRION3 series modules)
Cooling capacity	25 W per module slot
Dimensions (W x D x H) without feet	317 x 253 x 124 mm (12.5 x 10 x 4.9 in.)
Weight w/o TRION modules	Typ. 6 kg (13.22 lbs)
Environmental specifications	
Operating temperature	0 °C to +50 °C, down to -20 °C with pre-warmed unit
Storage temperature	-20 °C to +70 °C
Humidity	10 % to 80 %, non condensing; 5 % to 95 % rel. humidity
Altitude ²⁾	4000 m (13,123 ft.)

Tab. 1: System specifications DEWE3-A4

DEWE3-A4	
Sine vibration test; EN 60068-2-6	
Shape	Sine
Frequency range	10–150 Hz
Acceleration	20 m/s ²
Sweep rate	1 oct./min.
Duration test in 3 directions	20 cycles
Random vibration test; EN 60721-3-2; Class 2M3	
Frequency range	10–200 Hz
Spectral acceleration density	3 m ² /s ³
Duration	30 minutes/direction
Shocktests; EN 60068-2-27	
Pulse form	Half-sine
Acceleration amplitude	30 g
Duration	11 ms
Direction	3 bumps each direction, 6 directions in total

Tab. 1: System specifications DEWE3-A4

¹⁾ The max. data throughput is limited when using the 4 TB SSD option.

²⁾ Depending on installed TRION series modules. Refer to the TRION technical reference manual.

Dimensions*

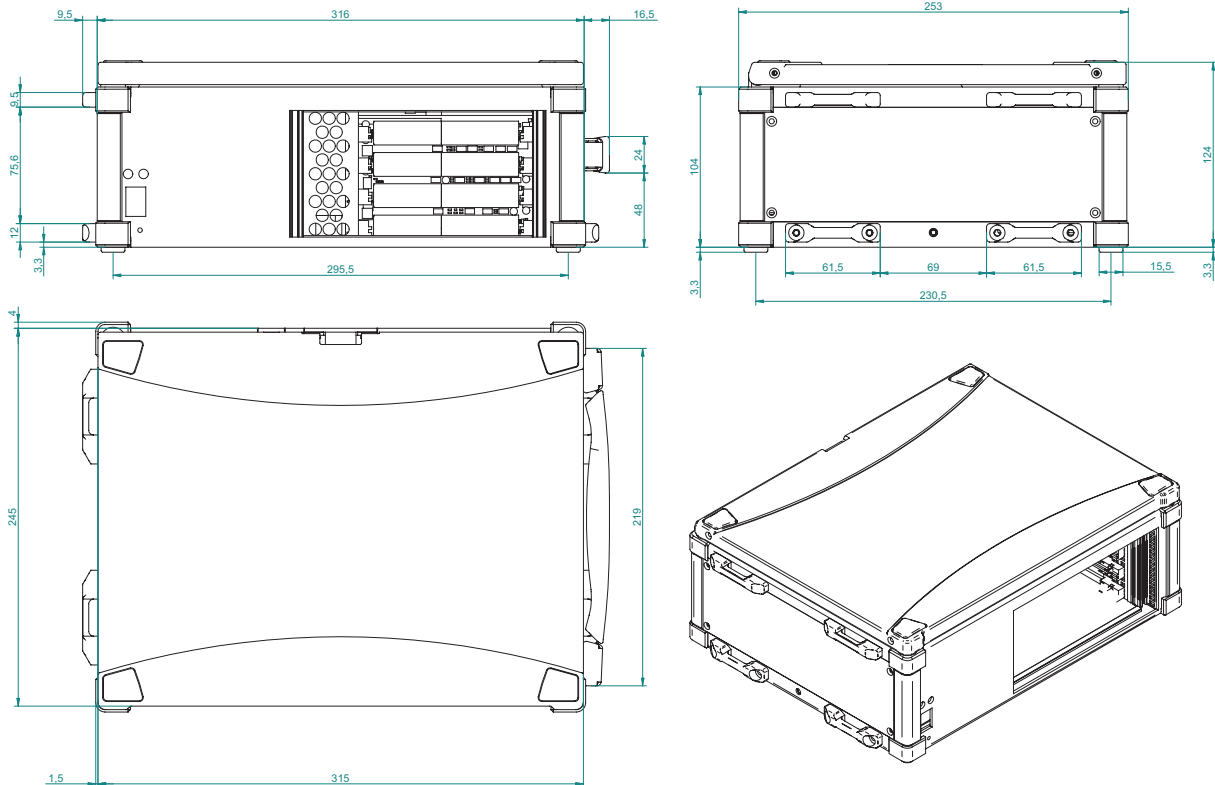

*) Dimensions in mm (1 inch = 25.4 mm)

Fig. 1: Dimensions DEWE3-A4

MAIN SYSTEM

Block diagram

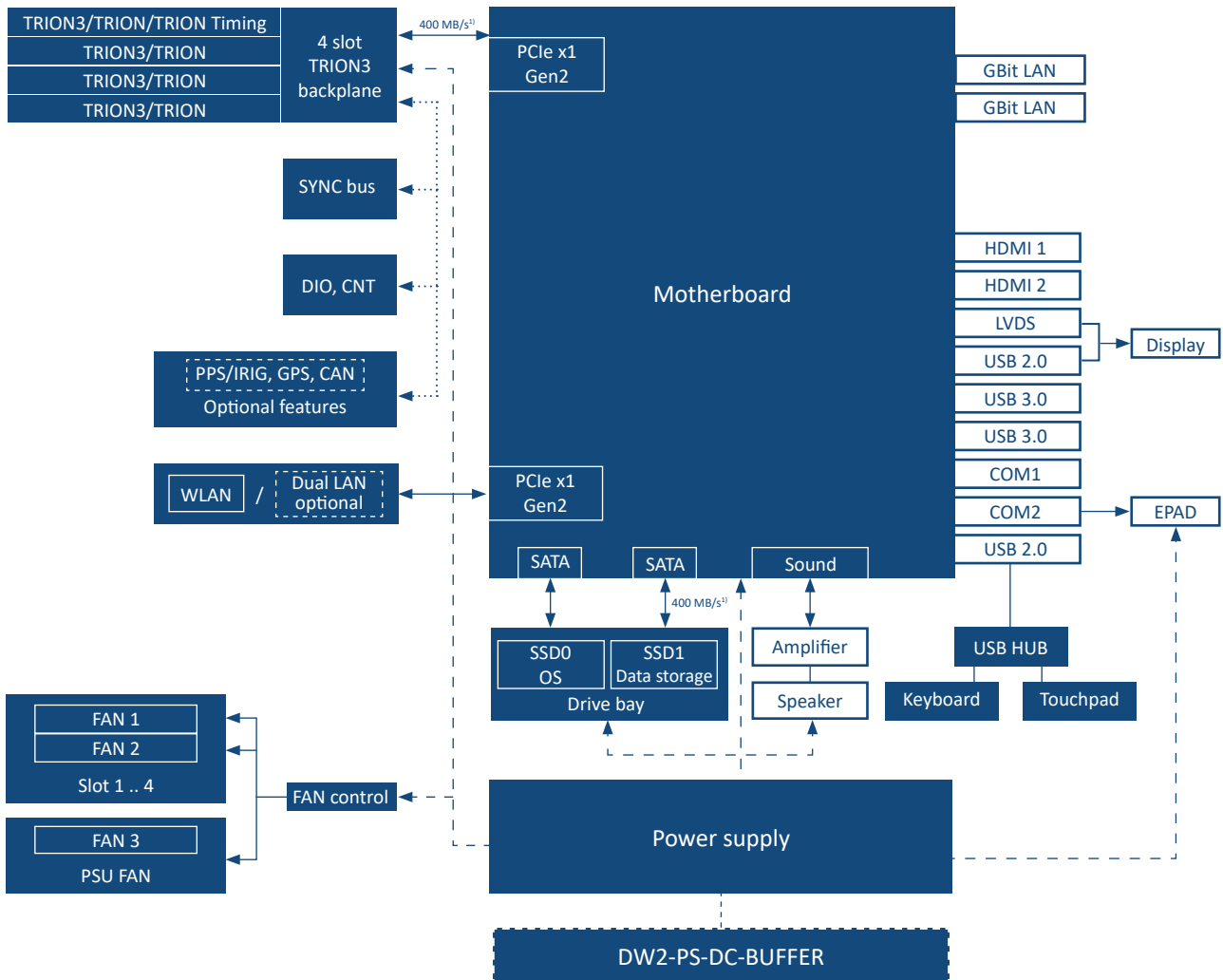

Fig. 2: Block diagram

¹⁾ The max. data throughput is limited when using the 4 TB SSD option.

Connections and ports

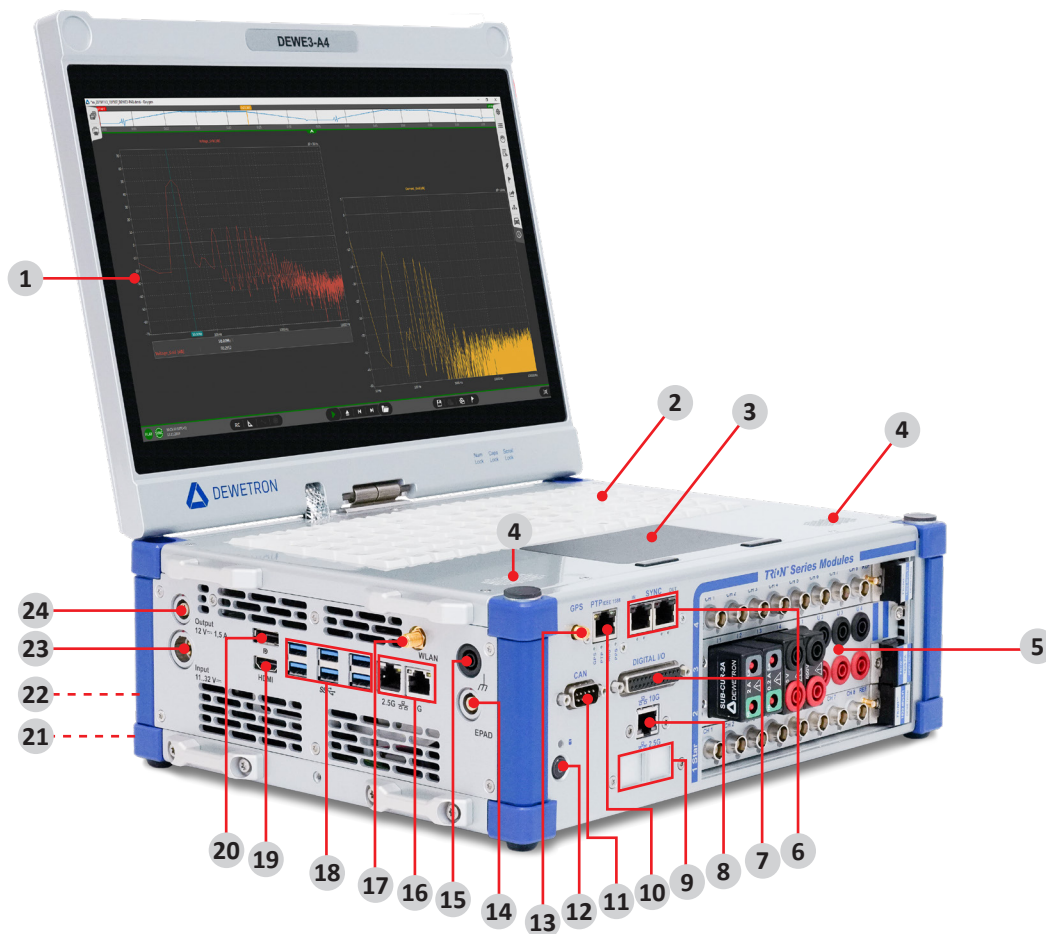

Fig. 3: DEWE3-A4 connections and ports

1. [Touchscreen](#)
2. Integrated 84-keys keyboard
3. [Touchpad](#)
4. Integrated speakers
5. [TRION/TRION3 series module slots](#)
6. [TRION SYNC-BUS](#)
7. [Digital I/O connector](#)
8. Optional [Gigabit Ethernet LAN connectors](#) 10G
9. Optional [Gigabit Ethernet LAN connectors](#) 2.5G
10. [PTP/IEEE 1588 \(optional\)](#)¹⁾
11. [CAN connector \(optional\)](#)¹⁾
12. [Power on/off push button and status LED](#)
13. [GPS \(optional\)](#)¹⁾
14. [EPAD2 connector](#)
15. [Chassis terminal](#) (ground connection)
16. [Gigabit Ethernet LAN connectors](#) (1G and 2.5G)
17. WLAN antenna (802.11 ac)
18. [USB 3.2 interface connectors](#)
19. [HDMI connector](#)
20. [DisplayPort connector](#)
21. [SSD drive bay](#) for operating system and application software (on backside)
22. [Nameplate](#) and [Options label](#) (on backside)
23. [Power supply input connector](#) (EGJ.2B.302)
24. [Power supply output for accessories](#) (LEMO EGG.1B.302)

1) The interfaces are available on every device, but are only functional if the corresponding option has been purchased.

CONNECTIONS AND PORTS

Power supply

Power supply output for accessories

Accessories are supplied with 12 V_{DC} via an LEMO EGG.1B.302 connector. It is fused with an 1.5 A self-recovering fuse.

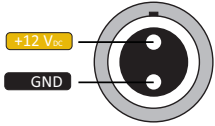

Fig. 4: Pin assignment for accessories power supply output

Mating connector:

- ▶ LEMO FGG.1B.302.CLAD52Z (for cable diameter 4.1 to 5.0 mm)
- ▶ LEMO FGG.1B.302.CLAD62Z (for cable diameter 5.1 to 6.0 mm)

Power supply input connector

The DEWE3-A4 is delivered with a standard external AC/DC power supply.

Internal DC power supply

210 W DC power supply		
	Input <ul style="list-style-type: none"> – Rated input voltage – Input frequency – Power – Connector 	11...32 V _{DC} (max. 10...36 V _{DC}) DC 210 W 2-pin male LEMO EGJ.2B.302

Tab. 2: Specifications internal 210 W DC power supply

External AC/DC power supply

250 W AC/DC power supply		
	Input <ul style="list-style-type: none"> – Rated input voltage – Input frequency – Current 	100...240 V _{AC} (max. 90 ... 264 V _{AC}) 50...60 Hz max. 3 A
	Output <ul style="list-style-type: none"> – Voltage – Current – Output power 	24 V _{DC} 10.42 A (max. load) max. 250 W

Tab. 3: Specifications external 250 W AC/DC power supply

DW2-PS-DC-BUFFER (option)

The DEWE3-x4 systems are equipped with an internal buffer battery to bridge supply voltage drops of up to 5 min. This option is especially useful for in-vehicle testing to bridge the battery voltage drop when starting the engine but also for many other applications where short power breakdowns must not interrupt the measurement, e.g. power monitoring.

CONNECTIONS AND PORTS

NOTICE

Battery exchange has to be done by qualified persons only.

DW2-UPS-250-DC (option)



- ▶ DC power supply with 3 hot swappable batteries
- ▶ 250 power for one hour with internal batteries
- ▶ Charge and discharge state via COM interface
- ▶ Including external 115/230 V_{AC} adapter
- ▶ Expectable runtime with 3 batteries: ~2 h (average configuration) / ~1.2 h (max. configuration)

Power on/off push button and status LED

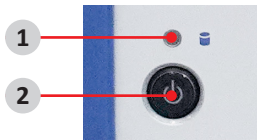

Fig. 5: Power on/off push button and status LED

1. SSD activity
2. Power on/off push button

SSD activity LED

The SSD activity LED illuminates whenever the solid state drive or is being read from or written to.

NOTICE

To avoid data loss, do not remove the battery or disconnect the device from the power supply while the operating system is still accessing files on the drive.

Power on/off push button

The power on/off push button at the front of the system is used to switch the system on and off. It only works if the main power switch (**11**) on the rear of the instrument is switched to position 'I'.

When the mainboard is switched on, the on/off button lights up blue. To switch the system on, press the button. To shut it down, press the button again; to immediately switch it off, press the button for longer than 4 seconds.

Buzzer

The built-in buzzer indicates the following statuses:

Beep	Status
1x beep tone	Low battery alarm
2x beep tone	Critical battery alarm
3x beep tone	Critical system alarm

Tab. 4: Buzzer

CONNECTIONS AND PORTS

Sync and digital interfaces

Overview

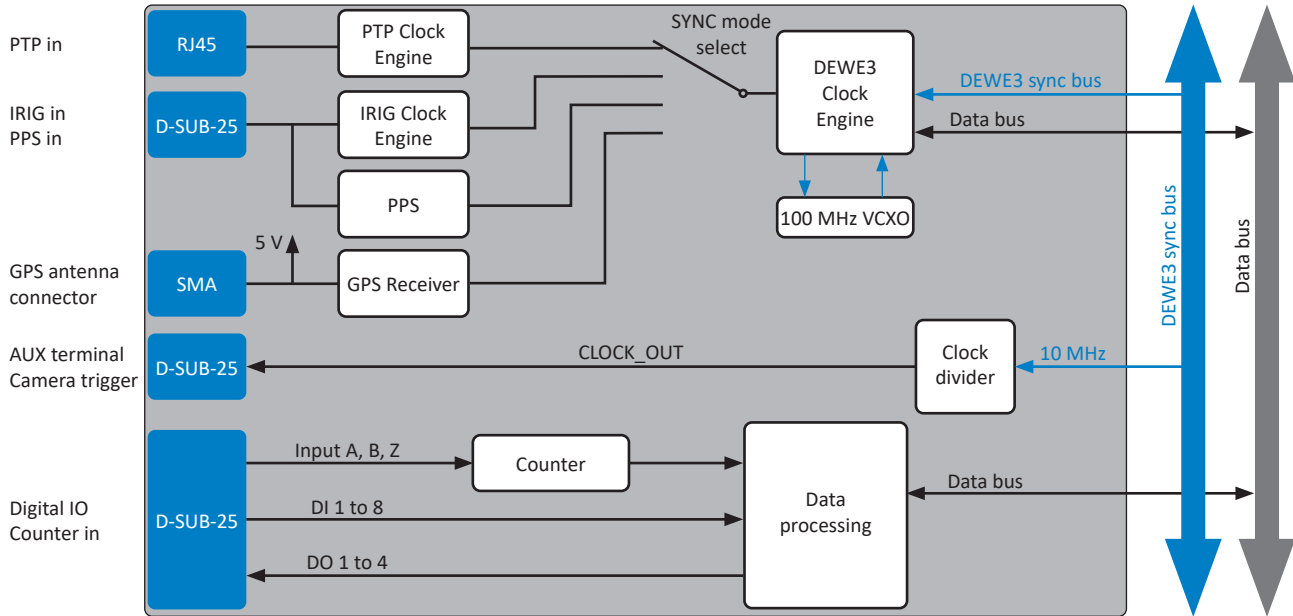

Fig. 6: Signal routing

Active sync LEDs

Active mode LEDs			
GPS 0	PTP 0	IRIG 0	PPS 0
The 4 LEDs indicate the active synchronization source and the current synchronization status by flashing the respective LED.			

Tab. 5: Active sync LEDs

TRION SYNC-BUS

The TRION SYNC-BUS allows an easy high-speed channel expansion with TRIONet front-ends or distributed high channel-count systems featuring OXYGEN with the OXY-OPT-NET software option.

Digital I/O connector

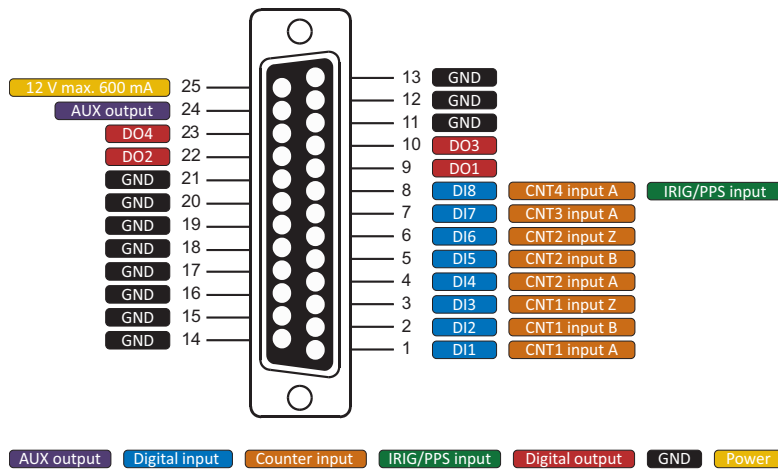

Fig. 7: Pin assignment D-SUB-25 connector

NOTICE

Combined load at D-SUB-9 socket CAN and D-SUB-25 socket digital I/O max. 600 mA at 12 V.

Digital I/O connector specifications		
Digital IN	Digital input	8 CMOS/TTL compatible digital inputs; weak pull-up via 100 k Ω
	Overtoltage protection	$\pm 30 V_{DC}$, $50 V_{PEAK}$ (100 ms)
	Counter	4 counter channels; TTL input; shared with digital inputs
	Counter modes	
	– Waveform timing	Period, frequency, pulse width duty cycle and edge separation
	– Sensor modes	Encoder (angle and linear)
	– Event counting	Basic event count. gated count., up/down count. and encoder mode (X1, X2 and X4)
	Counter resolution	32-bit
	Counter time base	100 MHz
	Time base accuracy	Typ. 2 ppm; max. 10 ppm
Max. input frequency	10 MHz	
Sensor power supply	12 V (600 mA)	
Digital OUT	Digital output	4 DO; TTL
	Output indication	LED (green = high; off = low)
	Maximum current	25 mA continuously
	Power-on default	Low
Connector	D-SUB-25 socket	

Tab. 6: Digital I/O connector specifications

CONNECTIONS AND PORTS

AUX terminal

AUX specifications		
	Functionality	Camera trigger, trigger output, acquisition clock and programmable clock output
	Compatibility (output)	LVTTTL, 10 mA
	Overvoltage protection	$\pm 20 V_{DC}$
	Power-on default	Low
	Connection	Pin 24 on digital I/O connector

Tab. 7: AUX specifications

The auxiliary terminal could be used as programmable frequency output for synchronizing external hardware.

The output can be set in the Sync Out AUX settings via *System Settings* → *Sync Setup* → *Sync Out Aux*:



Fig. 8: Output settings

PPS terminal

PPS specifications			
	Supported codes	PPS	
	Compatibility (DC code)	DC level shift (edge detection); TTL/CMOS compatible	
		Low: <0.8 V	High: >2 V
Connection	Pin 8 on digital I/O connector		

Tab. 8: PPS specifications

Counter and digital I/O

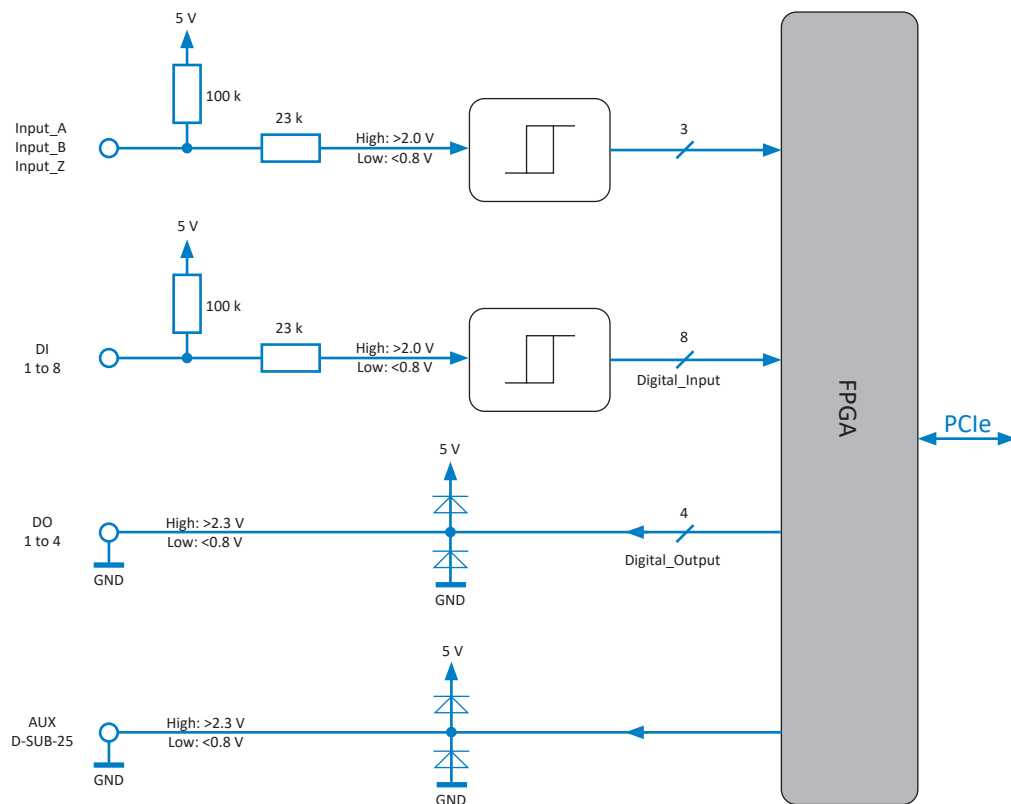



Fig. 9: Counter and digital I/O

Advanced counter

The supports an advanced counter via the pins 1–8 of the digital I/O connector shown in Fig. 7. For information regarding advanced counters refer to [Functional description of advanced counter on page 189](#) of the TRION(3) series modules manual.

GPS (optional)

The DEWE3-OPT-GPS function is an optional feature and provides the following synchronization input modes:

GPS specifications		
	Synchronization input modes	GPS
	Supported GNSS signals	GPS/Glonass/BeiDou/QZSS
	PPS accuracy	100 ns
	Refresh rate	1 Hz
	Position accuracy (horizontal CEP)	INFORMATION CEP 50 %, 24 h static, roof antenna
	– Autonomous	<2.5 m
	– Differential	<2.5 m
Input connector GPS	SMA for GPS antenna	

Tab. 9: GPS specifications

CONNECTIONS AND PORTS

DEWE2/3 clock engine

The DEWE3-A4 is designed for continuously measuring data, even if the external time base source is temporarily not available. Especially in GPS mode that could easily happen. Reason for that is the weather sensitive GPS reception. One cloud might be enough to interrupt the synchronization for a while. In that case the TRION-TIMING-V3 generates a notifying event and continues measuring on its internal time base. This internal time base has been adjusted to the external reference while the sync was stable.

That minimizes the drift in free-run mode. Typically it is far below 1 ppm. Only when the environmental conditions change dramatically during a longer non-synced period of time, it might go up to a maximum of 10 ppm.

When the synchronization has established again the TRION-TIMING checks if the internal time base error is still below the pre-programmed restart limit. If yes, it starts resyncing by slightly changing the time-base until the time stamps matches again exactly. That prevents from gaps in the data file due to resync. That might take a while because the maximum readjusting speed is 100 ppm. If for some reason a hard resync is needed the restart limit could be set to a low value. In that case the datafile will be interrupted.

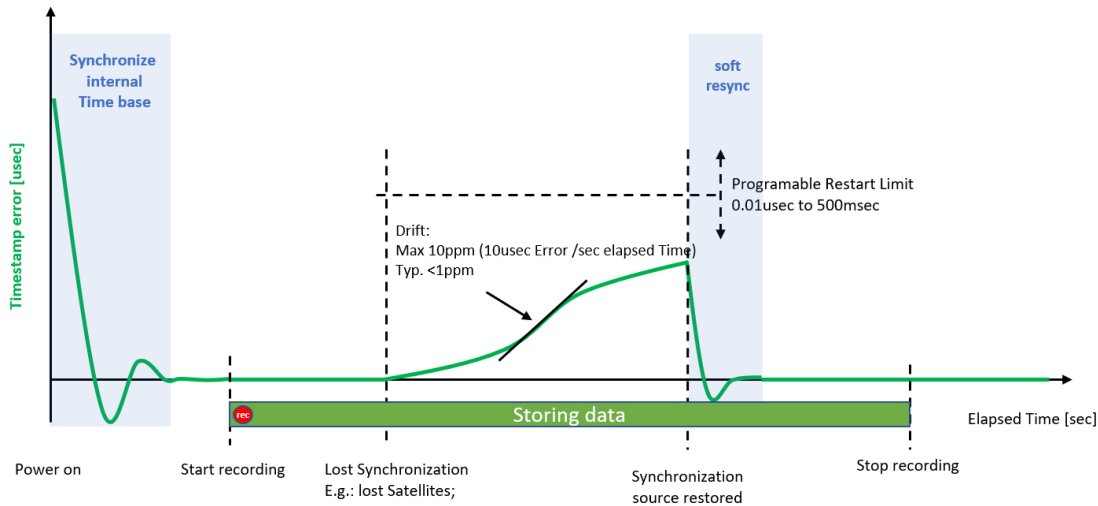

Fig. 10: Gapless recording

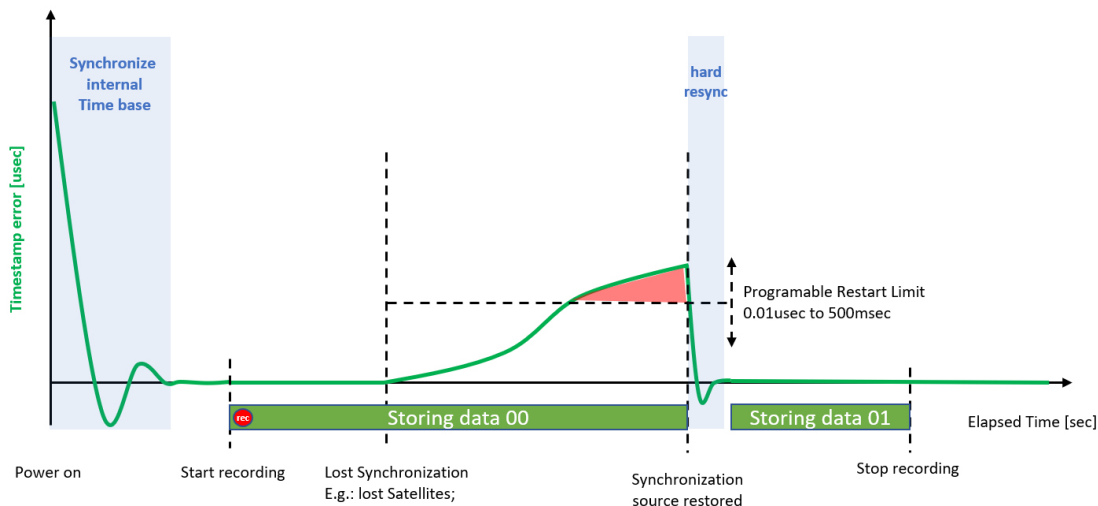

Fig. 11: Forced restart after restored synchronization

CONNECTIONS AND PORTS

INFORMATION

If the system is equipped with a TRION-BASE, TRION-TIMING or TRION-VGPS-20/-100 module, it must be installed in the “star slot”.

Optional accessory

TRION-CBL-CAMTRG-ALV-05

Camera trigger cable (5 m) to synchronize a CAM-ALVIUM-1800-U camera via an AUX socket of TRION modules or on the front plate of a DEWE3-A4 and DEWE3-M4.

INFORMATION The type of TRION module or whether the camera is to be connected to the front panel must be specified before ordering.

TRION-CBL-CAMTRG-GIGE-03

Camera trigger cable (3 m) to synchronize a DEWE-CAM-GIGE camera via an AUX socket of TRION modules or on the front plate of a DEWE3-A4 and DEWE3-M4.

INFORMATION The type of TRION module or whether the camera is to be connected to the front panel must be specified before ordering.

GPS-ANT-FIXED



GNSS/GPS antenna for TRION-TIMING, for fixed installation. Only supports GPS L1.

GPS-ANT-MOB



IP67 compliant, magnetic GNSS/GPS antenna for TRION-TIMING for mobile applications. Support of GPS L1, GLONASS G1, SBAS (WAAS, EGNOS & MSAS).

5 m cable, SMA plug

PTP/IEEE 1588 (optional)

The DEWE3-OPT-IRIG/PTP function is an optional feature and provides the following synchronization input modes:

- ▶ PTP/IEEE 1588
- ▶ IRIG

PTP/IEEE 1588 specifications		
	IP mode	Multicast
	Protocol	UDP / IPv4; ETH
	Delay mechanism	End-to-end; peer-to-peer
	IP address method	DHCP
	Connector	RJ-45 Ethernet plug for 10 / 100 Mbit Ethernet connection; only for synchronization, no data transfer possible
	Programmable correction limit	10 ns to 500 ms

Tab. 10: PTP/IEEE 1588 specifications

CONNECTIONS AND PORTS

IRIG input specifications

Supported codes	IRIG code A or B; DC	
Compatibility (DC code)	DC level shift (edge detection); TTL / CMOS compatible	
	Low: <0.8 V	High: >2 V

Tab. 11: IRIG input specifications

CAN connector (optional)

The DEWE3-OPT-CAN function is an optional feature and provides the following synchronization input modes:

CAN specifications

	Input channels	1 D-SUB-9 connector, not isolated
	Specification	CAN 2.0B
	Physical layer	High-speed
	Listen-only mode	Supported
	Termination	Programmable: high impedance or 120 Ω
	Common mode range	-2 V to +7 V
	Bus pin fault protection	±36 V _{DC}
	ESD protection	IEC 61000-4-2: ±8 kV air discharge, ±4 kV contact discharge
	CAN transceiver	SN65HVD266D
	Sensor power supply	5 V (100 mA) and 12 V (600 mA)

Tab. 12: GPS specifications

NOTICE

Combined load at D-SUB-9 socket CAN and D-SUB-25 socket digital I/O max. 600 mA at 12 V.

Connection

The measurement is carried out via D-SUB cord. The CAN bus is not isolated.

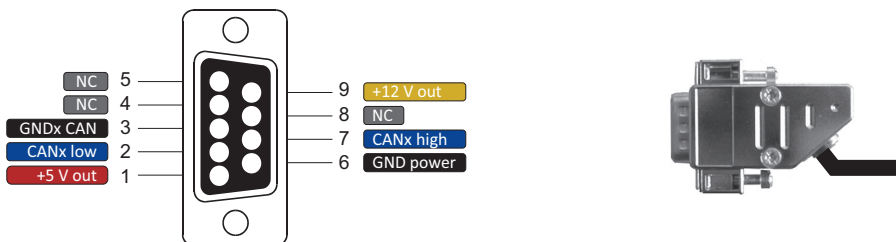

Fig. 12: D-SUB-9 CAN connector pin assignment

High-speed CAN

The high-speed CAN is a differential bus where complementary signals are sent over two wires. The voltage difference between the two wires defines the logical state of the bus. The differential CAN receiver monitors this voltage difference and outputs the bus state with a single-ended output signal.

The high-speed CAN bus topology as well as the possible cable lengths and the recommended termination resistors are specified in the standards ISO-11898 and CiA 102.

The high-speed CAN bus supports bit rates of up to 1 Mbit/s (or >125 kbit/s).

The schematic below will give you an overview of the high-speed CAN bus topology and the termination resistor placement.

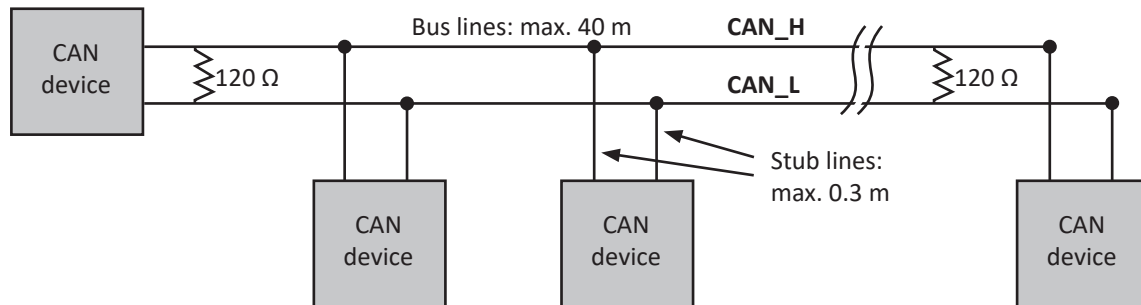

Fig. 13: High-speed CAN

Cable lengths for high-speed CAN bus

The cabling characteristics and the desired bit transmission rate affect the allowable cable length. ISO-11898 standard specifies a maximum bus length of 40 m and a maximum stub length of 0.3 m with a maximum of 30 nodes for a bitrate of 1 Mbit/s. However, with careful design, users can have longer cables, longer stub lengths, and many more nodes to a bus. A large number of nodes requires a transceiver with high input impedance and each node should be analyzed for signal integrity problems.

Characteristics of two-wire differential bus:

- ▶ Impedance: 108 Ω min., 120 Ω nominal, 132 Ω max.
- ▶ Length-related resistance: 70 m Ω /m nominal
- ▶ Nominal specific propagation delay: 5 ns/m nominal

For further information see ISO-11898 and CiA 102 specifications.

Termination

CAN_H and CAN_L are transmission lines. If the transmission line is not terminated, each signal line causes reflections which can cause communication failures therefore both ends of the cable have to be terminated. If multiple devices are connected only the devices at the ends of the cable need to be terminated. Recommended termination resistors in a high-speed CAN bus topology (according to ISO-11898): 120 Ω .

The TRION-CAN module offers a programmable termination resistance, either high impedance or 120 Ω .

Optional accessory

TRION-CBL-D9-OE-05-00

High quality cable from D-SUB-9 socket to open end, 5 m.

TRION-CBL-D9-CPAD-01-00

High-quality cable from D-SUB-9 socket to CPAD, 1 m.

USB 3.2 interface connectors

The device is equipped with 6 USB 3.2 interface connectors on the front side. All of them meet standard USB pin assignments.

Display port & HDMI connectors

The DEWE3-A4 supports a maximum of 2 screens at the same time.

CONNECTIONS AND PORTS

Chassis terminal



For some kind of measurements, it is necessary to provide the system with an additional ground connection.

Gigabit Ethernet LAN connectors

The DEWE3-A4 supports Gigabit Ethernet interface ports for connecting the DEWE3-A4 with a laptop/PC or daisy-chaining multiple units with standard RJ45 connector. The Gigabit Ethernet interface connectors on the DEWE3-A4 have two LEDs displaying following statuses:

1G LAN		2.5G LAN	
Color/mode	Status	Color/mode	Status
YELLOW (flashing)	Link active	YELLOW (flashing)	Link active
ORANGE (stable)	1 Gbit speed is in use	ORANGE (stable)	2.5 Gbit speed is in use
		GREEN (stable)	1 Gbit speed is in use

Tab. 13: Ethernet LED indication

NOTICE

The total length of the Ethernet cable must not exceed 100 m (328 ft) between two units.

EPAD2 connector

To connect DEWETRON EPAD2 modules to the system, a LEMO EGG.1B.304 socket is provided. Shield is connected on housing.

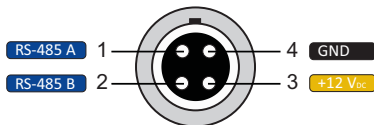

Fig. 14: Pin assignment EPAD2 connector

Mating connector

- ▶ LEMO FGG.1B.304.CLAD52Z (for cable diameter 4.1 to 5.0 mm)
- ▶ LEMO FGG.1B.304.CLAD62Z (for cable diameter 5.1 to 6.0 mm)

TRION/TRION3 series module slots

The device is equipped with 4 slots for TRION/TRION3 series modules. The DEWE3-A4 supports all modules. For details see [DEWE3/TRION\(3\) hardware compatibility on page 30](#).

For more information about the various modules refer to [TRION series modules overview on page 30](#).

Touchpad

The device can be controlled via a multi-touch touchpad with 2 designated keys. Additionally, pressing on the touchpad also triggers a keystroke (left or right key depending on the position of the finger on the touchpad).

The available gestures of the touchpad can be customized via the touchpad settings in the Windows system settings.



Fig. 15: Multi-touch touchpad

Touchscreen

The DEWE3-A4 is equipped with a bright 13.3" wide-screen multi-touch full HD display to control the instrument. You can use your fingers on the touchscreen, like you would on a smartphone. For example, drag the sidebar from the right side across the screen to open the channel setup.

Tap



- ▶ Tap once on something.
- ▶ Open, selects, or activates whatever you tap.
- ▶ Similar to clicking with a mouse.

Pinch or stretch



- ▶ Touch the screen with two fingers, and then move the fingers
 - toward each other (pinch) **or**
 - away from each other (stretch)
- ▶ Zooms in or out of a graph or data.

Tap and hold



- ▶ Press your finger down and hold for about a second.
- ▶ Rearranges objects on your main screen.

Swipe and drag



- ▶ Drag your finger on the screen.
- ▶ Scrolls through recorded data (like scrolling with a mouse).
- ▶ Drags the sidebar from the right side across the screen to open the channel setup.

CONNECTIONS AND PORTS

SSD drive bay

The DEWE3-A4 equipped with a drive bay for a pre-installed 1 TB SSD (400 MB/s) dedicated for data storage, as well as a 256 GB SSD for operating system and application software.

Option SSD-256G-1T-EL

Upgrade from 256 GB SSD to industrial grade 1 TB SSD with extended life-time 1200 TBW (Tera-Byte Written). Standard SSDs offer typ. 300 to 400 TBW.

NOTICE

Information for systems with SSD drives: Wait for 40 seconds after big files were deleted. The HDD activity LED is lit to indicate that the SSD is deleting the file and TRIM/garbage collection is in progress. Wait until the process is finished before you start to write the next file.

Labels

Nameplate

The nameplate is located on the backside of the device. It indicates the product name and serial number as well as information about the power properties and manufacturer.

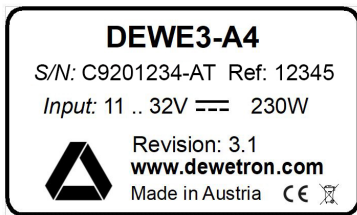

Fig. 16: Nameplate

Options label

This label is located on the backside of the device and indicates the available optional functions.



Fig. 17: Options label

Options and accessoires

Chassis controller options	
DEWE3-OPT-CAN	Optional CAN port on front plate
DEWE3-OPT-IRIG/PTP	Optional IRIG/PTP sync available on front plate
DEWE3-OPT-GPS	Optional GPS sync available on front plate including a GPS antenna

CONNECTIONS AND PORTS

Upgrades	
OPT-LINUX	Linux Ubuntu option for DEWE3 systems
OPT-SECURE-BOOT	Windows secure boot option (DoD-ready) for a new DEWETRON system
UPG-OPT-x4-2x2.5-GBit-LAN	Installation of 2 additional 2.5G LAN interfaces on the front of the device
UPG-OPT-x4-1x10-GBit-LAN	Installation of 1 additional 10G LAN interfaces on the front of the device

Power supply and cables	
DW2-PS-DC-BUFFER	Internal buffer battery; bridges outages of the supply voltage up to approx. 2 minutes. No status information is supplied.
POW-CBL-2B302F-B-2	DC power supply cable LEMO FGJ.2B.302 to 2 male 4 mm banana plugs, 2 m
POW-CBL-3B302F-B-2	DC power supply cable LEMO FGJ.3B.302 to 2 male 4 mm banana plugs, 2 m. Usable with option DW2-PS-DC-300 and DW2-UPS-250-DC

External power supply and battery options	
DW2-UPS-250-DC	<p>External UPS and multi-battery charger with isolated DC input; 3 batteries included; max. output power 250 W, ~25 cm cable set included (longer cables for flexible use of DW2-UPS-250-DC optionally available).</p> <ul style="list-style-type: none"> ▶ Input: 11 to 32 V_{DC}, LEMO EGJ.3B.302, ▶ Output: 12 to 16 V_{DC} when running from batteries and 24 V_{DC} when powered from DC, 3 slots for BAT-89WH batteries, <p>Including external 115/230 V_{AC} adapter for charging batteries, optional 350 W power supply DEWE-POW-24-350 is available for charging the batteries and powering the main system at the same time</p>
DEWE-POW-24-350	External 115/230 V _{AC} power supply 24 V _{DC} , max. 350 W
BAT-28V-CHARGER-1	Desktop battery charger for 1 battery, incl. external AC adapter
BAT-28V-CHARGER-4	Desktop battery charger for 4 batteries, incl. external AC adapter
BAT-89WH	Lithium-ion battery, 14.4 V, 89 Wh, max. 8 A
DW2-CLAMP-DC-POWER-8	External power supply box for up to 8 current transducers; input: 9..36 V _{DC} ; external 115/230 V _{AC} power supply included; current transducer connection: 8 Lemo sockets with ±15 V and +9 V power supply for current transducers; compatible to DEWE2/3 systems

WORKING WITH THE SYSTEM

Working with the system

Hardware

DEWE3/TRION(3) hardware compatibility

In 2019, DEWETRON introduced a new family of data acquisition systems, the DEWE3 and TRION3 express series.

The DEWE3-A4 chassis feature a PXIe hybrid backplane and supports any TRION3™ series modules. It is also backward compatible and does support all TRION™ series modules from previous generation.

The illustrations below will give you an overview of the hardware compatibility and its limitations:

DEWE3-A4 + **TRION3** module (e.g. TRION3-1850-MULTI)

Max. data throughput up to 400 MB/s

DEWE3-A4 + **TRION series module** (e.g. TRION-1603-LV-BNC)

Data throughput up to 100 MB/s

TRION series modules overview

¹⁾ Some versions of this module occupy 2 TRION slots





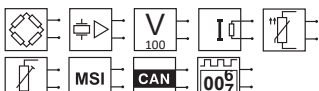

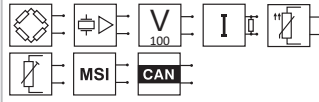

²⁾ CAT III 1000 V only applicable for 1000 V inputs; SUB-600V has CAT II 600 V / CAT III 300 V

Analog modules

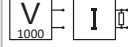
ANALOG modules 	Channels	Sample rate per channel	Resolution	Isolation	Connector type
TRION3-1820-MULTI TRION3-1850-MULTI TRION-1820-MULTI	4 or 8	1850: 5 MS/s 1820: 2 MS/s	24 bit >2 MS/s: 18 bit	yes	D-SUB or LEMO 0B
					



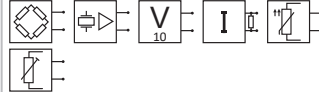
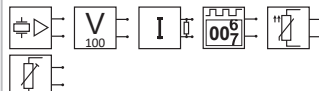

Tab. 14: TRION/TRION3 analog modules

WORKING WITH THE SYSTEM

ANALOG modules 		Channels	Sample rate per channel	Resolution	Isolation	Connector type
TRION-2402-MULTI		4 or 8	200 kS/s	24 bit	yes	D-SUB, LEMO 0B
TRION-1620-ACC		6	2 MS/s	24 bit >1 MS/s: 16 bit	yes	LEMO 1B, BNC
TRION-1620-LV		6	2 MS/s	24 bit >1 MS/s: 16 bit	yes	LEMO 1B, BNC
TRION-2402-V ¹⁾		4 or 8	200 kS/s	24 bit	yes	Safety banana
TRION-1810-HV ¹⁾		4 or 8	1 MS/s	18 bit	yes	Safety banana, CAT III 1000 V ²⁾
TRION3 -1810-SUB-8		8	1 MS/s	16 bit	yes	BNC, LEMO 1B
TRION-1603-LV		6	250 kS/s	18 bit	yes	Safety banana ³⁾
TRION-2402-dSTG ¹⁾		6–8	200 kS/s	24 bit	no	LEMO 1B, LEMO 0B, D-SUB, RJ-45
TRION-2402-dACC		6–8	200 kS/s	24 bit	no	SMB, BNC
TRION-1802-dLV		16 or 32	200 kS/s 100 kS/s	18 bit 24 bit	no	D-SUB
TRION-1600-dLV		16 or 32	20 kS/s	16 bit	no	D-SUB

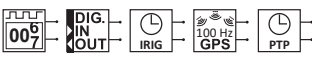
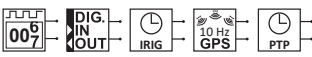

Tab. 14: TRION/TRION3 analog modules

Digital modules

DIGITAL modules 		Channels	Sample rate per channel	Resolution	Isolation	Features
TRION-CNT		6	800 kS/s	80 MHz	yes	6 channel advanced counter
TRION-DI-48		48	2 MS/s	500 nsec	yes	48 high-speed digital IN
TRION-BASE		-	2 MS/s	80 MHz	no	Basic IO card with simple IRIG sync and 2 counter
TRION-VGPS-V3		-	2 MS/s	0.01 km/h <10 cm	no	100 Hz GNSS receiver for automotive applications
TRION-TIMING-V3		-	2 MS/s	12.5 nsec	no	Applies precision absolute time to measured data

Tab. 15: TRION digital modules

WORKING WITH THE SYSTEM

DIGITAL modules		Channels	Sample rate per channel	Resolution	Isolation	Features
TRION-CAN		4	1 MBit	-	yes	D-SUB
TRION-ARINC	-	4 or 16	-	-	no	Decoding of ARINC 429 signals, export of decoded signals
TRION-MIL1533	-	1 or 4	-	-	no	Decoding of MIL-STD 1553 signals, export of decoded signals
TRION-Ether-CAT-1-SLAVE		100	500 S/s	-	no	Measurement data output

Tab. 15: TRION digital modules

Power modules

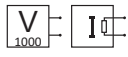
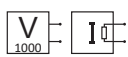
POWER modules		Channels	Sample rate per channel	Resolution	Isolation	Connector type
TRION3 -1810M-POWER ¹⁾		8 (4 U / 4 I)	10 MS/s	24-bit	yes	Safety banana, D-SUB
TRION3 -1820-POWER ¹⁾ TRION-1820-POWER ¹⁾		8 (4 U / 4 I)	2 MS/s	24-bit	yes	Safety banana, D-SUB

Tab. 16: TRION/TRION3 power modules

Analog output modules

ANALOG OUTPUT modules	Channels	Sample rate per channel	Resolution	Isolation	Connector type
TRION3 -1820-MULTI-AOUT	IN 8 OUT 8	IN 2 MS/s OUT 2.5 MS/s	IN 24-bit OUT 32-bit	IN yes OUT yes	IN LEMO 0B OUT DSUB, BNC

Tab. 17: TRION3 analog output modules

Installing a TRION module

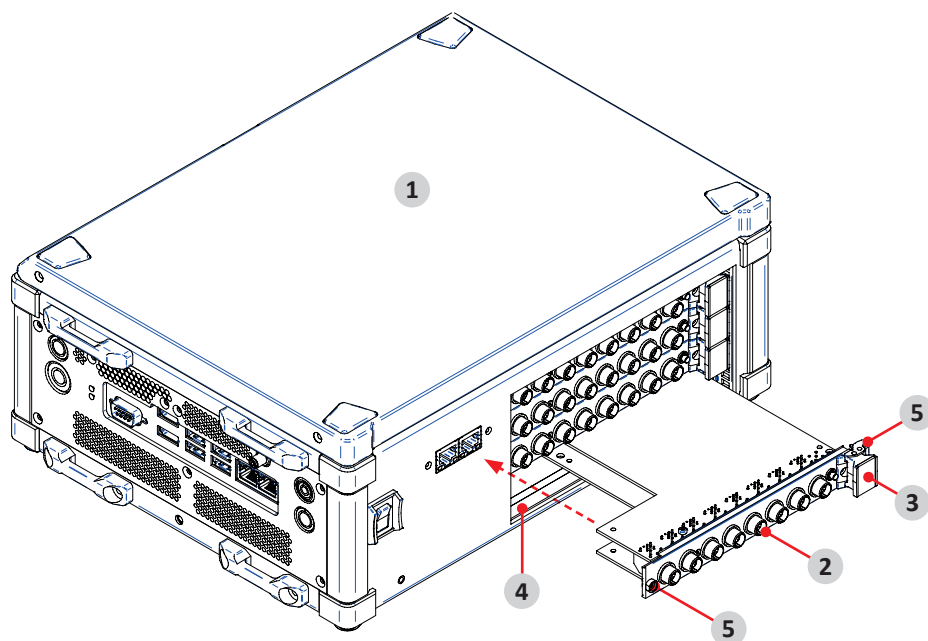



Fig. 18: Installing a TRION module

- | | |
|----------------------------|--------------------|
| 1. DEWE3 chassis | 4. Module guides |
| 2. TRION series module | 5. Mounting screws |
| 3. Injector/ejector module | |

In order to install a TRION module into a chassis proceed as follows:

1.  Take proper ESD precautions to avoid any damage to the unit.
2. Power off and unplug all connected cables including sensors from the DEWE3 chassis and TRION/TRION3 series modules.
3. Identify a supported TRION/TRION3 peripheral slot.
Some modules require a TRION STAR-slot.
4. Remove the filler panel of an unused TRION/TRION3 peripheral or STAR-slot.
5. Place the module edges of the TRION/TRION3 module into the module guide at the top and bottom of the chassis.
6. Insert the TRION/TRION3 module to the rear of the chassis until a resistance appears.
7. Pull up on the injector/ejector handle to latch the device.
8. Secure the installed TRION front panel to the chassis by using the mounting screws.

The TRION/TRION3 module is now installed into a DEWE3 chassis.

NOTICE

Unused TRION slots must always be covered. Make sure to reinstall the filler panels to unused TRION slots to guarantee proper cooling of the installed modules.

The warranty is void if the modules overheat due to missing filler panels.

WORKING WITH THE SYSTEM

Cooling considerations

The intake vent of the DEWE3-A4 is located on the right side, whereas the exhaust vent for is at the left side of the chassis.

NOTICE

Adequate clearance between the chassis and surrounding equipment or blockages must be maintained to ensure proper cooling of the internals of the chassis.

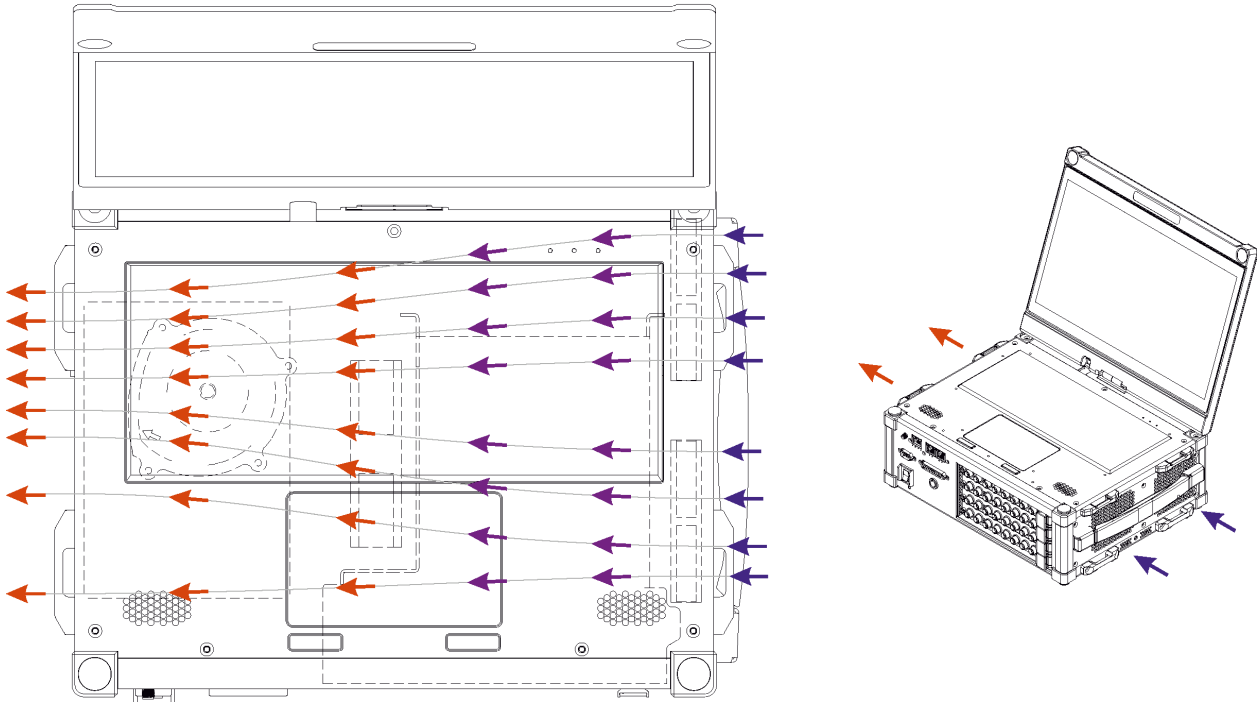

Fig. 19: Cooling concept

Software

Further information on how to operate with OXYGEN find in the corresponding user manual available at:

<https://ccc.dewetron.com/pl/oxygen>

For a more detailed explanation of the OXYGEN software refer to the OXYGEN Technical Reference Manual, which is available at <https://ccc.dewetron.com/pl/oxygen>.

Starting OXYGEN

When starting OXYGEN, the measurement screen is displayed. OXYGEN will instantly start to acquire data but will not store it yet. Fig. 20 shows an overview of the measurement screen and some important buttons and menu tabs.

WORKING WITH THE SYSTEM

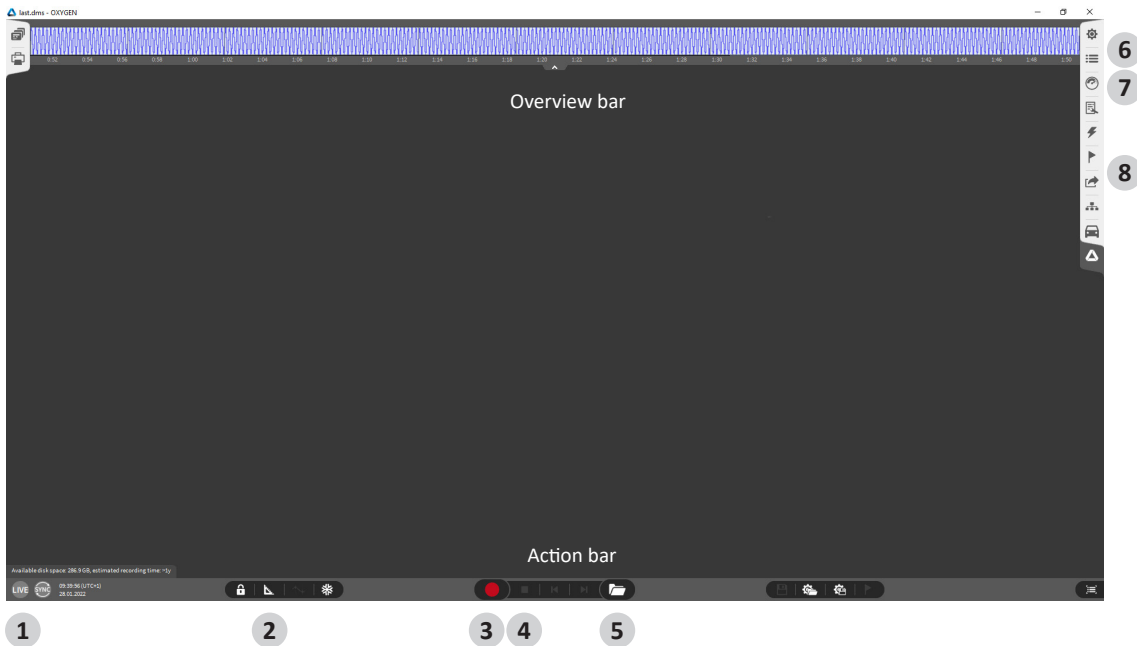

Fig. 20: Measurement screen

1. Software mode indicator
2. Design mode
3. Record
4. Stop
5. Open data file
6. Data channel list menu
7. Instruments menu
8. Export menu

Connect and set up signals and sensors

It is possible to directly measure $\pm 10\text{ V}$ or to use MSIs to expand the input signal possibilities:

Open the Data Channel List by double clicking/tapping on the menu tab on the right side or by swiping it over the whole measurement screen, seen in Fig. 21.

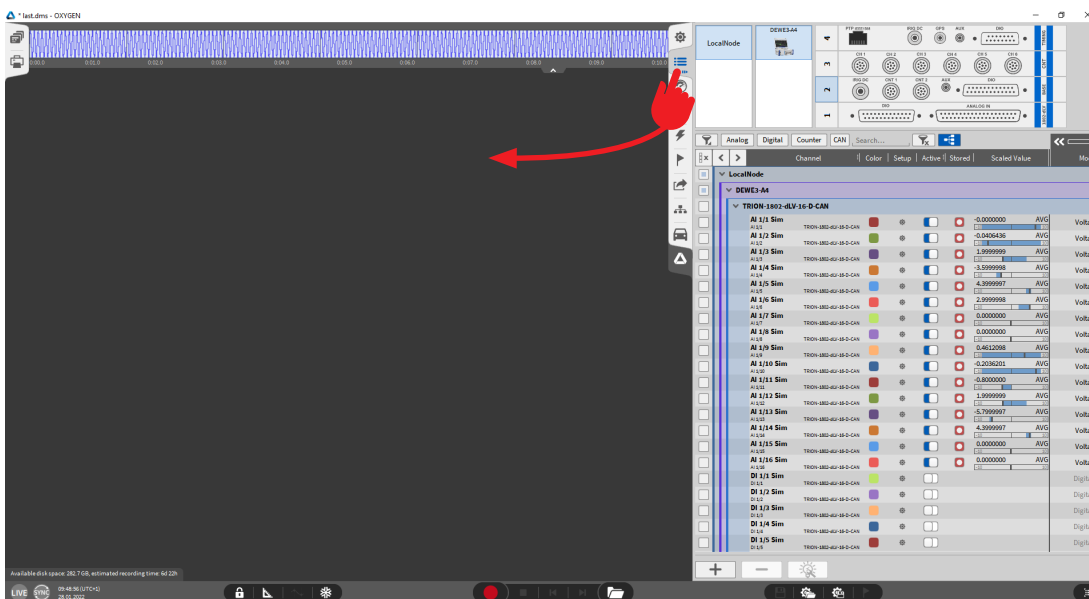

Fig. 21: Expanding data channel list

WORKING WITH THE SYSTEM

Changing channel settings

The next step is to change the channel settings:

1. Click on the channel name in the list to enter a new name.
2. Alternatively, the channel settings will also open by clicking on the gear button (see Fig. 22).

There different settings are available

- ▶ Sensor scaling (unit and scaling or sensitivity factor)
- ▶ Table scaling for a non-linear scaling

All settings are automatically saved when entered and do not have to be saved separately.

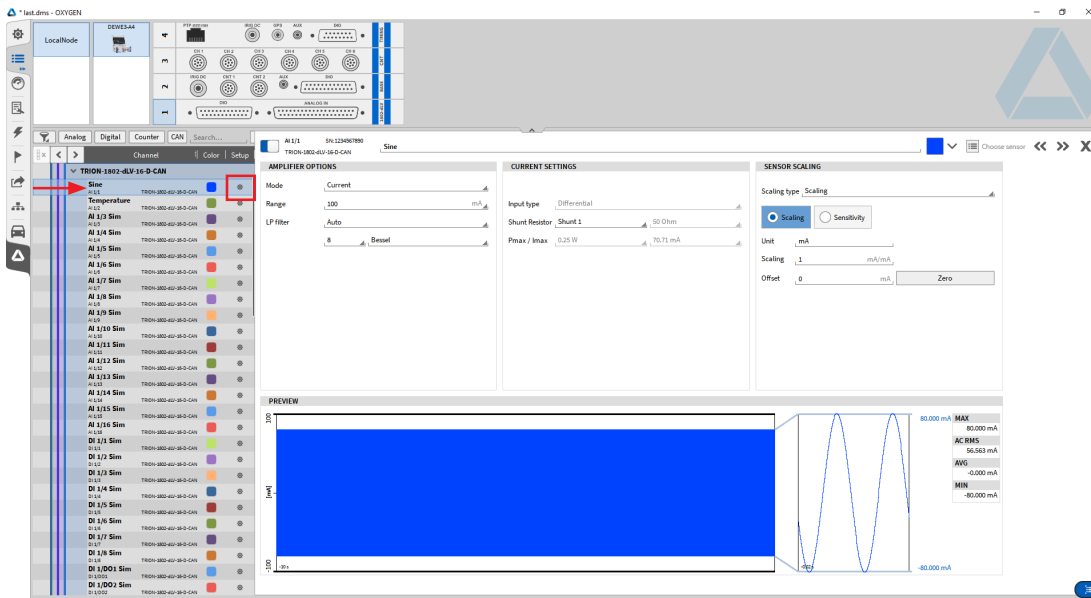

Fig. 22: Changing channel settings

Design the measurement screen

After the channel settings are done, design the measurement screen to your needs:

1. Double-click/tap on the menu tab or swipe the menu to the right.
2. Click or tap on the *Instrument* menu tab and drag and drop a recorder on the measurement screen.

More instruments can be added and adjusted like this, when being in *Design Mode* (see 2 in Fig. 20).

3. Click on the *Data Channel* menu tab and add the signal by selecting the instrument and the signal to be shown or by drag and dropping the signal into the instrument.
4. Disable the *Design Mode*.

The design of the measurement screen is now finished.

WORKING WITH THE SYSTEM

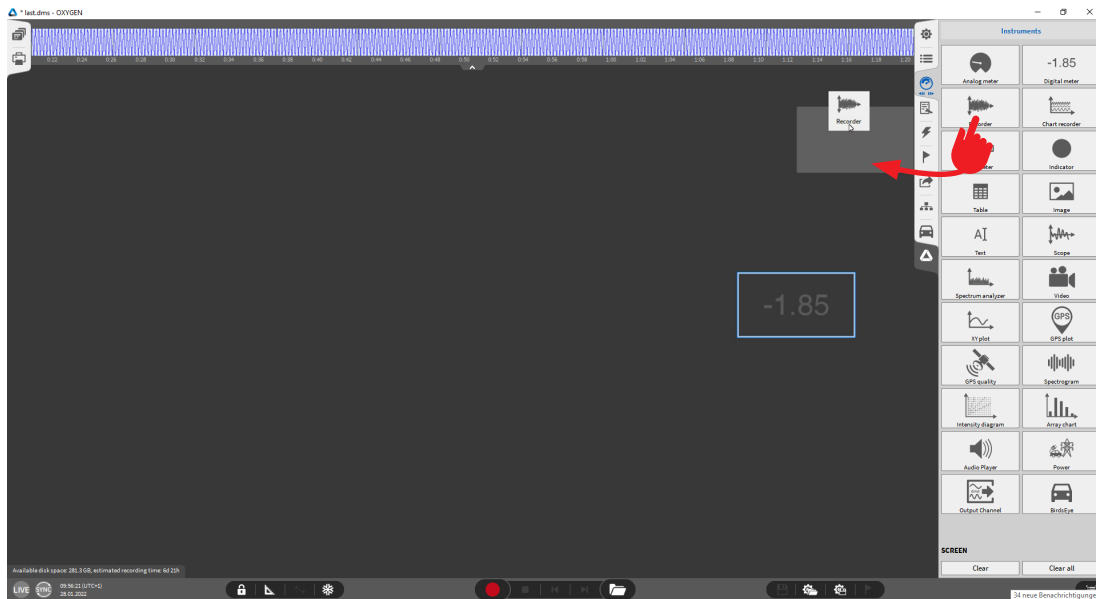

Fig. 23: Designing the measurement screen

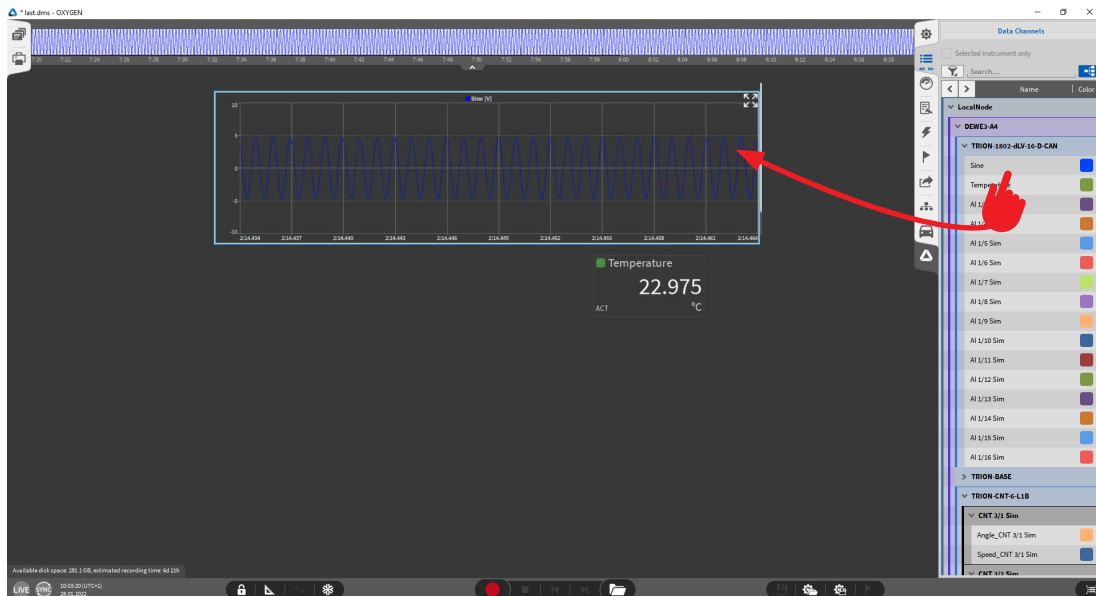

Fig. 24: Selecting instrument and signal

Record

To start the recording proceed as follows.

1. Click on the record button.

The red border and the REC indicator seen Fig. 25 in the lower left corner displays, that the recording is going on.

2. Click on the Stop button to stop the recording.

The recording process is now finished.

WORKING WITH THE SYSTEM

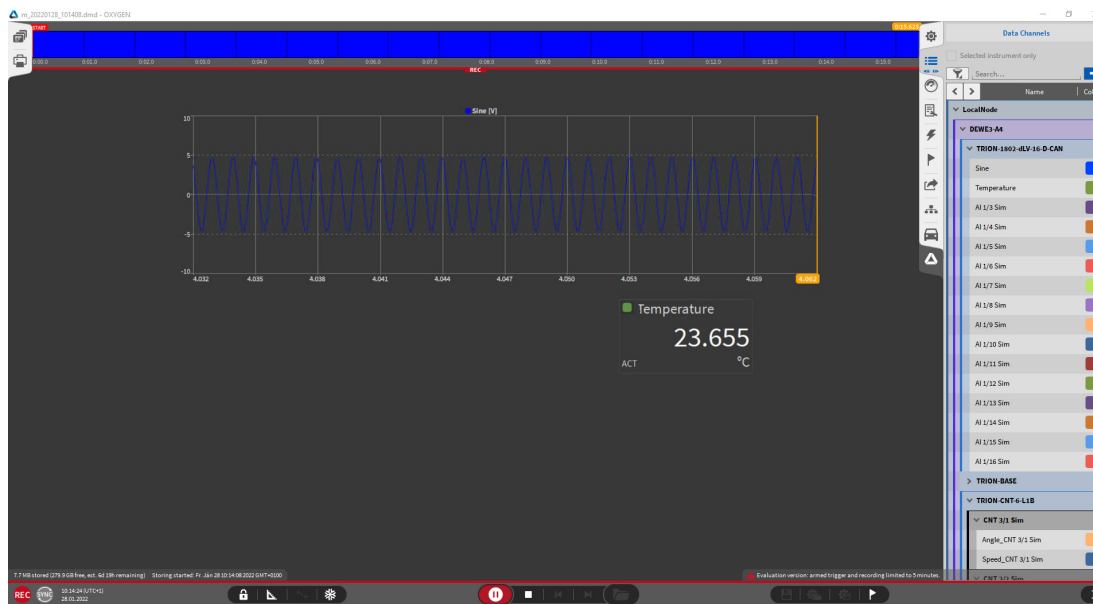

Fig. 25: Recording

Open datafile and export

To open a datafile, proceed as follows:

1. Click on the file button, and select the corresponding file (see Fig. 26).

The green border and PLAY indicator in the lower left corner indicate that a file is loaded for post-processing (see Fig. 27).

2. To export the data, click or tap on the *Export Settings* menu tab.
3. Select the desired format and the channels to be exported.
4. Click on the export button seen in Fig. 27.

The exporting process is now finished.

WORKING WITH THE SYSTEM

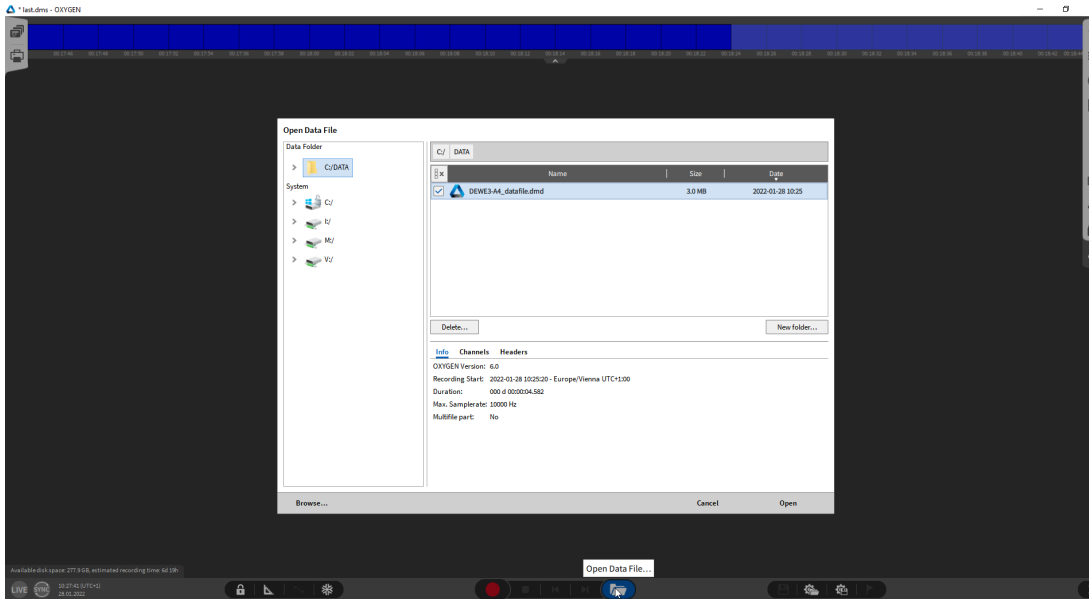

Fig. 26: Opening data file

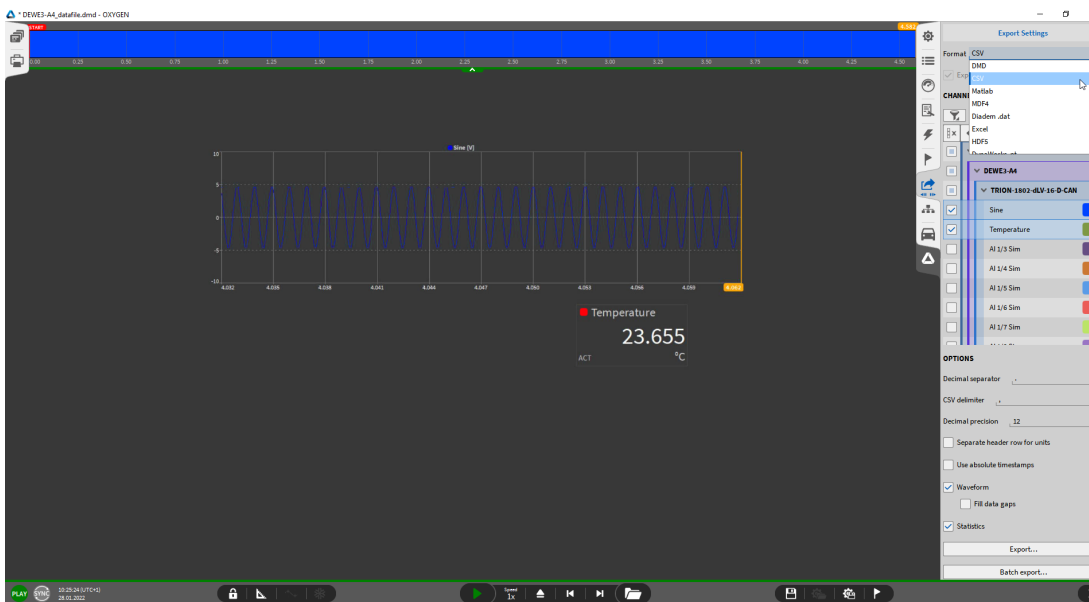

Fig. 27: Exporting data file for post-processing

WORKING WITH THE SYSTEM

Synchronization

The TRION-SYNC-BUS (SYNC IN, SYNC OUT) is used to synchronize two or more DEWE3 systems with up to 100 m distance between each node. The TRION-SYNC-BUS consists of two RJ-45 sockets. One socket is used as synchronization output (OUT), while the other is used as synchronization input (IN).

Depending on the usage of the SYNC I/O (input or output) the LED indicates if the system clock is available or received correctly from another system. The green LED indicates that the acquisition is running. If the acquisition stops the LED will be off.

LED indication	SYNC OUT	SYNC I/O
RED (stable)	Clock detected	Clock detected / receiving clock
Green (stable)	Acquisition running	Acquisition running

Tab. 18: LED indication

Channel expansion with TRIONet

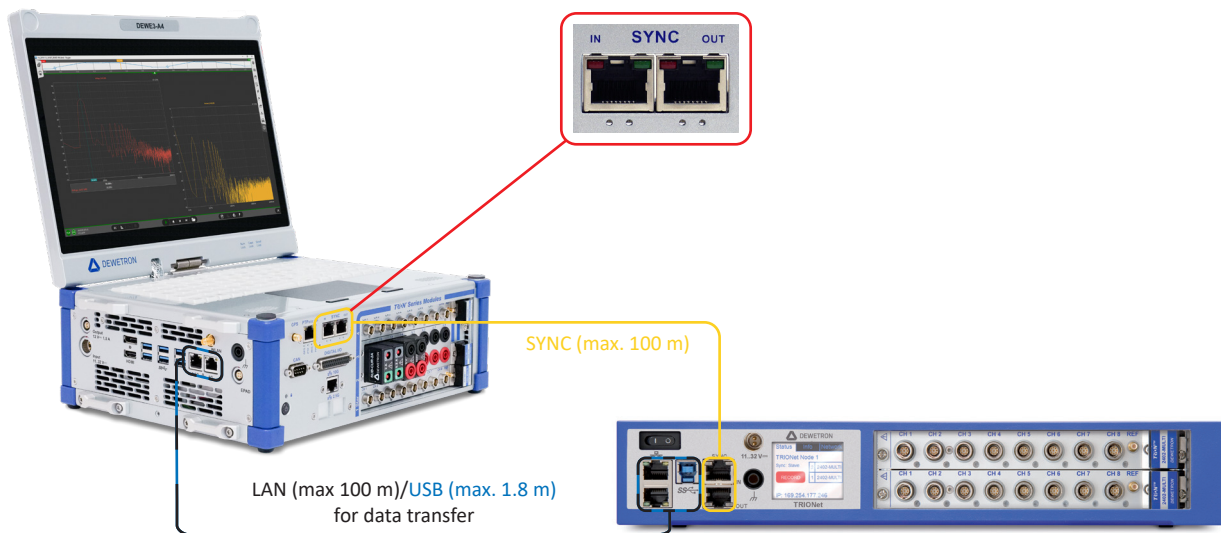

Fig. 28: Channel expansion with TRIONet

WORKING WITH THE SYSTEM

Network with multiple systems



Fig. 29: Network with multiple systems

Absolute time synchronization

With this option, the DEWE3-A4 can operate synchronized with other measurement devices with an absolute time reference.

PTP sync / IRIG sync

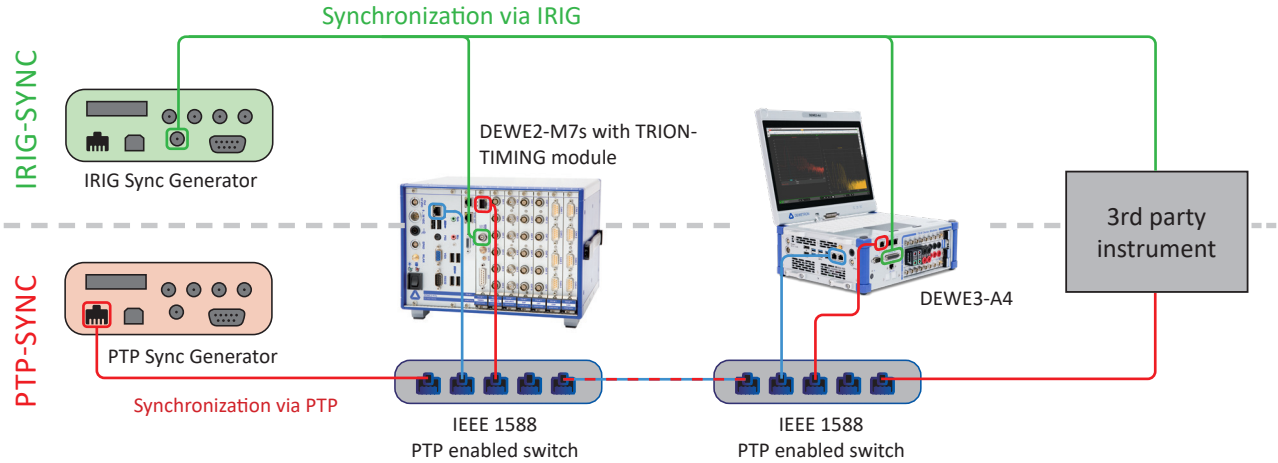

Fig. 30: PTP sync / IRIG sync

WORKING WITH THE SYSTEM

GPS sync

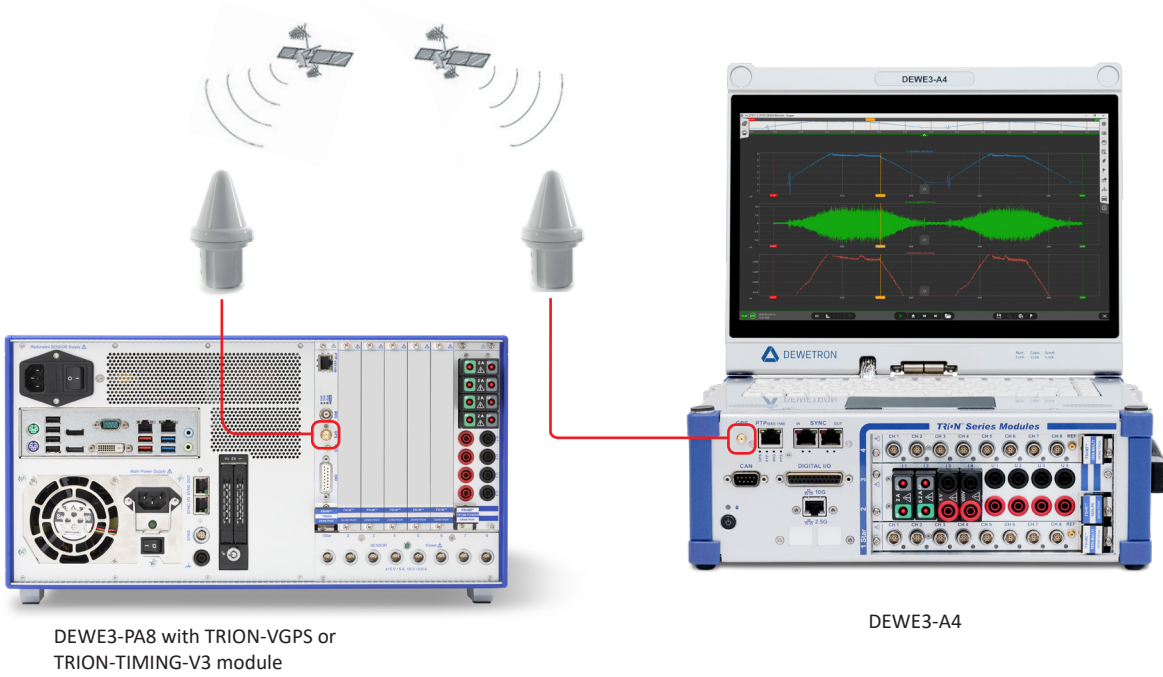

Fig. 31: GPS sync

Maintenance and service

The information in this section is designed for use by qualified service personal.

Service interval

Clean dust from the chassis exterior/interior and exchange filter foam based on the operating environment.

Actions	On demand	At least once a year	Every 5 years
Clean dust from chassis exterior/interior	Depending on environmental conditions	x	-
Clean filters	Depending on environmental conditions	x	-
Calibrate TRION modules	-	x	-
Change CPU fan	-	-	x
Change chassis fan	-	-	x
Change CMOS battery	-	-	x
Change SSD	Depending on SSD health status	-	x

Fig. 32: Service intervals

Cleaning the system

- ▶ Clean surface of the chassis with dry lint-free cloth.
- ▶ Use a dry velocity stream of air to clean the chassis interior.

Do not use harsh chemical cleaning agents.

NOTICE



Many components within the chassis are sensitive to static discharge damage. Always wear a ground wrist strap and service the unit only in static-free environment.

WARNING



Risk of injury

Disconnect all cables before servicing the unit.



MAINTENANCE AND SERVICE

Cleaning the filter pad

Requirements

- ▶ TORX T10 screw driver

WARNING



Do not attempt to remove filter covering plate when in operation.
Power off the instrument and disconnect the device from the power supply first.
Any voltage over 50 V connected to the modules must also be terminated.

Procedure

1. Switch-off the instrument and disconnect any high-voltage sensors/connectors.
2. Loosen 6 screws of the fan cover plate at the right side of the system using a TORX T10 screwdriver.



3. Grab the carrying handle and remove the covering plate.



4. Remove the filter pads.



5. Clean the filterpads with a dry velocity stream of air.
6. Reinsert the cleaned filter pads and gently tap them.



7. Remount the covering plate by tightening the 6 screws using a TORX T10 screwdriver.

NOTICE Do not switch on the instrument before the covering plate has not been fully reattached.

The filter pad cleaning procedure is now finished.

System recovery

For more information regarding a total recovery refer to the corresponding total recovery technical reference manual shipped with your DEWE3 system.

Updates

Windows and antivirus/security software

Before installing Windows software updates consult with DEWETRON for compatibility guidance. Also keep in mind that the use of any antivirus or other security software may slow down your system and may cause data loss.

Software updates

NOTICE

The system BIOS is protected by password. Any change in the BIOS may cause a system crash. When the system is booting, do not press ESC-button on keyboard. This may clear the BIOS settings and cause system faults.

Any change in the file structure as deleting or adding files or directories might cause a system crash.

Before installing software updates contact DEWETRON or your local distributor. Use only software packages which are released by DEWETRON. Further information is also available in the Internet (<http://www.dewetron.com>).

After power off the system wait at least 10 seconds before switching the system on again. Otherwise the system may not boot correct. This prolongs also the life of all system components.

Training

DEWETRON offers training at various offices around the world several times each year. DEWETRON headquarters in Austria have a very large and professional conference and seminar center, where training classes are conducted on a regular basis starting with sensors and signal conditioning, A/D technology and software operation.

Dewetron Inc. in the USA also has a dedicated training facility connected to its headquarters, located in Rhode Island.

For more information about training services visit <https://www.dewetron.com/academy>.

Calibration

Every instrument needs to be calibrated at regular intervals. The standard norm across nearly every industry is annual calibration. Before your DEWETRON data acquisition system is delivered, it is calibrated at our DEWETRON headquarter. Each of this system is delivered with a certificate of compliance with our published specifications. Detailed calibration reports from our calibration system are available for purchase with each order. We retain them for at least one year, so calibration reports can be purchased for up to one year after your system was delivered.

MAINTENANCE AND SERVICE

Support

DEWETRON has a team of people ready to assist you if you have any questions or any technical difficulties regarding the system. For any support contact your local distributor first or DEWETRON directly.

For Asia and Europe contact:

DEWETRON GmbH
Parkring 4
8074 Grambach
AUSTRIA
Tel.: +43 316 3070
Fax: +43 316 3070-90
E-Mail: support@dewetron.com
Web: http://www.dewetron.com

The telephone hotline is available
Monday to Friday between
08:00 and 17:00 CET (GMT +1:00).

For the Americas contact:

DEWETRON Inc. (HQ USA)
2850 South County Trail, Unit 1
East Greenwich, RI 02818
USA
Tel.: +1 401 284 3750
Toll-free: +1 866 598 3393
Fax: +1 401 284 3750
Email: support@dewetron.com
Web: http://www.dewetron.com

The telephone hotline is available
Monday to Friday between
08:00 and 16:30 EST

Service and repairs

We are very sorry that your DEWETRON system is not operating properly. Our team is here to ensure that your DEWETRON product is returned to peak performance as quickly as possible.

Help us to provide you with the best support by following the RMA policy.

Some problems can be solved remotely by our support team. To facilitate a quicker resolution to the problem and save unnecessary shipping costs, we ask you to first have your problem investigated by our technical support before sending your product. Contact details for our support can be found on our website. Describe the error accurately and with as much detail as possible. This helps expedite the repair process.

If a repair is necessary, complete our online [RMA form](#). You will then receive an RMA (Return Material Authorization) number and detailed instructions that identify where to ship the damaged product.

Products arriving at our repair department without RMA require follow-up calls and investigation, which lead to a longer turnaround. Only the team of DEWETRON is allowed to perform any kinds of repairs to your system to assure a safe and proper operation in future.

INFORMATION

Only the team of DEWETRON is allowed to perform any kinds of repairs to your system to assure a safe and proper operation in future. For information regarding service and repairs contact your local distributor first or DEWETRON directly.

INFORMATION

Any spare parts (screws, backplanes, cables etc.) must be obtained from DEWETRON only.

Letter of volatility

The data storage capacity of the DEWE3-A4 can be extended by the SSD-256V-1T-EL option to 1 TB. The following chart corresponds to the memory types that are used within the DEWE3-A4 systems.

Volatile memory

Type	Size	User modifiable	Function	Process to delete
Innodisk M4SS, DDR4 SODIMM	16 GB module (16x 1 GB chips)	Yes	RAM	Power off
Intel i7 6820EQ, cache	8 MB	No	Cache	Power off
Chassis Controller DDR3	512 MB	Yes	Buffer for measurement data	Power Off

Tab. 19: Volatile memory

Non-volatile memory

Type	Size	User modifiable	Function	Process to delete
Innodisk 3MG2-P, Solid State Drive	256 GB + cache	Yes	Main drive for operating system, programs and drivers	Remove drive or DoD 5220.22-M wiping
Innodisk 3MG2-P, Solid State Drive	1 TB + cache	Yes	Data drive	Remove drive or DoD 5220.22-M wiping
BIOS Chip EEPROM	16 MB	Yes	BIOS Settings, firmware	Factory reset
EC EEPROM	64 kB	No	Fan control settings, Firmware	n.a.
Display EEPROM	8 kB	No	LVDS Display Settings	n.a.
Flash	16 MB	Read only, yes under certain circumstances	Chassis controller firmware	DEWETRON Explorer firmware update
EEPROM	8 kB	No	PTP configuration	n.a.

Tab. 20: Non-volatile memory

▼

CERTIFICATE OF CONFORMITY

CE certificate of conformity



Manufacturer

DEWETRON GmbH

Address

Parkring 4
8074 Grambach, Austria
Tel.: +43 316 3070-0
Fax: +43 316 3070-90
Email: sales@dewetron.com
<http://www.dewetron.com>

Name of product

DEWE3-A4

Kind of product

Data acquisition instrument

The product meets the regulations of the following EC-directives:

2014/35/EU

Directive of the European Parliament and of the Council of 26 February 2014 on the harmonization of the laws of the Member States relating to the making available on the market of electrical equipment designed for use within certain voltage limits

2014/30/EU

Directive of the European Parliament and of the Council of 26 February 2014 on the harmonisation of the laws of the Member States relating to electromagnetic compatibility (recast)

The accordance is proved by the observance of the following standards:

L V E M C	Safety	IEC 61010-1:2010, Pol. deg. 2	
	Emissions	EN 61000-6-4	EN 55011 Class B
	Immunity	EN 61000-6-2	Group standard

Graz, March 2, 2020

Place / Date of the CE-marking

Ing. Thomas Propst / Manager Total Quality

CERTIFICATE OF CONFORMITY

Conformity to IEC 61000-4-30

Manufacturer DEWETRON GmbH
Address Parkring 4
8074 Grambach, Austria
Tel.: +43 316 3070-0
Fax: +43 316 3070-90
Email: sales@dewetron.com
http://www.dewetron.com

This certificate has been issued as a result of an assessment of the performance of the models listed below as to their conformity with the requirements of IEC 61000-4-30:2008 Class A, Electromagnetic compatibility (EMC) Part 4-30: Testing and measurement techniques – Power quality measurement methods.

Instruments **DEWE2 series (all devices)** **TRIONet**
DEWE3 series (all devices) **TRIONet3**
in combination with

Amplifiers **TRION-1820-POWER-4** **TRION-1810-HV-8**
TRION3-1810M-POWER-4 **TRION3-SUB-8 with SUB-600V**
and

Software **OXYGEN with OPT-POWER-BASIC and OPT-POWER-ADV since version 2.3**

Standard	Parameter	IEC section	Referring to	Class	Comment
IEC 61000-4-30	Power frequency	5.1	-	A	a)
	Magnitude of supply voltage	5.2	-	A	a)
	Flicker	5.3	61000-4-15	A	b)
	Supply voltage unbalance	5.7	-	A	a)
	Voltage harmonics	5.8	61000-4-7	A	c), d)
	Voltage interharmonics	5.9	61000-4-7	A	d)

General notice: no synchronisation to UTC 10 minute tick

a) 10/12 period values only with setting "Max. update rate" = 190 ms

b) For U_{din} in range of 60 V to 690 V

c) Only with grouping setting = "Type 1"; no smoothing with LP filter

d) For nominal value of 5 A, use SUB-CUR-20A; for currents above use external current sensor

On the basis of the evidence presented, the above products conform to the requirements of IEC 61000-4-30:2008 (Edition 2) Class A, Electromagnetic compatibility (EMC) Part 4-30: Testing and measurement techniques – Power quality measurement methods:

Graz, August 10, 2023

Place / date of issue



Ing. Thomas Propst / Manager Total Quality