

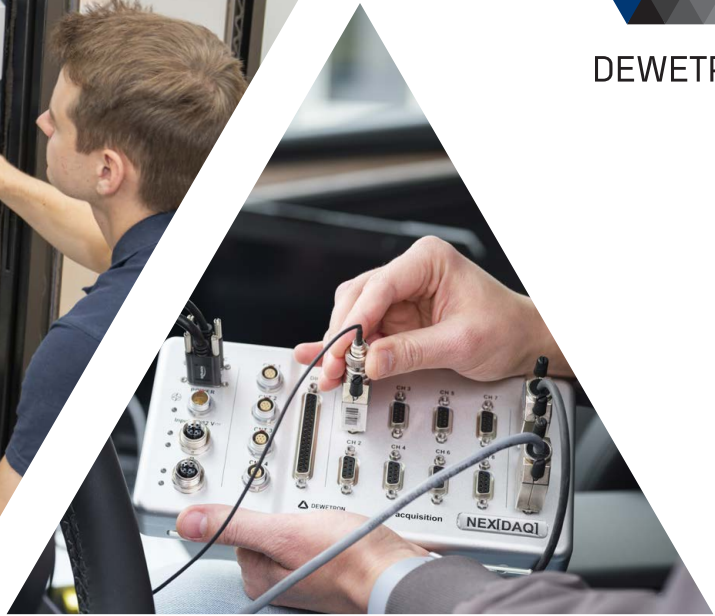

DEWETRON

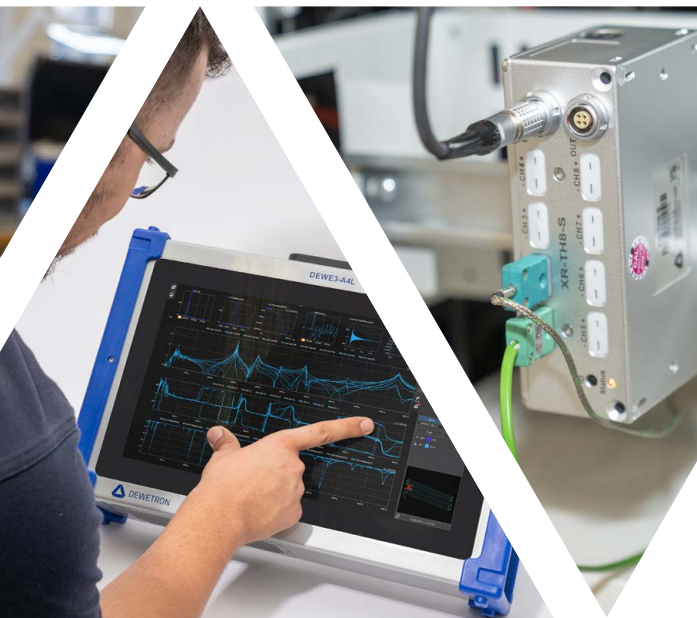

# 데베트론 제품소개서



# WE ARE PASSIONATE ABOUT WHAT WE DO

우리는 우리가 하는 일을 사랑합니다. 그 열정은 테스트 및 계측 시스템의 품질과 고객 만족에서 확인할 수 있습니다.

*“항상 해결책을 찾기 위해 노력해주시고, 기술적으로 어려운 상황에서도 어떻게든 도움을 주시려는 점이 인상적입니다.”*  
- Framatome -

*“조달 과정의 어려움 속에서도 프로젝트를 계속 진행할 수 있도록 큰 지원을 해주셔서 감사합니다. DEWETRON을 선택한 것이 정말 잘한 결정이라고 느끼고 있습니다.”*  
- Siemens Amberg -

*“기존 소프트웨어에서는 많은 편법과 번거로운 작업이 필요했지만, OXYGEN에서는 그런 과정이 전혀 필요하지 않습니다. 처음부터 끝까지 매우 잘 설계되어 있습니다.”*  
- IABG -

고객의 개발과 검증 업무는 계측 시스템의 신뢰성과 정확도에 달려 있다는 점을 잘 알고 있습니다. 그래서 우리는 최고의 품질 기준에 따라 제품을 개발하고 있으며, 1989년부터 신뢰할 수 있는 고정밀 계측 데이터를 제공해오고 있습니다. 우리는 오스트리아 품질에 대한 자부심을 가지고 있습니다.

THE MEASURABLE DIFFERENCE.

Scan to download  
this Product Guide

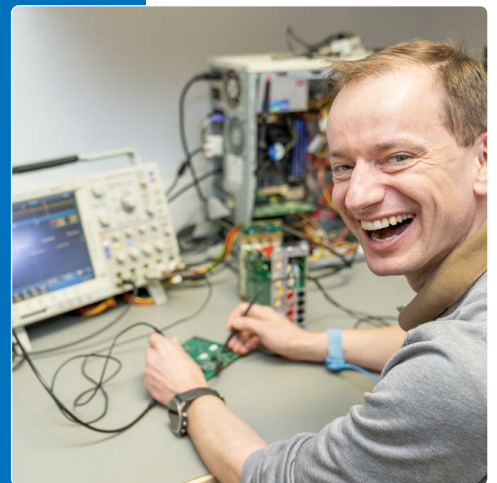
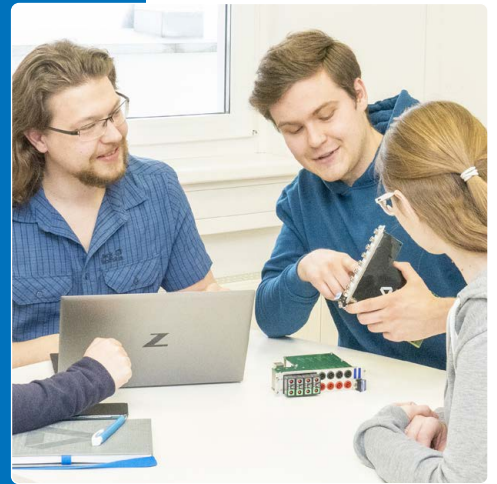
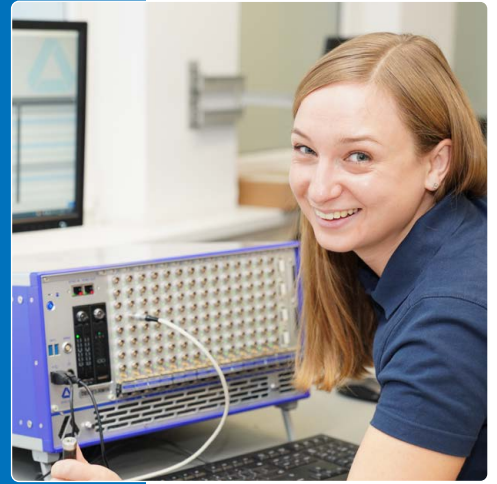

# CONTENTS

PORTFOLIO & SERVICES.....	4
HIGHEST QUALITY MADE IN AUSTRIA.....	6
SYSTEM OVERVIEW.....	7
TRION & <b>TRION3</b> MODULES.....	8
ANALOG OUTPUT.....	10
POWER ANALYSIS.....	12
LITE[PA].....	14
TEST STAND INTEGRATION.....	15
ALL-IN-ONE SYSTEMS.....	16
MAINFRAME SYSTEMS.....	17
RACK-MOUNT MAINFRAMES.....	18
TRIONet3 FRONT-END.....	19
RUGGED & COMPACT: NEX[DAQ].....	20
PURE RECORDING: PU[REC].....	21
RUGGED CHANNEL EXPANSIONS: XR.....	22
MSI SENSOR ADAPTER.....	23
SYNCHRONIZATION.....	24
ANALOG SIGNAL CONDITIONING.....	26
OXYGEN MEASUREMENT SOFTWARE.....	27
SDK FOR PROGRAMMERS.....	33
LABVIEW™ INTEGRATION.....	35
CUSTOMER CARE CENTER.....	36
ELECTRICAL POWER & NVH.....	38
ACCESSORIES.....	39

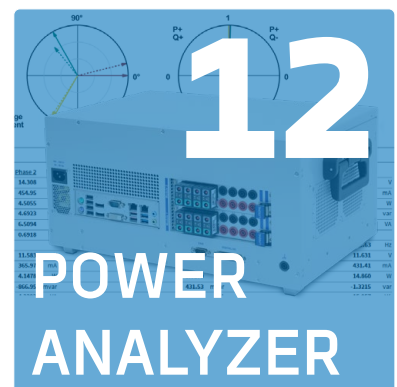
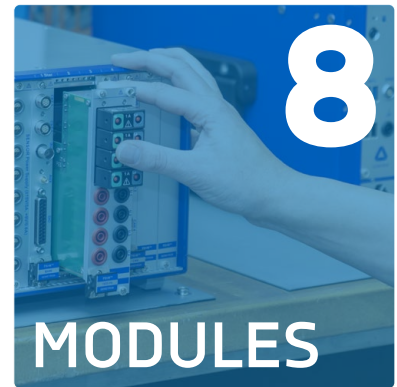

# PORTFOLIO & SERVICES

RELIABLE and PRECISE measurement data play an essential role in your daily business? The requirements in your CHALLENGING test and measurement tasks change frequently and you need to be very FLEXIBLE? The DAQ hardware and even the used software should be CUSTOMIZABLE and EASY TO USE?

We listen to our customers and offer MODULAR DAQ SOLUTIONS – you have the choice.

## CONFIGURE YOUR INDIVIDUAL DAQ SOLUTION

CHASSIS



MODULES



SOFTWARE



DEWE3

DIFFERENT CHASSIS LIKE ALL-IN-ONE WITH DISPLAY, FRONT-END, 19" RACK-MOUNT...



TRION(3)

USER-EXCHANGEABLE TRION(3) MODULES FOR ALL INPUT SIGNALS; UP TO 10 MS/S



OXYGEN

OXYGEN MEASUREMENT SOFTWARE: POWER ANALYSIS, ORDER ANALYSIS, FFT...

## MEASUREMENT CHAIN OF ANALOG SIGNALS

TRION(3) modules are the heart of every DEWETRON measurement system. The sensing of physical parameters such as vibrations, strains, noise, pressure, force, current etc. is usually carried out with sensors that output analog signals. TRION(3) modules take over the precise signal conditioning, digitization and filtering of these signals and make the data available for further processing and storage.

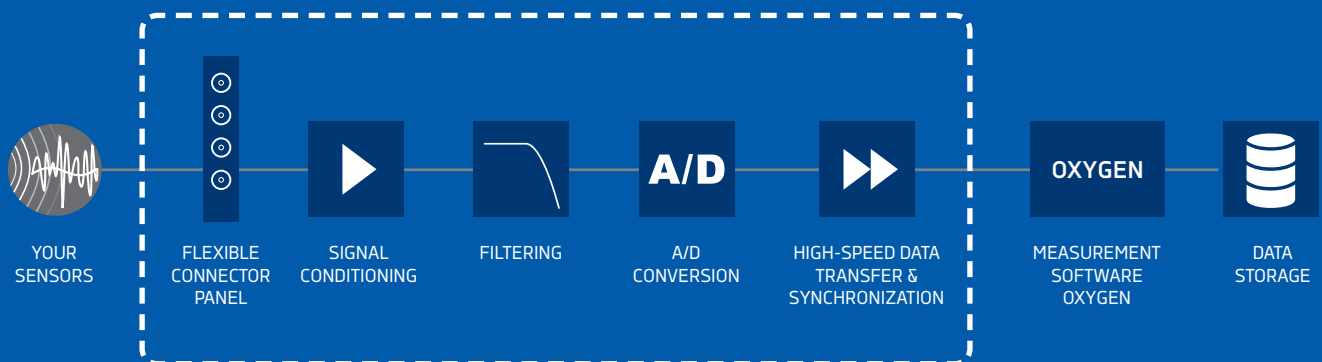

SENSOR

TRION(3) MEASUREMENT MODULE

DAQ SYSTEM WITH SOFTWARE

In addition, TRION(3) modules provide strong and stable sensor excitation and various types of industrial connectors, making it easy to connect every sensor!

## YOUR DAQ SYSTEM



FOR EXAMPLE: DEWE3-A4, DEWE3-PA8 POWER ANALYZER, DEWE3-A4L, TRIONet3, DEWE3-M4, DEWE3-RM16, DEWE3-PA8-RM

## CUSTOMER CARE CENTER



CALIBRATION  
(ISO 17025)



FIRST LEVEL  
SUPPORT



SYSTEM  
UPGRADE



SECOND  
LEVEL  
SUPPORT



5-YEAR  
WARRANTY  
EXTENSION



DEWETRON  
TRAINING  
ACADEMY



REPAIR



MAINTENANCE



RENTAL  
SERVICE

## PROCESSED SIGNALS IN 100 % SYNC



VOLTAGE



CURRENT



POWER



THERMO-  
COUPLE



POTENTIO-  
METER



RTD



IEPE  
(VIBRATION)



BRIDGE



CHARGE



COUNTER



VIDEO



SOUND



GPS SYNC



IRIG SYNC



PTP SYNC



PPS SYNC



IMU



SENSOR  
ADAPTER



DIGITAL  
INPUT



DIGITAL I/O



ANALOG  
OUTPUT



LVDT



CAN-BUS



CAN-BUS



SCPI



XCP



ETHERCAT



FLEXRAY



ARINC-BUS



MIL-BUS

# HIGHEST QUALITY MADE IN AUSTRIA

Our commitment to Total Quality Management is based on understanding what is important for the success of our customers. It starts with the definition of the technical specification, covers development, production, quality control, shipment and ends with support and service of our systems during operation. All DEWETRON products go through a tough product qualification phase before being approved for the market. With our quality control methods, we can assure you the highest reliability so that the products fulfill their function over a long period of time.

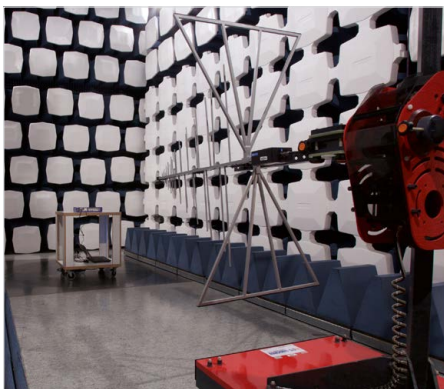

## RADIATED IMMUNITY

We test the immunity of our devices against radiated disturbances by using a generator and an antenna to create a strong modulated, electromagnetic field. Testing is conducted in a special anechoic test chamber, in a certified contract lab.



## OPERATING & STORING TEMPERATURE, HUMIDITY

We use climate chambers to validate our environmental specifications (e.g. temperature ranges of -40 to +70 °C). So we can ensure, that our DEWETRON products can be used on a Swedish ice lake as well as in Nevada's desert.



## ESD IMMUNITY (ELECTROSTATIC DISCHARGE)

If an electrostatically charged object touches a conductive part of a device, an unwanted, sudden flow of electricity is induced, which can destroy electrical circuits. We simulate this with our ESD (electrostatic discharge) gun.



## THERMAL TESTING

We use thermal testing to detect any potential hotspot, component failures during operation, or other issues that could lead to unexpected performance.

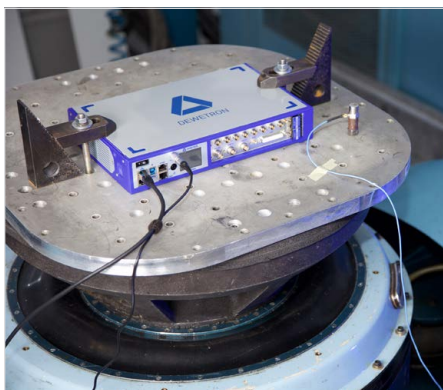

## MECHANICAL & SEISMIC SHOCK, VIBRATION

We test all of our devices on electrodynamic shakers to simulate vibrations and impacts during operation and transport.



## BURST/SURGE IMMUNITY, VOLTAGE DIPS

We simulate voltage dips, power interruptions, surge and burst phenomena during our product qualification tests using special generators.

# SYSTEM OVERVIEW



## POWER ANALYZER

- > Up to 16 power phases
- > 0.03 % measurement error (1 to 1000 Hz)
- > Additional, mixed signals
- > Integrated redundant current transducer supply

Consisting of these parts:



## ALL-IN-ONE SYSTEMS

- > Built-in display
- > Compact and flexible configuration
- > Powerful PC inside for fast online displays and analysis
- > Battery power option

Consisting of these parts:



## MAINFRAME SYSTEMS

- > Powerful PC inside for fast online displays and analysis
- > Can be used with external monitor
- > The ideal solution for installations in a 19" rack

Consisting of these parts:



## FRONT-END SYSTEMS

- > Used with an external computer
- > Ideal for small channel count application
- > Fully synchronized expansion for all-in-one or mainframes
- > Multiple units can be daisy-chained
- > Connected via USB3.0 or GBit-Ethernet

Consisting of these parts:

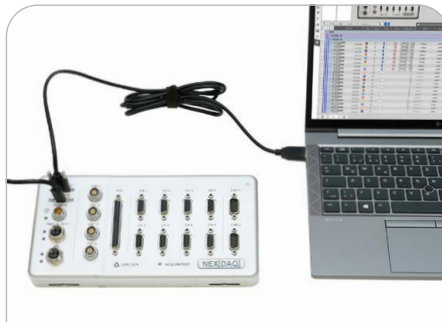

## DATA LOGGER NEX[DAQ]

- > Used with an external computer
- > Rugged & compact data logger
- > IP67 rating
- > 8 measurement channels
- > Channel count expandable via XR modules or MSI sensor adapter

Consisting of these parts:



## SIGNAL CONDITIONING

- > Stand-alone analog signal conditioning
- > Front-ends for existing recorders, A/D boards ...
- > Up to 300 kHz bandwidth

Consisting of these parts:



LEGEND:



Signal conditioning amplifiers



A/D conversion



Built-in computer



Display



# TRION & TRION3 MODULES

Choose from our various TRION(3) signal conditioning modules to measure analog signals from any sensor absolute synchronously. Enjoy maximum flexibility with these user-exchangeable modules featuring A/D conversion on each channel and anti-aliasing filters.

ANALOG MODULES			CHANNELS	SAMPLE RATE PER CHANNEL	RESOLUTION	ISOLATION	CONNECTOR TYPES	
NEW	TRION3-1850-MULTI <sup>1)</sup>	V <sub>100</sub>	I	4 or 8	1850: 5 MS/s 1820: 2 MS/s 1802: 200 kS/s	24-bit  >2 MS/s: 18-bit	yes	4 D-SUB or 8 LEMO 0B
	TRION3-1820-MULTI <sup>1)</sup>	CAN	MSI					
	TRION3-1802-MULTI <sup>1)</sup>	009						
	TRION-2402-MULTI	V <sub>100</sub> CAN	I MSI	8	200 kS/s	24-bit	yes	8 LEMO 0B
	TRION3-1810-HV <sup>1)2)</sup>	V <sub>1000</sub>	I	4 to 8	1 MS/s	24-bit	yes	4 x Safety banana, 4x depend. on sub-modules
	TRION3-1810-SUB-8 <sup>1)2)3)</sup> Carrier board for up to 8 sub-modules	V <sub>600</sub>	I	8	1 MS/s	Depending on 8 x sub-modules		
	TRION3-1810M-SUB-8 <sup>1)2)3)</sup> Carrier board for up to 8 sub-modules	V <sub>600</sub>	I	8	10 MS/s	Depending on 8 x sub-modules		
	TRION-2402-dSTG	V <sub>10</sub>	I	8	200 kS/s	24-bit	no	8 LEMO 0B, 8 RJ45
NEW	TRION3-2402-ACC <sup>1)</sup>	V <sub>100</sub>	I	6	200 kS/s	24-bit	yes	6 BNC
NEW	TRION3-2402-LV <sup>1)</sup>	V <sub>100</sub>	I	6	200 kS/s	24-bit	yes	6 BNC
NEW	TRION3-2420-ACC <sup>1)</sup>	V <sub>100</sub>	I	6	2 MS/s	24-bit	yes	6 BNC
NEW	TRION3-2420-LV <sup>1)</sup>	V <sub>100</sub>	I	6	2 MS/s	24-bit	yes	6 BNC
	TRION3-1802-dLV <sup>1)</sup>	V <sub>10</sub>	009	16 or 32	200 kS/s 100 kS/s	18-bit 24-bit	no	D-SUB
	TRION3-1600-dLV <sup>1)</sup>	V <sub>10</sub>	009	16 or 32	20 kS/s	16-bit	no	D-SUB

<sup>1)</sup> All TRION3 modules require a DEWE3 chassis

<sup>2)</sup> These modules occupy 2 TRION(3) slots

<sup>3)</sup> Max. sample rate limit, also depending on sub-modules (see page 13)

DIGITAL MODULES		CHANNELS	SAMPLE RATE PER CHANNEL	ISOLATION	FEATURES
TRION-CNT		6	2 MS/s	yes	6 advanced counter
TRION-DI-48		48	3 MS/s	yes	48 high-speed digital IN
TRION-BASE		-	2 MS/s	no	Basic IO card with simple IRIG sync and 2 counter
TRION-VGPS-V3		-	2 MS/s	no	100 Hz GNSS receiver for automotive applications
TRION-TIMING-V3		-	2 MS/s	no	Applies precision absolute time to measured data
<b>NEW</b> TRION3-CAN-FD <sup>1)</sup>		4	Up to 8 MBit	yes	D-SUB
TRION-ARINC429		4 or 16	-	no	Decoding of ARINC 429, export of decoded signals
TRION-MIL1553		1 or 4	-	no	Decoding of MIL-STD-1553, export of decoded signals
TRION-EtherCAT-1-SLAVE		100	500 S/s	no	Measurement data output

<sup>1)</sup> All TRION3 modules require a DEWE3 chassis

POWER MODULES		CHANNELS	SAMPLE RATE PER CHANNEL	RESOLUTION	ISOLATION	CONNECTOR TYPES
TRION3-1810M-POWER <sup>1) 2)</sup>		8 (4 U / 4 I)	10 MS/s	18-bit	yes	4 x Safety banana, 4x depend. on sub-modules
TRION3-1820-POWER <sup>1) 2)</sup>		8 (4 U / 4 I)	2 MS/s	18-bit	yes	4 x Safety banana, 4x depend. on sub-modules
TRION3-1810-HV <sup>1) 2)</sup>		8 (4 U / 4 I)	1 MS/s	24-bit	yes	4 x Safety banana, 4x depend. on sub-modules
TRION3-1810-SUB-8 <sup>1) 2) 3)</sup> Carrier board for up to 8 sub-modules	<i>Inputs depending on used sub-modules</i>	8	1 MS/s	Depending on 8 x sub-modules		
TRION3-1810M-SUB-8 <sup>1) 2) 3)</sup> Carrier board for up to 8 sub-modules	<i>Inputs depending on used sub-modules</i>	8	10 MS/s	Depending on 8 x sub-modules		

<sup>1)</sup> All TRION3 modules require a DEWE3 chassis

<sup>2)</sup> These modules occupy 2 TRION(3) slots

<sup>3)</sup> Max. sample rate limit, also depending on sub-modules (see page 13)

ANALOG OUTPUT MODULES		CHANNELS	SAMPLE RATE PER CHANNEL	RESOLUTION	ISOLATION	CONNECTOR TYPES
<b>NEW</b> TRION3-1850-MULTI-AOUT <sup>1) 2)</sup>		IN: 8 OUT: 8	IN: 5 MS/s OUT: 2.5 MS/s	IN: 24-bit OUT: 16-bit or 32-bit	IN: yes OUT: yes	IN: LEMO 0B OUT: D-SUB, BNC
TRION3-1820-MULTI-AOUT <sup>1) 2)</sup>		IN: 8 OUT: 8	IN: 2 MS/s OUT: 2.5 MS/s	IN: 24-bit OUT: 16-bit or 32-bit	IN: yes OUT: yes	IN: LEMO 0B OUT: D-SUB, BNC
<b>NEW</b> TRION3-2420-ACC-AOUT <sup>1) 2)</sup>		IN: 6 OUT: 8	IN: 2 MS/s OUT: 2.5 MS/s	IN: 24-bit OUT: 16-bit or 32-bit	IN: yes OUT: yes	IN: BNC OUT: D-SUB, BNC
<b>NEW</b> TRION3-2420-LV-AOUT <sup>1) 2)</sup>		IN: 6 OUT: 8	IN: 2 MS/s OUT: 2.5 MS/s	IN: 24-bit OUT: 16-bit or 32-bit	IN: yes OUT: yes	IN: BNC OUT: D-SUB, BNC
TRION3-AOUT <sup>1)</sup>		OUT: 8	OUT: 2.5 MS/s	OUT: 16-bit or 32-bit	OUT: yes	OUT: D-SUB, BNC

<sup>1)</sup> All TRION3 modules require a DEWE3 chassis

<sup>2)</sup> These modules occupy 2 TRION(3) slots

## MAXIMUM FLEXIBILITY WITH PLUG&PLAY TRION(3) MODULES

You are absolutely flexible with the user-exchangeable TRION(3) modules: Choose your suitable TRION(3) modules, plug them into your DEWE3 DAQ system, turn the system on and get to work. The modules are automatically identified and configured within the software as soon as it is launched.

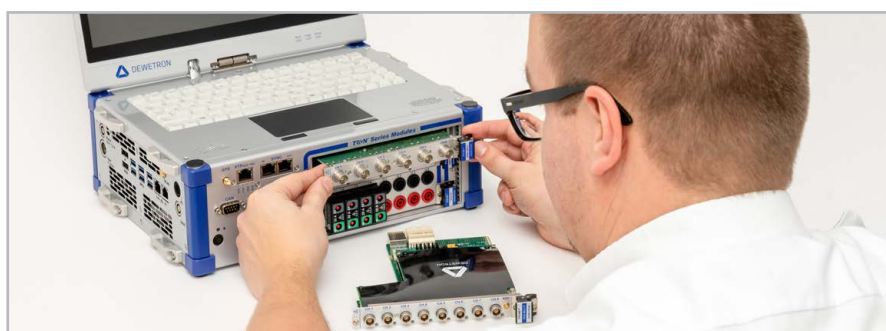

# ANALOG OUTPUT

The TRION3-x-AOUT modules offer several ways to output analog signals for different use cases such as signal conditioning, waveform generation or playback of recorded data. In particular, true 3-way isolation, bandwidth of up to 600 kHz for the analog output and the industry-leading dynamics, which is achieved by 32-bit D/A-converters, must be emphasized.



## UNIVERSAL SIGNAL CONDITIONING & PROCESSING

### ANALOG INPUT SIGNALS

- VOLTAGE
- CURRENT
- IEPE<sup>®</sup> (VIBRATION)
- BRIDGE
- RTD
- POTENTIOMETER
- COUNTER INPUTS
- CAN-BUS

### ISOLATED CONDITIONED OUTPUT SIGNALS

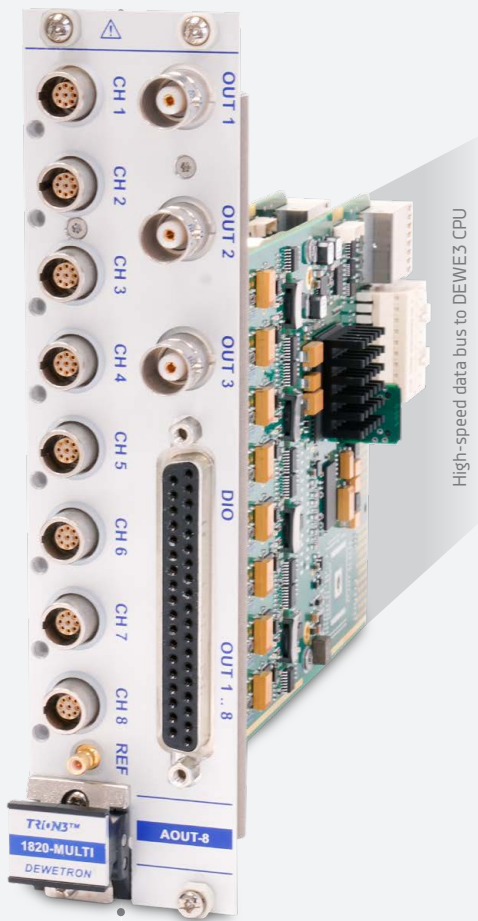

### OUTPUT SIGNALS

- ±5 V (e.g. 2 mV/V  $\hat{=}$  ±5 V)
- ±10 V
- 0 - 5 V
- 0 - 10 V
- ±30 mA
- 0 - 30 mA

### REAL-TIME SIGNAL PROCESSING

- > Actual value
- > Average
- > RMS
- > MATH (A+B, A-B, AxB)

### SIGNAL GENERATION

- > Constant output
  - > Voltage up to ±10 V
  - > Current up to ±30 mA
- > Stream output
  - > Replay recorded data
  - > Live stream output
- > Function generator (sine, square, triangle, custom pattern)

## TRION3-18XX-MULTI-AOUT-8 MODULES

These universal signal conditioning & processing modules are typically used when it comes to mission-critical applications in which the sensor data must be stored redundantly. In these cases, after conditioning, digitization and filtering of the analog signals, the data is sent to the DEWE3 system's CPU via the PXIe interface as usual but additionally made available in parallel as analog signals for a second

digitization system. Since the signal processing and the analog output run independently, the measurement data is available to the redundant system at all times, even if there is a problem in the main system.

### ADDITIONAL FUNCTIONS

To make things even better, onboard real-time data processing is available, so the analog

output can represent not only the actual input value, but also average or RMS values. Simple calculations such as addition, subtraction or multiplication of channel data are also possible. All channels and values can be freely assigned to the available output connectors. Of course, these modules can also be used for signal generation or to replay recorded data files, see details at TRION3-AOUT-8.

ANALOG OUTPUT MODULES	CHANNELS	SAMPLE RATE PER CHANNEL	RESOLUTION	ISOLATION	CONNECTOR TYPES
<b>TRION3-1850-MULTI-AOUT</b> <sup>1) 2)</sup>	IN: 8 OUT: 8	IN: 5 MS/s OUT: 2.5 MS/s	IN: 24-bit OUT: 16-bit or 32-bit	IN: yes OUT: yes	IN: LEMO 0B OUT: D-SUB, BNC
<b>TRION3-1820-MULTI-AOUT</b> <sup>1) 2)</sup>	IN: 8 OUT: 8	IN: 2 MS/s OUT: 2.5 MS/s	IN: 24-bit OUT: 16-bit or 32-bit	IN: yes OUT: yes	IN: LEMO 0B OUT: D-SUB, BNC
<b>NEW</b> <b>TRION3-2420-ACC-AOUT-6</b> <sup>1) 2)</sup>	IN: 6 OUT: 8	IN: 2 MS/s OUT: 2.5 MS/s	IN: 24-bit OUT: 16-bit or 32-bit	IN: yes OUT: yes	IN: BNC OUT: D-SUB, BNC
<b>NEW</b> <b>TRION3-2420-LV-AOUT-6</b> <sup>1) 2)</sup>	IN: 6 OUT: 8	IN: 2 MS/s OUT: 2.5 MS/s	IN: 24-bit OUT: 16-bit or 32-bit	IN: yes OUT: yes	IN: BNC OUT: D-SUB, BNC
<b>TRION3-AOUT-8</b> <sup>1)</sup>	OUT: 8	OUT: 2.5 MS/s	OUT: 16-bit or 32-bit	OUT: yes	OUT: D-SUB, BNC

<sup>1)</sup> All TRION3 modules require a DEWE3 chassis

<sup>2)</sup> These modules occupy 2 TRION(3) slots

## POWERFUL SIGNAL GENERATION



### SIGNAL GENERATION

- > Constant output
  - > Voltage up to  $\pm 10$  V
  - > Current up to  $\pm 30$  mA
- > Stream output
  - > Replay recorded data
  - > Live stream output
- > Function generator (sine, square, triangle, custom pattern)

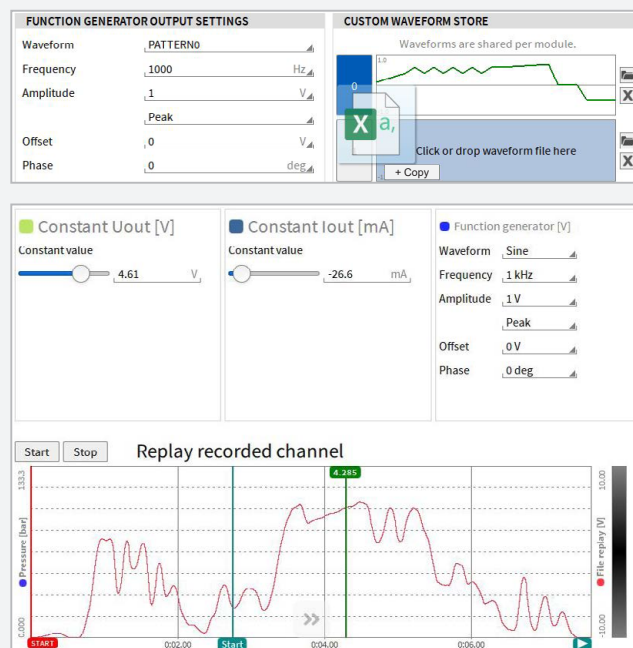

ARBITRARY WAVEFORM

## TRION3-AOUT-8 MODULES

The TRION3-AOUT-8 modules are very powerful signal generation modules. Each module provides 8 isolated output channels for voltage ( $\pm 5$  V,  $\pm 10$  V) or current ( $\pm 30$  mA) signals. The simplest application is the output of constant signals as default values or for simple control processes.

The FPGA based arbitrary waveform generator not only supports the generation of sine, square or triangle signals but also enables users to load their own custom patterns. The so called "stream output" mode enables the replay of recorded data channels as analog signals during a measurement. This simplifies reference curve generation during a measurement significantly.

## DAC MODES

Set the high-speed or high-resolution mode individually for every channel.

DAC MODE	HIGH-SPEED	HIGH-RESOLUTION
UPDATE RATE	2.5 MS/s	500 kS/s
DAC RESOLUTION	16-bit	32-bit
LATENCY	<5 $\mu$ s	<100 $\mu$ s
BANDWIDTH	600 kHz	70 kHz

# ADVANCED POWER ANALYZER

Build the power analyzer you need with our dedicated power modules.  
The perfect advanced power analyzer for every field of application.

- > Modular high-precision tailor-made power analyzer
- > Acquisition of additional inputs such as thermo-couple, IEPE, counter, CAN, GPS, video, SCPI, etc.
- > Up to 16 power phases (16 x U + 16 x I), expandable
- > Redundant, integrated current transducer supply
- > Various test bed integration possibilities
- > Remote configuration and control

EVERY DEWETRON SYSTEM CAN BE A POWER ANALYZER

**0.03 %**  
Measurement error

**10 MS**  
per second/  
per channel

**>16**  
Power phases  
expandable



PA-TRIONet3

**SMALLEST POWER ANALYZER**

DEWE3-PA8

**ALL-IN-ONE POWER ANALYZER**

DEWE3-PA8-RM

**STATIONARY POWER ANALYZER**

DEWE3-A4  
DEWE3-A8-PA

**PORTABLE POWER ANALYZER**

## ADVANCED POWER ANALYZER



POWER ANALYZER	DEWE3-PA8	DEWE3-PA8-RM	DEWE3-A8-PA
Slots for TRION / TRION3 modules	8 TRION / TRION3 (up to 16 phases)		
High-speed channel expansion	Add TRIONet3 or OXYGEN-NET		
Low-speed channel expansion	XR modules		
Data storage	1 TB Solid State Disk dedicated for data storage		
Optional data storage	Upgrade from 1 TB to 2 TB industrial grade, PCIe attached Solid State Disk (SSD-PCIe-1T-2T)		
Gapless storing rate	Typ. 1 GB/s	Typ. 1 GB/s	Typ. 800 MB/s
Display	11.6" multi-touch wide-screen, Full HD	No display	18.5" multi-touch wide-screen, Full HD
<b>POWER SUPPLY</b>			
Input voltage (max.)	90 to 264 V <sub>AC</sub>		
Sensor power supply	8 x (±15 V / +9 V)	8 x or 16 x (±15 V / +9 V)	8 x (±15 V / +9 V)
Integrated current transducer supply	Yes, with redundant supply		
<b>DIMENSIONS</b>			
Dimensions (W x D x H) without handle/feet	442 x 435 x 222 mm (5 u) (17.4 x 17.1 x 8.7 in.)	442 x 435 x 222 mm (5 u) (17.4 x 17.1 x 8.7 in.)	456 x 273 x 324.5 mm (18 x 10.8 x 12.8 in.)
Weight without modules and batteries	Typ. 14 kg (30.9 lb.)	Typ. 15.8 kg (34.8 lb.)	Typ. 15 kg (33 lb.)

Note: Please find the general chassis specifications for DEWE3-A4 on page 16 and PA-TRIONet3 on page 19.

# INDIVIDUAL INPUT CONFIGURATION WITH SUB-MODULES

We offer you a unique modularity: 4 slots of each power module or even 8 slots of the TRION3-1810(M)-SUB-8 can be equipped with different sub-modules. Choose between direct current measurement modules or voltage modules to connect almost any kind of current or voltage transducer.



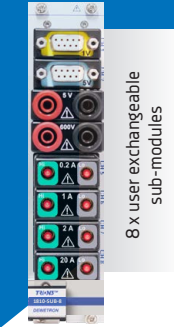





Create your individual input configurations with our sub-modules. They are user-exchangeable at any time and automatically detected. The calibration data is directly stored inside the sub-module.



TRION3-1810(M)-SUB-8



TRION(3)-18xx-POWER

SUB-MODULE		RANGE	SAFETY	BANDWIDTH	CONNECTOR	USER-EXCHANGEABLE
VOLTAGE	1 V module 	1 V <sub>RMS</sub> (±2 V <sub>PEAK</sub> )	Not isolated. Depending on connected clamp	5 MHz	D-SUB-9 socket	Yes
	5 V modules 	5 V <sub>RMS</sub> (±10 V <sub>PEAK</sub> )		5 MHz	D-SUB-9 socket	
	600 V module 	600 V <sub>RMS</sub> (±1500 V <sub>PEAK</sub> )		100 kHz	D-SUB-9 socket	
	XV module (seamless auto-range) 	600 V <sub>RMS</sub> (±1000 V <sub>PEAK</sub> ) 60 V <sub>RMS</sub> (±100 V <sub>PEAK</sub> ) 6 V <sub>RMS</sub> (±10 V <sub>PEAK</sub> ) 0.6 V <sub>RMS</sub> (±1 V <sub>PEAK</sub> )	CAT II 600 V, isolated	300 kHz	Safety banana	
CURRENT	Current transducer module 	1 A <sub>RMS</sub> (±2 A <sub>PEAK</sub> ) 0.5 A <sub>RMS</sub> (±1 A <sub>PEAK</sub> ) 0.25 A <sub>RMS</sub> (±0.5 A <sub>PEAK</sub> ) 0.1 A <sub>RMS</sub> (±0.2 A <sub>PEAK</sub> )	Not isolated. Depending on connected clamp	5 MHz	D-SUB-9 socket	Yes
	20 A module 	20 A <sub>RMS</sub> (±40 A <sub>PEAK</sub> )	CAT II 600 V, unfused	300 kHz	Safety banana (male)	
	2 A module 	2 A <sub>RMS</sub> (±4 A <sub>PEAK</sub> )				
	1 A module 	1 A <sub>RMS</sub> (±2 A <sub>PEAK</sub> )				
	0.2 A module 	0.2 A <sub>RMS</sub> (±0.4 A <sub>PEAK</sub> )				

FIXED HIGH-VOLTAGE INPUTS		RANGE	SAFETY	BANDWIDTH	CONNECTOR	USER-EXCHANGEABLE
Voltage input U1, U2, U3, U4 	1000 V <sub>RMS</sub> (±2000 V <sub>PEAK</sub> )	CAT IV 600 V / CAT III 1000 V	5 MHz	Safety banana	No	



## CURRENT TRANSDUCERS & CLAMPS

DEWETRON offers several solutions for current measurement from simple shunts to current clamps and high-precision zero flux transducers. There are versions for pure AC current which do not need any power supply and versions for DC and AC current which can be supplied from the DEWETRON instrument. Sensors requiring ±15 V or +9 V supply voltage can be powered directly. Therefore, sensors such as zero-flux transducers do not need an extra power supply.



# LITE[PA] STANDARD POWER ANALYZER

The LITE[PA] is a high-precision Power Analyzer with 4 or 8 phases for easy test stand integration. The tried and tested input modules guarantee highly precise measurement results and offer the user enough flexibility to use all common current sensors.

- > Most intuitive user interface for direct device operation, e.g. in laboratory use
- > Effortless data connection to host systems for remote controlled test stand or end-of-line applications

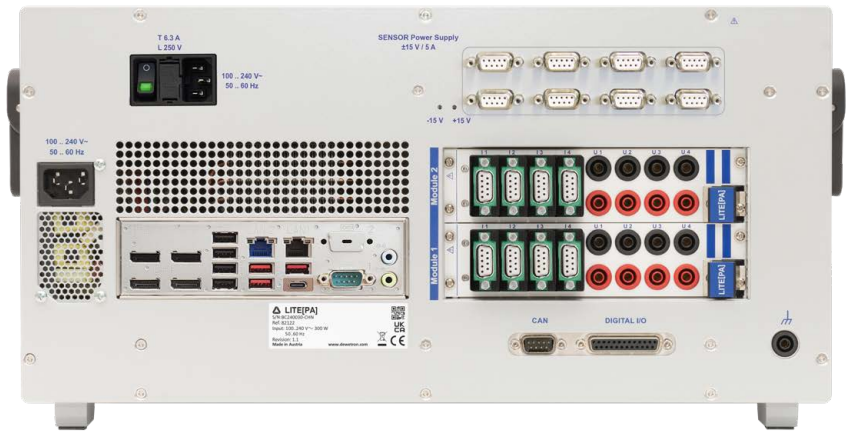

## INTERFACES

For easy data exchange, a variety of interfaces are offered. Inputs for speed and torque are available as standard and make the LITE[PA] suitable for testing electric motors.

- > Sub-modules for all current sensors
  - > Direct current up to 20 A<sub>RMS</sub> (±40 A<sub>PEAK</sub>)
- > 4 or 8 high-voltages up to ±2000 V<sub>PEAK</sub>
- > 8 x integrated current transducer supply
- > Ethernet for remote control & data exchange
  - > SCPI
  - > XCP
  - > UDP
- > CAN
  - > XR-TH8-S for temperatures
  - > Data transfer to host system
- > Digital I/O
  - > Speed
  - > Torque
  - > Frequency

LITE[PA] SPECIFICATIONS	
POWER accuracy 0.5 Hz to 1000 Hz (1 year)	0.04%
Number of phases	4 to 8
Sampling rate	Up to 10 MS/s
Resolution	≤2 MS/s: 24-bit; >2 MS/s: 18-bit
Bandwidth	Up to 5 MHz
Temperature measurement	Via XR-series modules
Internal storage capacity	256 GB
Display	11.6" multi-touch wide-screen display, full HD
Data visualization	Freely configurable and arrangeable, multiple view screens
Advanced data processing	Formulas, filters, statistics, FFT, etc. (online and post processing)
Reporting	Integrated reporting, many export data formats (*.xlsx, *.mat, *.dat, *.csv, etc.)
Data sharing and offline analysis	Unlimited free VIEW licenses for workgroups (for multiple analysis PCs)
Host system data connection	CAN, Ethernet (SCPI, XCP, UDP)
Power supply	90 .. 264 V <sub>AC</sub>
<b>NEW</b> Integrated current transducer supply	Yes, with independent power supply for sensors
Dimensions (W x D x H) without feet and handle	442 x 281 x 222 mm (17.4 x 11.1 x 8.7 in.); 5 u
Weight	4 ch: 9 kg (19.8 lb.); 8 ch: 9.5 kg (21 lb.)

## DATA CONNECTION TO HOST SYSTEMS

The LITE[PA] is ready to be easily integrated into a wide variety of host systems. In addition to the CAN-bus, the data can also be transmitted via Ethernet, with various protocols such as SCPI or XCP. The remote control is usually done via SCPI; extensive commands are available to e.g. load predefined setups, make trigger settings, etc.



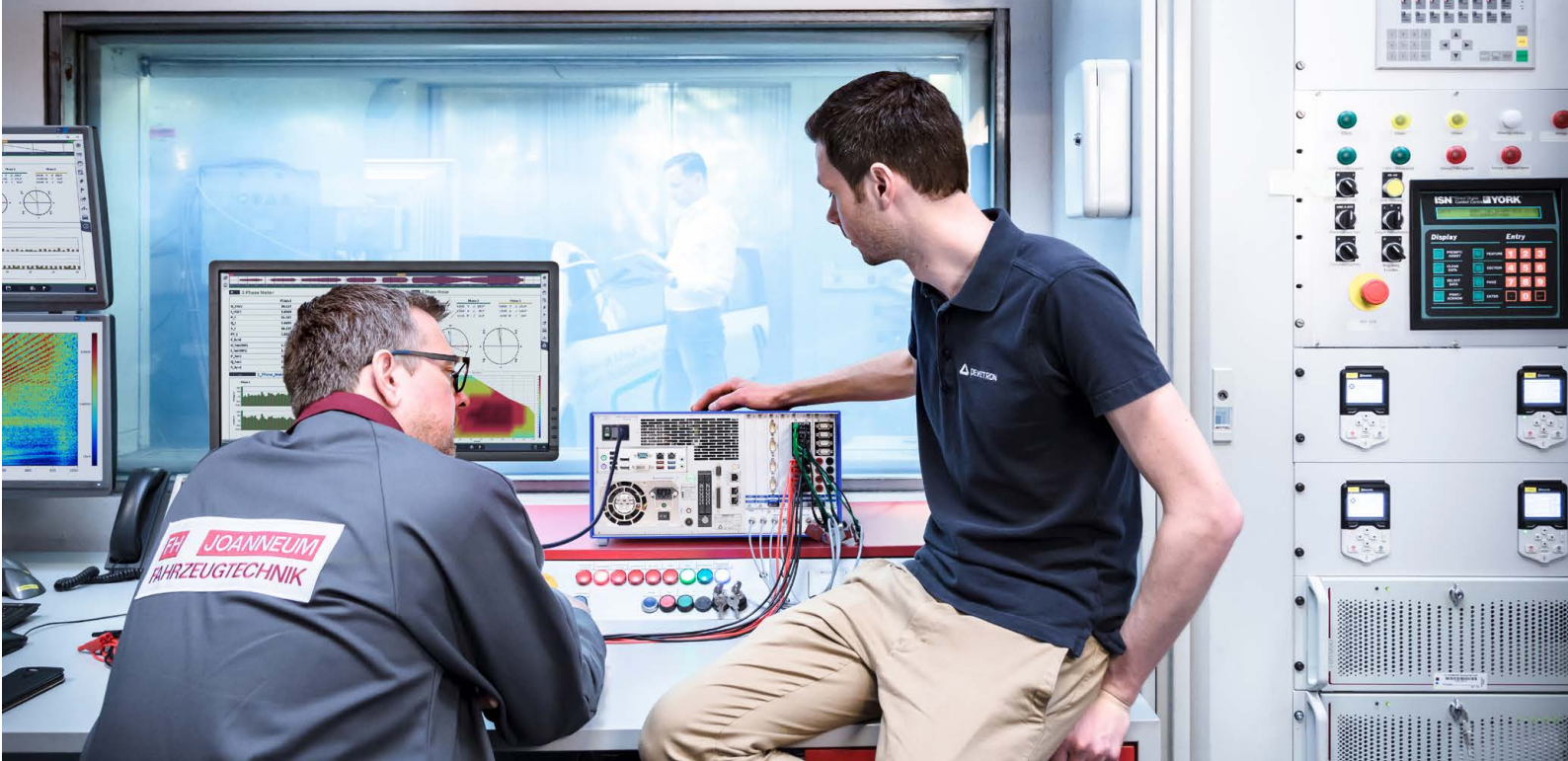

# TEST STAND INTEGRATION

Leading test stand manufacturers rely on the measurement data from DEWETRON when it comes to reliable testing of important and critical components. Our various interfaces guarantee you a simple integration.

## TEST STAND INTERFACES IN OXYGEN

Smart interface technology makes it easy to integrate DEWETRON power analyzers and measurement instruments into various test stand automation systems, such as PAtools® from NI. Depending on the system architecture of the test stand, DEWETRON systems are equipped with the right interface to ensure reliable data transmission, easy to use remote control and remote configuration, e.g. through TCP/IP-based protocols.

### EtherCAT INTERFACE

Typ. 100 ch  
Typ. 500 S/s per channel  
Data transfer & remote control

### SCPI OVER ETHERNET

Typ. 100 ch  
Up to 10 kS/s per channel  
Data transfer & advanced remote control

### XCP OVER ETHERNET

Typ. 20 ch  
Up to 2 MS/s per channel  
Interface to CANape and INCA

### CAN CAN-FD

Typ. 20 ch  
Typ. 100 S/s per channel

### DATA STREAM OVER ETHERNET

Typ. >100 ch  
Up to 2 MS/s per channel

### DMD READER

Library to import recorded data  
in 3rd party software

## DEDICATED REAL-TIME POWER ANALYSIS SOLUTION

DEWETRON offers a dedicated solution for latency critical tests and applications to turn your DEWE3 system into a real-time Power Analyzer

- > Calculation of cycle-by-cycle power values
- > Data output interface: Ethernet UDP or EtherCAT slave
- > Data output rate: 1 kHz
- > Typical I/O latency: 2 ms (max: 4 ms)

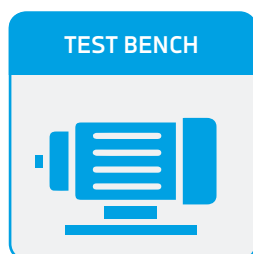

2 ms (max. 4 ms)  
Typical I/O latency



# ALL-IN-ONE SYSTEMS

- > Compact and flexible configuration
- > Convenient for mobile applications with built-in display
- > Powerful PC inside for fast online displays and analysis

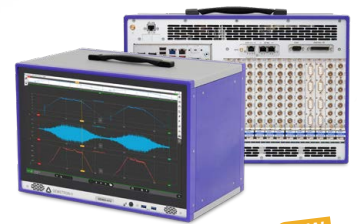
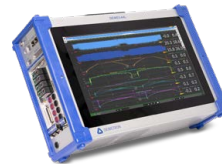

	DEWE3-A4	DEWE3-A4L	DEWE3-A8 / DEWE3-A12 <span style="color: orange; font-weight: bold;">NEW</span>
Slots for TRION / TRION3 modules	4 TRION / TRION3	4 TRION / TRION3	8 or 12 TRION / TRION3
High-speed channel expansion	Add TRIONet3 or OXYGEN-NET		
Low-speed channel expansion	XR modules		
Data storage	1 TB SSD dedicated for data storage 512 GB SSD for operating system and application software		
Optional data storage	Up to 4 TB SSD	Up to 4 TB SSD	Up to 2 TB SSD
Gapless storing rate	Typ. 400 MB/s	Typ. 400 MB/s	DEWE3-A8: typ. 800 MB/s DEWE3-A12: typ. 1 GB/s
Display	13.3" multi-touch wide-screen display, Full HD	15.6" multi-touch wide-screen display, Full HD	18.5" multi-touch wide-screen display, Full HD
<b>POWER SUPPLY</b>			
Input voltage (max.)	10 to 36 V <sub>DC</sub> isolated incl. external AC power supply	90 to 264 V <sub>AC</sub>	90 to 264 V <sub>AC</sub>
Option 1	Internal buffer battery for ~5 min operation	-	-
Option 2	External battery pack, 3 battery slots for ~1 h operation (DW3-UPS-DC)	-	-
<b>DIMENSIONS</b>			
Dimensions (W x D x H) without handle/feet	318 x 253 x 128 mm [12.5 x 10 x 5 in.]	462 x 320 x 135 mm [18.2 x 12.6 x 5.3 in.]	456 x 273 x 324.5 mm [18 x 10.8 x 12.8 in.]
Weight without modules and batteries <sup>1)</sup>	Typ. 5.9 kg (13 lb.)	Typ. 8.5 kg (18.7 lb.)	Typ. 15 kg (33 lb.)

<sup>1)</sup> Weight of one battery: 540 g (1.20 lb.)

## OPTIONS AND ACCESSORIES



External battery pack: 250 W UPS with 3 battery slots [DW3-UPS-DC]



Connection box to power eight current transducers [DW2-CLAMP-DC-POWER-8]



Industrial USB 3.0 cameras for video input [CAM-ALVIUM-x]

# MAINFRAME SYSTEMS

- > Compact and flexible configuration
- > Convenient for mobile applications
- > Powerful PC inside for fast online displays and analysis

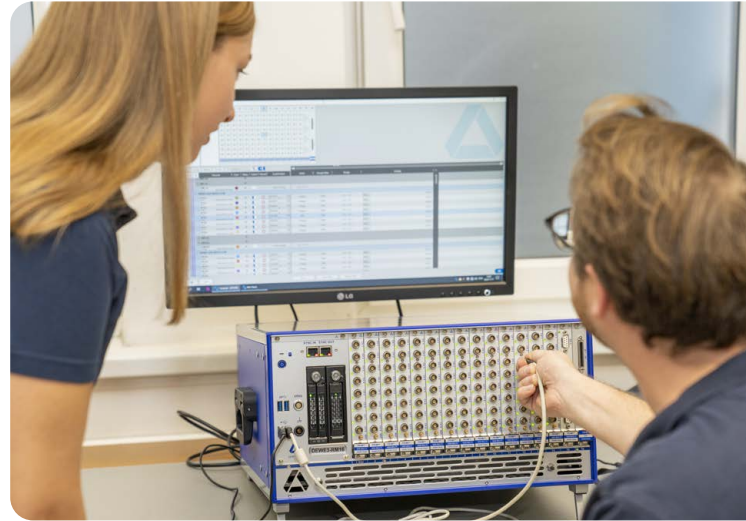

	DEWE3-M4	DEWE3-M8s
Slots for TRION / <b>TRION3</b> modules	4 TRION / <b>TRION3</b>	8 TRION / <b>TRION3</b>
High-speed channel expansion	Add TRIONet3 or OXYGEN-NET	
Low-speed channel expansion	XR modules	
Data storage	1 TB SSD dedicated for data storage 512 GB SSD for operating system and application software	
Optional data storage	Up to 4 TB	
Gapless storing rate	Typ. 400 MB/s	Typ. 800 MB/s
<b>POWER SUPPLY</b>		
Input voltage (max.)	10 to 36 V <sub>DC</sub> isolated; incl. external AC power supply	10 to 36 V <sub>DC</sub> isolated; incl. external AC power supply; optional battery powered; 2 separate power inputs for mutual power supply backup
Option 1	Internal buffer battery for ~5 min. operation (DW2-PS-DC-Butter)	n/a
Option 2	External battery pack, 3 battery slots (DW3-UPS-DC)	n/a
<b>DIMENSIONS</b>		
Dimensions (W x D x H) without handle/feet	318 x 253 x 108 mm (12.5 x 10 x 4.3 in.)	339 x 281 x 239 mm (5 u) (13.3 x 11.1 x 9.4 in.)
Weight without modules and batteries <sup>1)</sup>	Typ. 3.9 kg (8.6 lb.)	Typ. 9.1 kg (20.06 lb.)
<sup>1)</sup> Weight of one battery: 540 g (1.20 lb.)		

## OPTIONS AND ACCESSORIES



Box for connecting up to 4 GigE cameras; with integrated power supply  
[CAM-GIGE-SPLIT-01-BOX]



Optional 10 Gbit LAN interface available for  
DEWE3-A4, DEWE3-M4 and DEWE3-RMx



Box for powering up to 8 current transducers  
[DW2-CLAMP-DC-POWER-8]

# RACK-MOUNT MAINFRAMES

- > Rack-mount or benchtop data acquisition mainframe
- > Silent cooling, easy to maintain fan slot
- > Gapless storage of raw data up to 1 GB/s

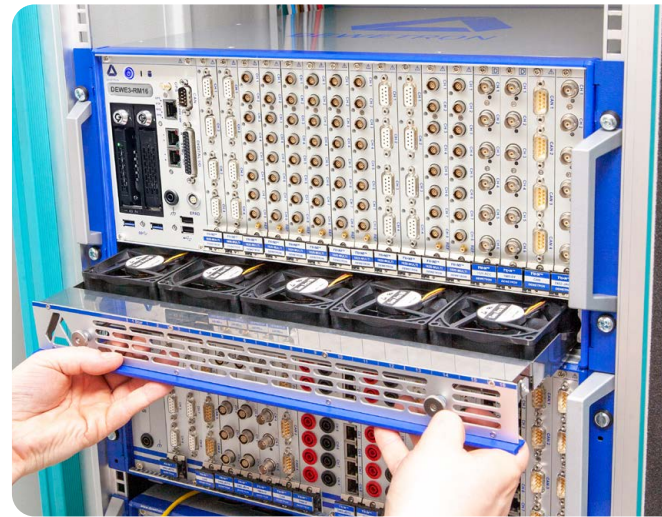

	DEWE3-RM4	DEWE3-RM8	DEWE3-RM12	DEWE3-RM16
Slots for TRION / <b>TRION3</b> modules	4 TRION / <b>TRION3</b>	8 TRION / <b>TRION3</b>	12 TRION / <b>TRION3</b>	16 TRION / <b>TRION3</b>
High-speed channel expansion	Add TRIONet3 or OXYGEN-NET			
Low-speed channel expansion	XR modules			
Data storage	1 TB high-speed PCIe Solid State Disk dedicated for data storage (removable) 512 GB SSD for operating system and application software			
Optional data storage	Upgrade from 1 TB to 2 TB industrial grade, PCIe attached Solid State Disk (SSD-PCIe-1T-2T)			
Gapless storing rate	Typ. 1 GB/s			
<b>POWER SUPPLY</b>				
Input voltage (max.)	90 to 264 V <sub>AC</sub>			
<b>DIMENSIONS</b>				
Dimensions (W x D x H) without handle/feet	442 x 435 x 222 mm (5 u) (17.4 x 17.1 x 8.7 in.)			
Weight without modules	Typ. 15.8 kg (34.8 lb.)			

## FRONT-END OPTION FOR MAINFRAME SYSTEMS

If your measurement system should not have a Windows operating system and no application software running on the system itself, we have the solution. We turn the mainframe chassis into a front-end system by installing our special Linux-based firmware. Applicable to DEWE3-M4/-M8s and all DEWE3-RMx mainframes. Converted to front-ends, these chassis then connect to a separate host PC via LAN interface. The standard interface is a 1 GBit Ethernet one. Optionally, a 10 GBit Ethernet interface is available for the DEWE3-RMx systems.



## AIRCRAFT VERSION FOR FLIGHT TESTING

**NEW**

The DEWE3-RM12-AIRCRAFT is a special variant of the DEWE3-RM12, engineered for onboard power supply system testing in modern aircrafts.

Different from the standard version, it features a 24 V<sub>DC</sub> power supply. Additionally, at the front are two vibration-resistant screw-lock RJ45 connectors for synchronization and Ethernet connection.



# TRIONet3 FRONT-END

- > Up to 100 m distance between the TRIONet3 systems
- > Gigabit LAN and USB3
- > Distributable and stackable

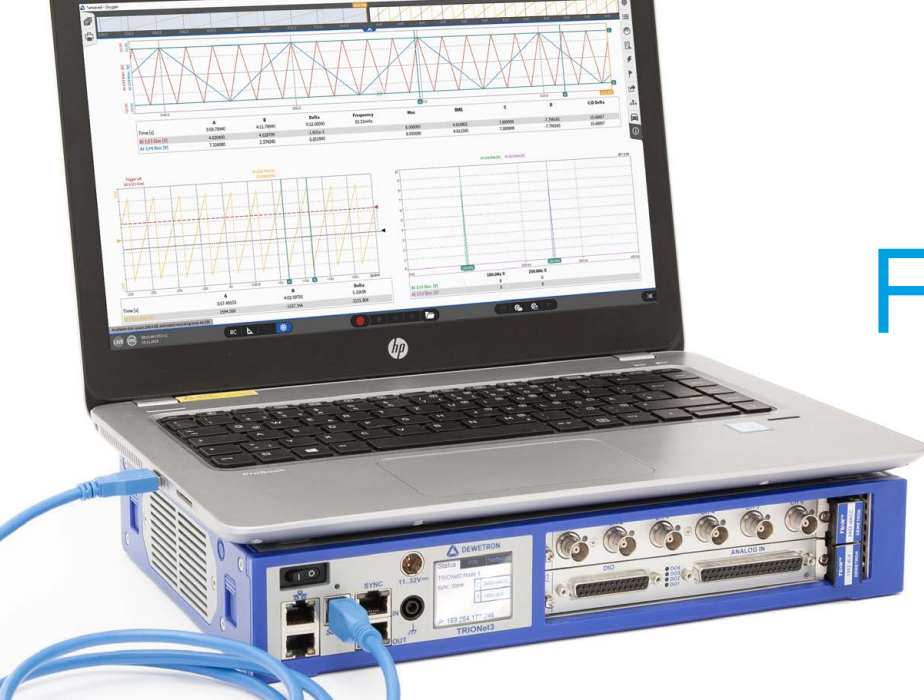

	TRIONet3
Slots for TRION / TRION3 modules <sup>1)</sup>	2 TRION / TRION3
Low-speed channel expansion	XR modules (requires CAN input)
LAN	2 x 1000BASE-TX Gigabit Ethernet
LAN configuration	DHCP or Static IP
USB	USB 3.0
Synchronization	TRION-SYNC-BUS up to 100 m between nodes
System bandwidth	90 MB/s with one connected TRIONet3 (up to 50 MB/s with more than one)
Display	Status display with touch-screen
Cooling	2 temperature controlled ultra silent fans
<b>HOST SYSTEM REQUIREMENTS</b>	
Supported operating systems	Linux or Windows; 64-bit
Supported interfaces	USB 3.0; 1000BASE-TX Gigabit Ethernet
<b>POWER SUPPLY</b>	
Isolated power supply (max.)	10 to 32 V <sub>DC</sub> (9 to 36 V <sub>DC</sub> )
Power consumption	Without modules 15 W, totally equipped max. 85 W
External power supply (included)	100 to 240 V ~50 to 60 Hz / 90 W
Option	Ext. battery pack, 3 battery slots for ~3 h operation (DW3-UPS-DC)
<b>DIMENSIONS</b>	
Dimensions (W x D x H)	320 x 205 x 55 mm (12.6 x 8 x 2.2 in.)
Weight without modules	Typ. 1.9 kg (4.2 lb.)
<b>ENVIRONMENTAL SPECIFICATIONS</b>	
Operating temperature	-20 °C to +60 °C (with pre-warmed unit)
Storage temperature	-20 to +70 °C
Humidity	10 to 90 % non cond., 5 to 95 % rel. humidity
Max. altitude	3000 m (9840 ft)
Sine vibration (EN 60068-2-6)	20 m/s <sup>2</sup>
Shock (EN 60028-2-27)	30 g
Random vibration (EN 60721-3-2)	Class 2M3

<sup>1)</sup> Unsupported module: TRION-ARINC, TRION-MIL1553, TRION-EtherCAT-1-Slave

## MOBILE WITH BATTERY PACK



TRIONet3 with DW3-UPS-DC battery pack for independent power supply

## DISTRIBUTED APPLICATION

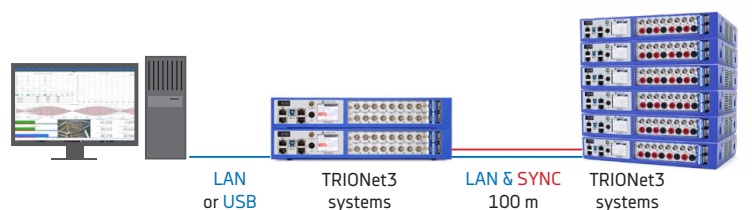

# RUGGED & COMPACT NEX[DAQ]

NEX[DAQ] is the flexible “everyday tool” for all test and validation engineers and troubleshooters. Small, lightweight & very rugged: the 8-channel NEX[DAQ] with universal inputs and a great price-performance ratio.



## INPUT SIGNALS

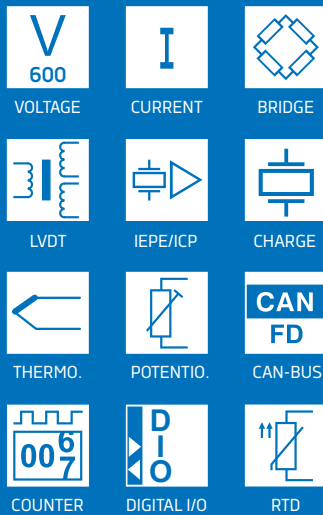

	NEX[DAQ]
Analog input	8 inputs for voltage up to $\pm 100$ V and full/half bridge, TEDS and MSI support
Further input types, via MSI	IEPE, quarter bridge, charge, RTD, LVDT, thermocouple, 0 to 20 mA, voltage up to $\pm 600$ V <sub>RMS</sub>
Sampling rate	24-bit, 200 kS/s or 1 MS/s per channel
Accuracy	$\pm 0.05$ % of reading, $\pm 0.02$ % of range $\pm 50$ $\mu$ V
Hardware filter	Butterworth and Bessel, 2 <sup>nd</sup> , 4 <sup>th</sup> , 6 <sup>th</sup> or 8 <sup>th</sup> order
Sensor excitation	1 V to 24 V, freely programmable
Counters, digital I/O	4 advanced counters and 8 basic counters/digital inputs, 4 digital outputs
CAN-bus	2 interfaces for CAN2.0 and CAN-FD
Interface to host PC	USB-C or Ethernet
Power	9 to 36 V <sub>DC</sub>
Power supply buffer	Buffered for 0.5 s in case of a voltage drop
Dimensions (W x D x H)	242 x 120 x 43.3 mm (9.52 x 4.72 x 1.7 in.)
Weight	1.25 kg (2.76 lb.)
Synchronization	Via Ethernet PTP/IEEE1588
Topology	Daisychain, Star

## POWER SUPPLY OPTIONS

The NEX[DAQ] offers multiple power options for easy and worry-free use in any situation.

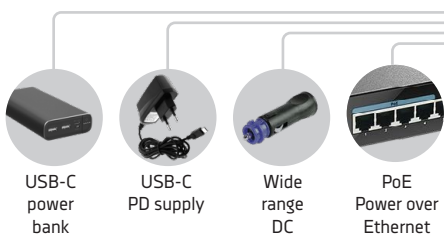

## HIGHER CHANNEL COUNTS



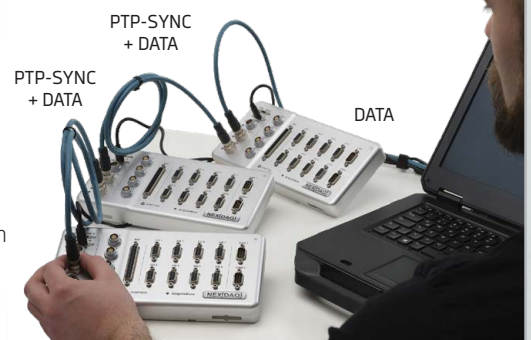









Simply daisy-chain multiple rugged NEX[DAQ]s into a multi-channel system. A single cable is sufficient for data transfer and synchronization via Ethernet PTP/IEEE1588.



# PURE RECORDING

## PU[REC]

The PU[REC] is a portable and reliable data acquisition system for field tests, troubleshooting and maintenance in various application areas.

- |   |   |
|---|---|
| <br>CURRENT             | <br>V<br>600<br>VOLTAGE    |
| <br>BRIDGE              | <br>LVDT                   |
| <br>VIBRATION           | <br>CHARGE                 |
| <br>THERMO-<br>COUPLE  | <br>POTENTIO-<br>METER    |
| <br>CAN-BUS           | <br>DIGITAL I/O          |
| <br>SENSOR<br>ADAPTER | <br>CHANNEL<br>EXPANSION |

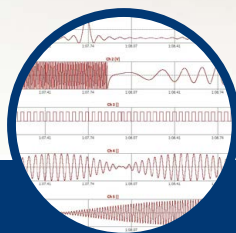

## SPECIFICATION

- > 16 measurement channels expandable via XR modules or MSI sensor interfaces
- > 50 kS/s or 200 kS/s sampling rate
- > Digital I/O and counter
- > CAN (optional)
- > Recording time of 168 h @ 50 kS/s or 42 h @ 200 kS/s
- > Full-HD 15.6" multi-touch display
- > Dimensions (W x D x H) 463 x 129 x 318 mm (18.2 x 5.1 x 12.5 in.)

## SOFTWARE

- > Analysis
- > Visualization
- > Post-processing
- > FFT analysis
- > Trigger & events
- > Math & calculation
- > Export features
- > Reporting
- > ...and many more

## RECORDING









- > Simple recording and storing of data
- > Quick navigation on your PU[REC] or any PC with our OXYGEN measurement software
- > Effortless data review also while still recording (DejaView)
- > Various trigger conditions and powerful trigger actions
- > Time-based & event-based file-split options
- > Channel-specific storing options for waveform and statistics data recording
- > Easy report and export features

# RUGGED CHANNEL EXPANSIONS



Extend your measurement system with our low-speed channel expansions for temperature, voltage, current or resistance temperature measurements.

- > Ruggedized measurement modules with integrated A/D conversion
- > Extended operating temperature of -40 to +85 °C
- > Fully isolated: channel to channel and channel to bus, power and chassis
- > XR modules are extremely rugged and waterproof
- > RS-485 or CAN interface (freely selectable with programmable interface)
- > Sample rate: up to 200 Hz for CAN; up to 10 Hz for RS-485

XR MODULE		CHANNELS	INPUT RANGES	ISOLATION	SAMPLE RATE PER CHANNEL	IP RATING	
XR-RTD8			8 isolated resistance temperature detector (RTD) inputs	Resistance: 0 to 5000 Ω RTD: Pt100, Pt200, Pt500, Pt1000, Pt2000	350 V <sub>DC</sub>	CAN: 200 S/s RS-485: 10 S/s	IP 68 immersion depth 3 m
XR-TH8-S			8 isolated thermocouple inputs	Types K, J, T, R, S, N, E, L, C, U, B	1500 V <sub>AC</sub>	CAN: 200 S/s RS-485: 10 S/s	n/a
XR-LA8			8 isolated current inputs	0 to 20 mA; ±20 mA; ±30 mA	350 V <sub>DC</sub>	CAN: 200 S/s RS-485: 10 S/s	tbd.
XR-V8			8 isolated voltage inputs	Physical in. range: ±50 V Software selectable: ±100 mV, ±500 mV, ±1 V, ±2.5 V, ±5 V, ±10 V	350 V <sub>DC</sub>	CAN: 200 S/s RS-485: 10 S/s	IP 68 immersion depth 3 m

## STATIC EXPANSION



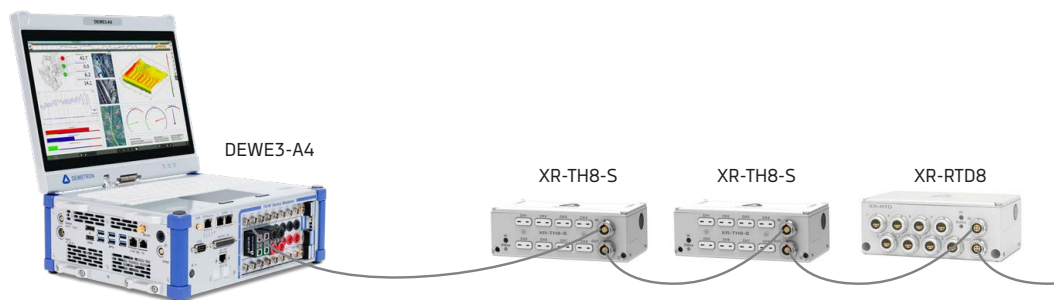





Add one or more ruggedized XR modules for more low-speed inputs. Interface is freely programmable as RS-485 or CAN interface.



# MSI SENSOR ADAPTER

MSI (Modular Smart Interfaces) expand the functionality of TRION(3) and PU[REC] inputs.

- > Automatically detected and set up
- > Supported on TRION(3)-x-MULTI, TRION(3)-1802 and TRION(3)-1600 with TRION-X-dLV-CB16-D9 connector box

MODULAR SMART INTERFACES (MSI)	INPUT	SENSOR EXCITATION	BANDWIDTH (MAX.)	ACCURACY (TYP.)	SENSOR CONNECTION
 MSI2-250R-20mA	4 to 20 mA sensors	5 to 48 V AUX PWR	DC to 250 kHz <sup>1)</sup>	±0.1 %	Miniature spring terminals
 MSI2-STG	Bridge type sensors Full-bridge, half-bridge, quarter bridge 120 Ω and 350 Ω	5 V and 10 V	60 kHz <sup>1)</sup>	±0.1 %	Miniature spring terminals
 MSI2-LVDT	LVDT and RVDT sensors, 5- or 6-wire connection	3 V at 2.5, 5 or 18 kHz	1 kHz <sup>1)</sup>	±0.1 %	Soldering pads
 MSI-BR-ACC	IEPE® sensors, typ. accelerometer, microphone	4 mA	1.4 Hz to 250 kHz <sup>1)</sup>	±0.2 %	BNC
 MSI2-CH-x	Charge type sensors up to 100 000 pC	n/a	0.08 Hz to 250 kHz <sup>1)</sup>	±0.5 %	BNC
 MSI2-TH-x	Thermocouple sensors; standard models for type K, J, T (others on request)	n/a	DC to 30 kHz <sup>1)</sup>	±1 °C	Mini TC socket
 MSI-BR-V-200	Voltage up to ±200 V	n/a	DC to 100 kHz <sup>1)</sup>	±0.1 %	BNC
 MSI2-V-600	Voltage up to 600 V <sub>RMS</sub>	n/a	DC to 60 kHz <sup>1)</sup>	DC to 1 kHz: ±0.1 % of reading ±100 mV >1 kHz to 5 kHz: ±0.5 % of reading ±100 mV >5 kHz to 10 kHz: ±1 % of reading ±100 mV	Safety banana
 MSI-BR-RTD	RTD sensors Pt100, Pt200, Pt500, Pt1000, Pt2000; 2, 3 & 4 wire connection	1.25 mA	DC to 10 kHz <sup>1)</sup>	±0.1 %	Binder 712 series 5-pin socket

<sup>1)</sup> Consider limit of used TRION(3) module

## MSI CONNECTOR BOX

The MSI connector box TRION-X-dLV-CB16-D9 is a feature expansion box for TRION(3)-1802-dLV-32 and TRION(3)-1600-dLV-32 modules by MSI (Modular Smart Interfaces) support. This connector box enables measurement of strain gauge and bridge sensors, IEPE®, LVDT and RVDT, thermocouple, charge, RTD and voltage up to 600 V<sub>RMS</sub>.



Connection to TRION(3)-x-dLV

# NO LIMITATIONS WITH SYNCHRONIZED SYSTEMS

If you need more than one DAQ system, even on different locations, we have several networking solutions for you.

## OXYGEN-NET

The OXYGEN-NET software option makes it possible to combine multiple devices to one virtual measurement device.

- > Easy-to-use synchronized measurement for hundreds of input channels from 10 S/s to 10 MS/s per channel
- > Works with absolute time synchronization (PTP, IRIG, GPS) as well as with the built-in TRION-SYNC-BUS
- > Remote and local data storage possible for redundancy
- > Setup and control of all nodes from the main device

SYNC for  
100s  
of channels

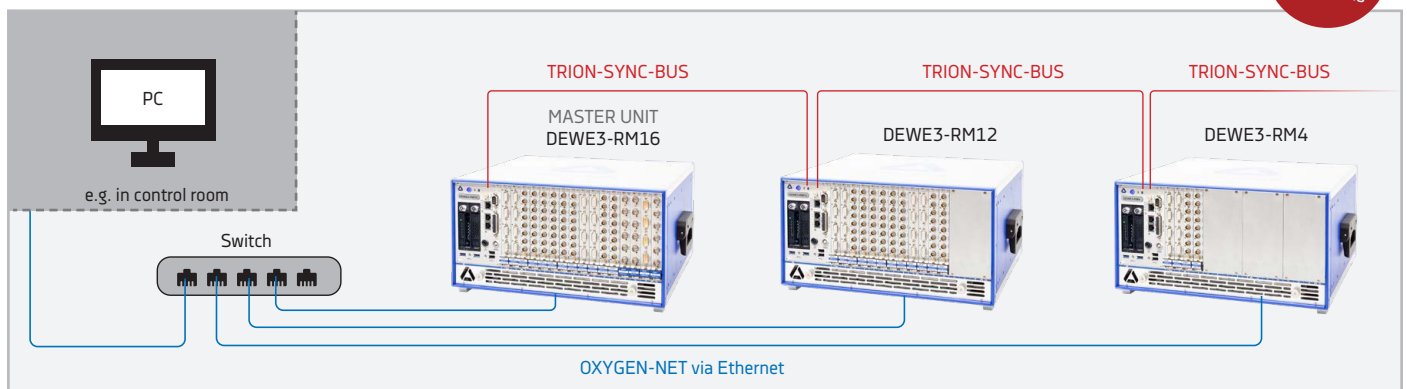

## EXPANSION FOR MORE CHANNELS

You need more channels for your DEWETRON system?

No problem! Expand your system via front-ends or XR modules, depending on the necessary speed.

### FRONT-END EXPANSION

Add one or more TRIONet3 front-end chassis for more channels and high-speed expansion. Up to 100 m between units possible.

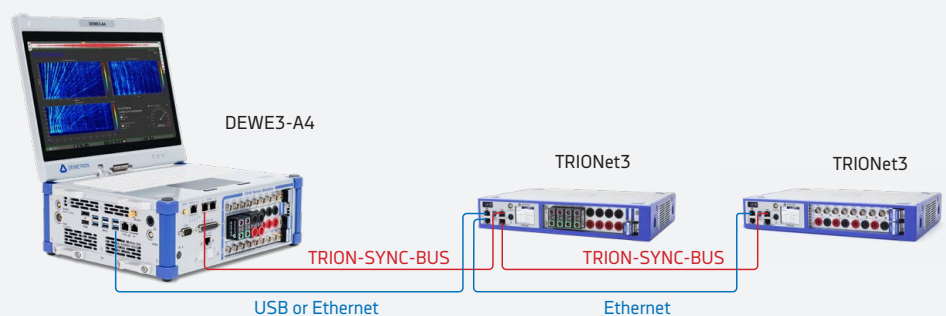

### STATIC EXPANSION

Add one or more rugged and waterproof XR modules via CAN or RS-485 interface

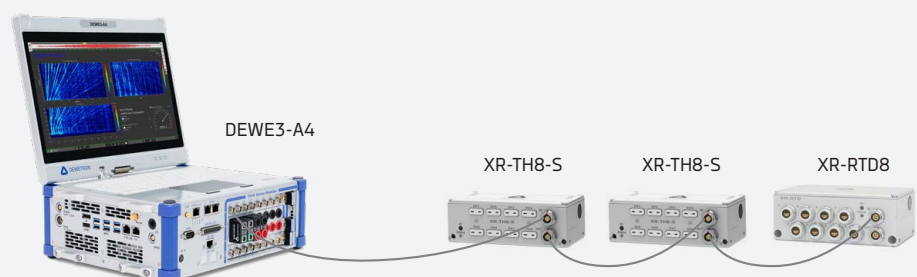

# SYNCHRONIZATION POSSIBILITIES

Synchronization of multiple systems ensures perfectly synchronized measurements without any time shifts between the systems and therefore guarantees highest data quality. DEWETRON offers various synchronization possibilities to have the ideal solution for every application. Different sync sources can be used such as GPS, PTP, gPTP, IRIG or PPS.

NEW

## PTP-SYNC / gPTP-SYNC

Various instruments from DEWETRON or 3<sup>rd</sup> party instruments can be synchronized via PTP (Precision Time Protocol) and gPTP (Generalized Precision Time Protocol). Data transmission via Ethernet and local data storage possible.

- OPTIONAL:
- PTP sync signal can be generated by DEWETRON systems or by PTP sync generator

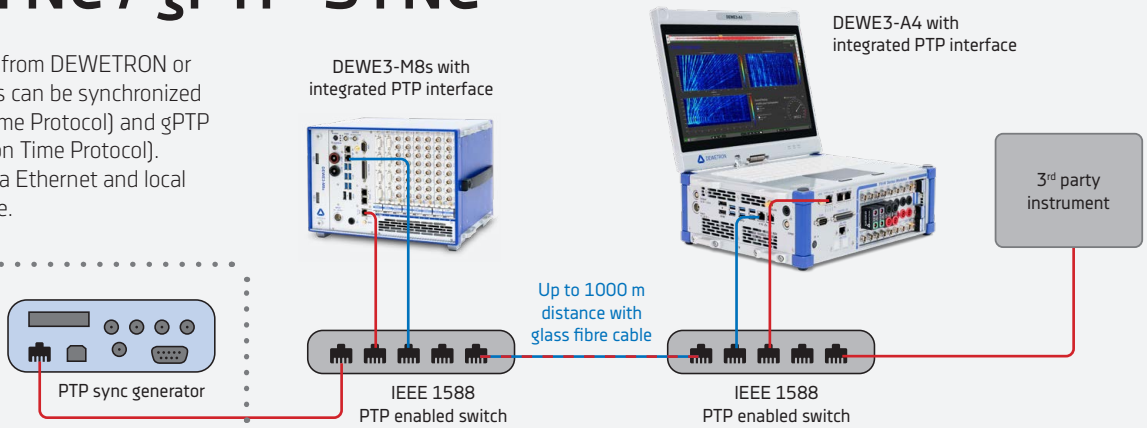

## GPS-SYNC

Two or more instruments synchronized via GPS.

Most systems are equipped with GPS-interface directly on the front panel. For others, you need the TRION-VGPS-V3 module.

Data transmission via Ethernet and local data storage possible.

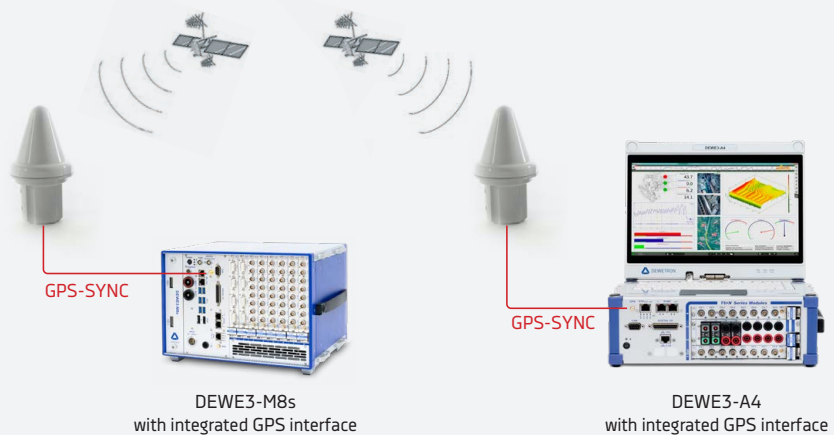

## IRIG-SYNC

Use your DEWETRON chassis as an IRIG (InterRange Instrumentation Group) master to output an IRIG B DC signal for synchronization via three possibilities:

- > Directly at the front panel (depending on the chassis)
- > TRION-TIMING-V3
- > TRION-VGPS-V3

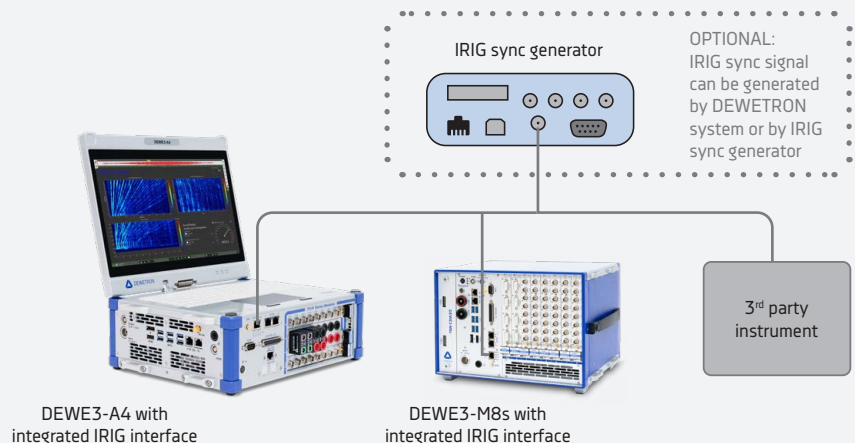



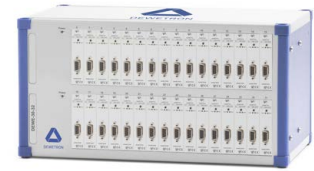

# ANALOG SIGNAL CONDITIONING

Chassis for isolated signal conditioning amplifiers, suitable for a wide variety of sensors.



	DEWE-30-16	DEWE-30-32
Slots for DAQP modules	16	32
Interfaces	RS-232, RS-485, XR	
Conditioned signal output	±5 V (±10 V as option), buffered	
Output connector standard	D-SUB-37	
Output optional	BNC	
Power supply	100 to 240 V <sub>AC</sub>	
Optional power supply	10 to 32 V <sub>DC</sub>	
Dimensions	438.5 x 253 x 133 (17.3 x 10 x 5.2 in.)	438.5 x 253 x 253 mm (17.3 x 10 x 9.6 in.)
Weight (depending on configuration)	4.5 kg (9.9 lb.)	7 kg (15.4 lb.)
<b>ENVIRONMENTAL SPECIFICATIONS</b>		
Operating temperature	0 to +60 °C	
Storage temperature	-20 to +70 °C	
Humidity	10 to 90 % non cond., 5 to 95 % rel. humidity	
Vibration	EN 60068-2-6, EN 60721-3-2 class 2M2	
Shock	EN 60068-2-27	

## UNIVERSAL ANALOG MEASUREMENT

UNIVERSAL ANALOG MODULE	FEATURES	BANDWIDTH	ISOLATION	CONNECTOR TYPE
 <b>DAQP-STG</b>    	Auto sensor balance Internal completion for 1/2 and 1/4 bridge µV amplifier with high bandwidth Continuously variable gain from 0.5 to 10 000	300 kHz	350 V <sub>DC</sub>	D-SUB

## COMBINATION WITH TRION(3)/DEWE3-SYSTEMS

Use the TRION(3)-1802-dLV or TRION(3)-1600-dLV as input modules for the conditioned analog signals.



DEWE-30-16

Conditioned analog signals ±5 V



DEWE3-M4 with TRION-1802-dLV module



# OXYGEN MEASUREMENT SOFTWARE

With the OXYGEN all-in-one software, the data acquisition, recording, calculation, visualization and analysis has never been easier. Use only one software for all applications. Also for 3<sup>rd</sup> party components.



Windows

Linux



We are the only manufacturer of measurement technology to offer you the advantage of choosing between Windows and Linux.

DEWE3-A4L

DEWETRON

NEW

## MOBILE APP

Starting with OXYGEN 8.0 the mobile app for remote configuration is available.

Download the free app now.

ON THE GO WITH  
OXYGEN-GO



Download on the App Store

GET IT ON Google Play

DOWNLOAD  
OUR NEW APP

# DATA ACQUISITION

Synchronous and continuous acquisition of data from several sources: analog, digital, encoder, counter, CAN, SCPI, Ethernet, video, GPS and many more.

- > Analog data with up to 10 MS/s
- > Digital and encoder data with automatic RPM and angle calculation
- > CAN(-FD) decoding via \*.dbc including J1939. Compatible with Vector VN-series
- > Ethernet receiver for external sensors (opt.)
- > Video data from USB or GigE-camera
- > Precision GPS position data via TRION3, GeneSys ADMA or OxTS RT series
- > Plugin to request and decode OBD2 parameters



# RECORDING

Store all your acquired data in one data file with a simple touch on the record button. You can achieve data rates of up to 1 GB/s and you never have to worry about losing any data. Furthermore, review your data during recording with the DejaView function.

- > File-split option for generating a new file after an amount of time or event occurrence
- > Channel-wise sample rate selection
- > Channel-specific storing options for waveform and statistics data recording
- > Adjustable playback speed from 1/1000x to 1000x

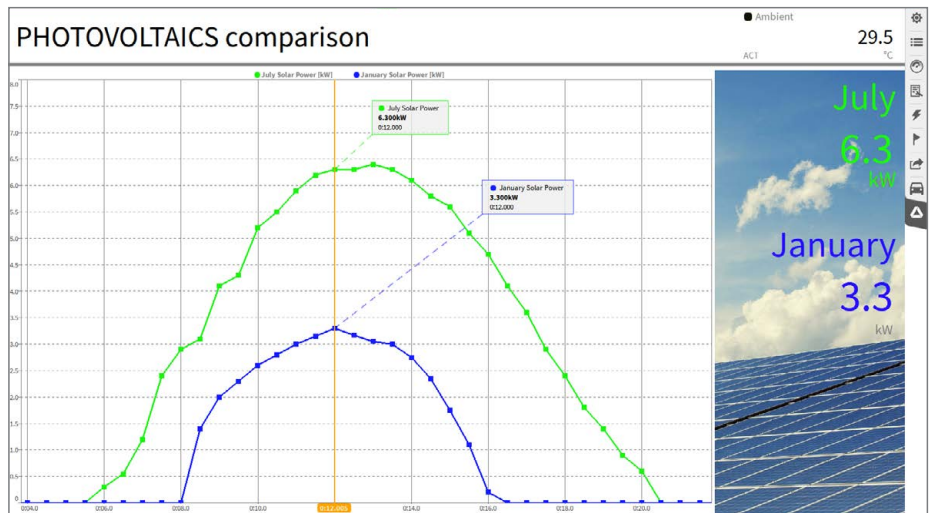

# ANALYSIS AND POST-PROCESSING

The real work often begins after the live measurement. To complete this workflow, OXYGEN also supports post-processing and analysis of the recorded data.

- > Use many of the math and calculation (also incl. FFT) features to refine your measurement results
- > Create new visualizations and measurement screens
- > Quickly navigate through the data with well-known gestures and intuitive zoom and scrolling mechanisms
- > Export data to complete your workflow

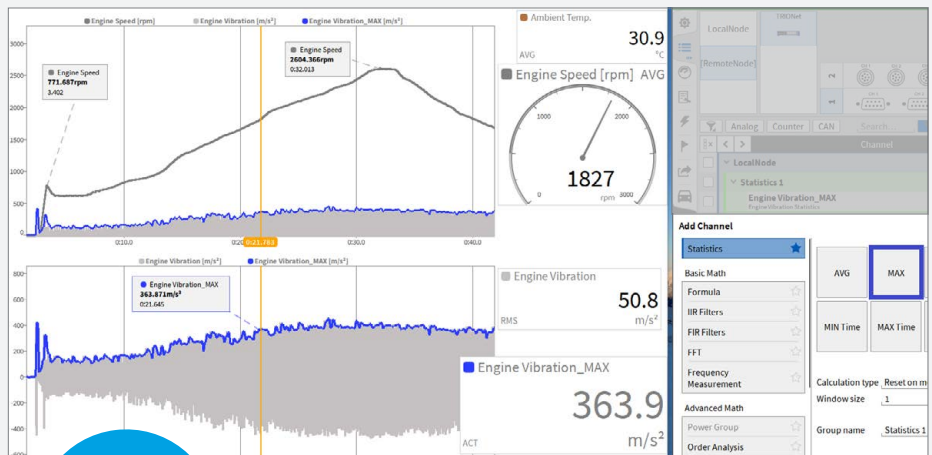

For post-processing, you do NOT need an OXYGEN license

# REPORTING

Use OXYGEN for your whole measurement workflow. From acquiring data to post-processing and finally reporting the data.

- > Create separate reporting pages (additional to the measurement screens) with typical printing layouts
- > Duplicate a measurement screen or create new pages with a simple click
- > Use all instruments and visualizations also in the reporting pages
- > Separate time-cursor on each page available to report different time snippets in one report
- > Directly print or save to pdf
- > Export your measurement to a video

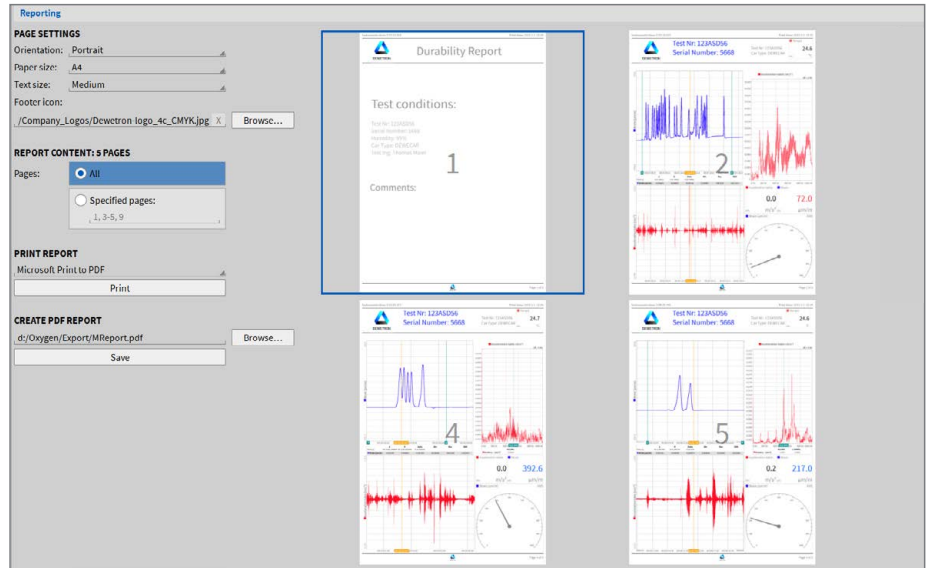

# EXPORT

If you need to use other analysis software for further data processing, we offer data export for the most common applications and formats.

- > Universal formats: CSV and TXT with selectable delimiter and timestamp format
- > Advanced formats: Excel, MATLAB, ASAM MDF4, DIAdem, DSPCon, DynaWorks, IMC Famos 2, HDF5, MTS RPC III, NetCFD, NI TDMS, Universal File Format 58, Wave
- > Select channels and/or time-range of the exported data
- > Optional automatic export at measurement end

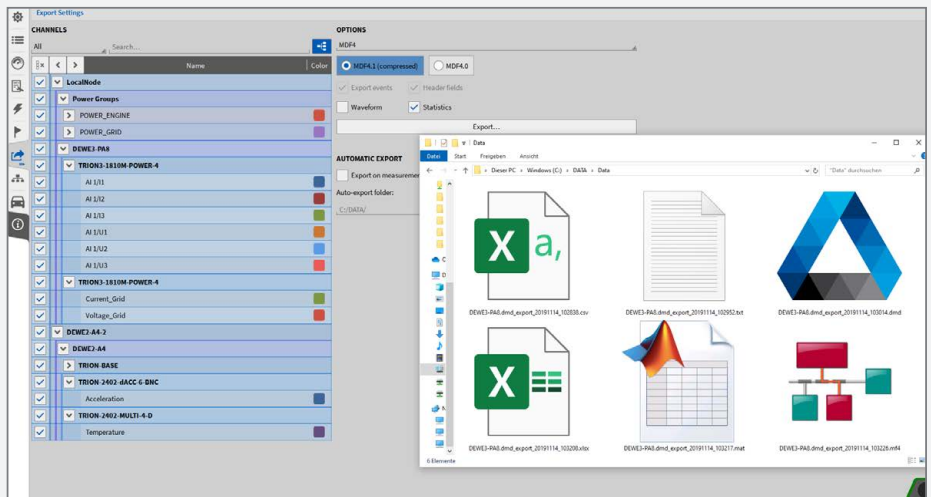

# MATH AND CALCULATION

- > FORMULA: For arithmetic and more advanced calculations (trigonometric, logical and measurement functions)
- > STATISTIC: Block-wise, Triggered and Overall- statistics to calculate statistic values, e.g. AVG, RMS, MIN and MAX, PP...
- > FILTER High, low, bandpass and bandstop IIR-filter and FIR-filter up to the 10<sup>th</sup> order
- > DMS-ROSETTE calculation module for 45°, 60°, and 90° setups
- > PSOPHOMETRIC ANALYSIS for railway and telecommunication applications
- > FFT spectra overlap, peak hold and pin extraction
- > INTEGRATION / DERIVATION with optional signal filter

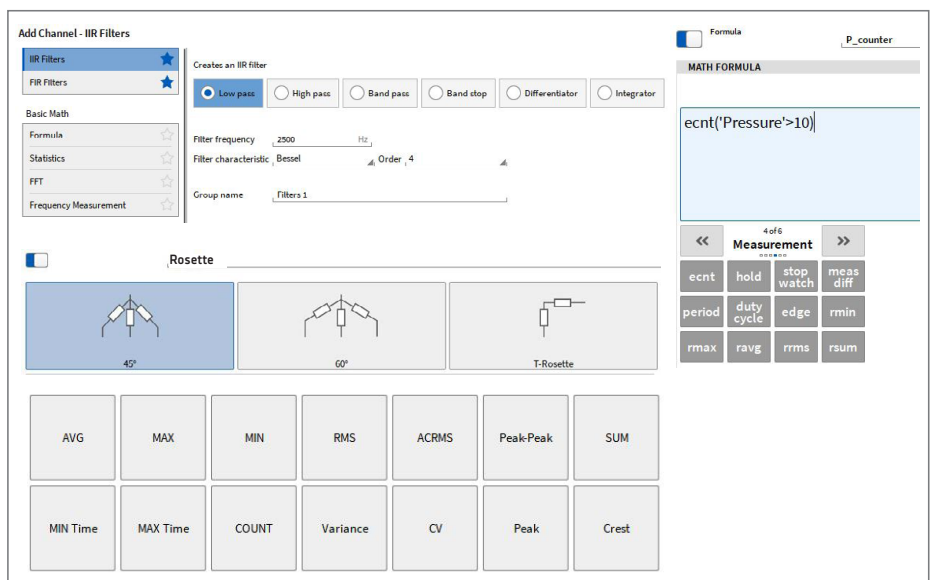

# TRIGGER & EVENTS

The powerful trigger and event system makes it easy for you to record data in case of events, create marker, set a digital output or make a snapshot of the actual measured data. Create different events, each consisting of one or more trigger conditions and one or more actions.

- > Many different trigger conditions: signal level (positive/negative edge, window) with optional rearm level, keyboard or time
- > Powerful actions like start/stop of recording, set an alarm with optional digital output, set a marker with pre-defined text or make a snapshot of the actual measured data.

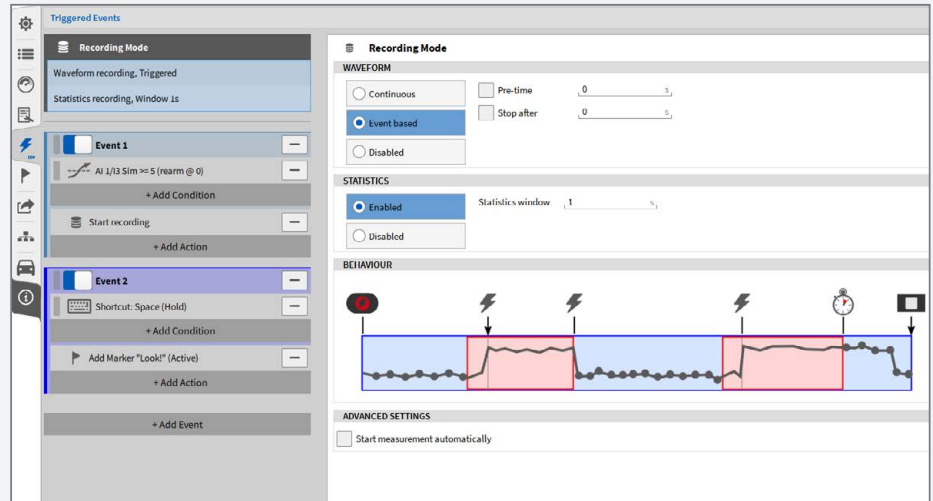

# VIDEO INPUT

Cameras are implemented as additional sensors in OXYGEN, so you really get the “complete picture” of your measurement task.

Applications start with very simple video documentation (measurement setup, weather, environment, etc.) with a cheap webcam and extend to really complex tasks with up to 8 cameras, whose individual frames are perfectly synchronized with all other data (e.g. analog, CAN, counters, GPS...).

- > USB webcams
- > Synchronized USB and GigE cams, up to 289 fps
- > High-speed cams, up to 100.000 fps (post sync)



# OXYGEN-NET

Many applications require more than one measurement device, sometimes even at different locations.

OXYGEN-NET makes it possible, to sum up all devices to one virtual measurement device. You only need a reliable network connection, and you can simply claim all available nodes and operate it from the main device.

- > Create one big virtual device with several remote nodes (measurement cloud)
- > No complicated settings needed, simply claim and remove nodes with one click
- > Works with absolute time synchronization as well as with TRION-SYNC-BUS
- > Remote and local data storage possible for redundancy
- > Multiple Master clients and redundant Master clients supported

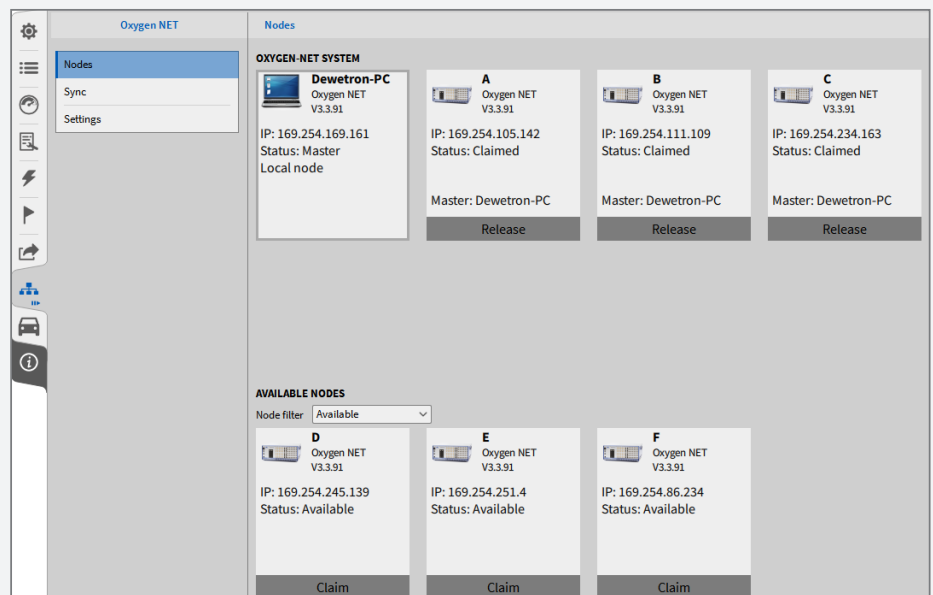

# SOUND LEVEL

The sound level plugin provides online determination of the time-dependent sound pressure level, the energy equivalent sound pressure level, freely definable statistical sound pressure levels and many more. This plugin turns your DEWETRON device into the ideal solution for analyzing the acoustical emission of machines, for determining the spatial and statistical sound pressure level distribution in buildings and for long-term noise monitoring.

- > A-, B-, C-, D- and Z-frequency weighting (according to DIN EN 61672-1)
- > Fast, slow and impulse time weighting (according to IEC 651)
- > Reference level for air (20  $\mu$ Pa) and water (1  $\mu$ Pa)
- > Overall and interval logging
- > Audio replay feature

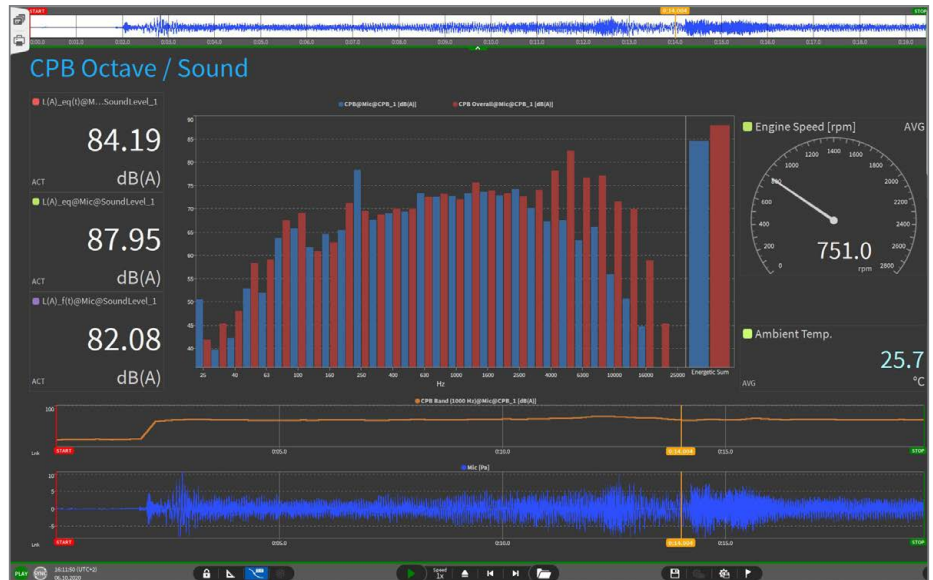

# FFT ANALYSIS

Experience top-tier frequency domain analysis with OXYGEN's flexible and user-friendly FFT Analysis. Benefit from powerful instruments and math calculations to tackle any task:

- > Freely selectable (not only 2N) number of input samples or line resolution.
- > Optional zero-padding for enhanced line resolution.
- > Various windowing and scaling types selectable.
- > Reference curves to visualize thresholds and warnings in the frequency domain.
- > STFT to visualize spectral changes in time.
- > Various 2- and 3-dimensional visualization and analysis options.

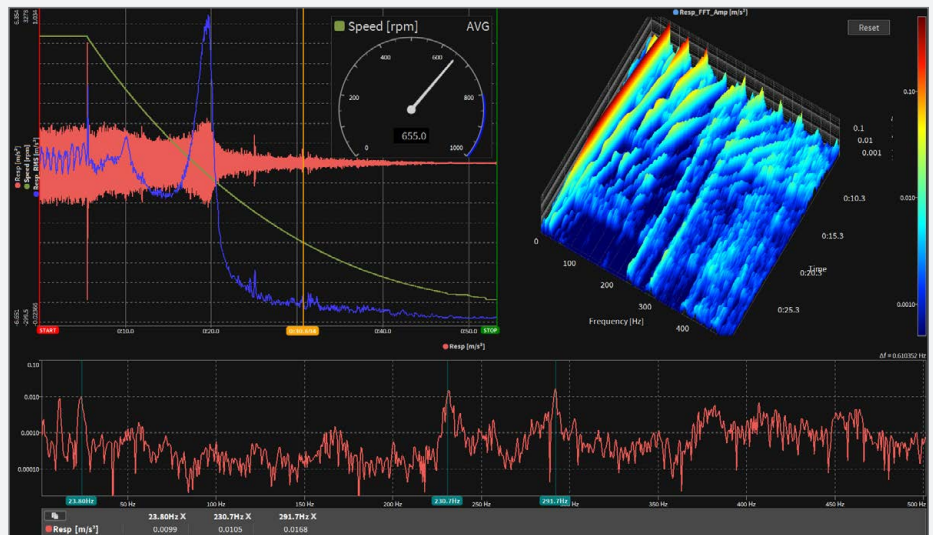

# MODAL TEST

With OXYGEN's Modal Test option you can analyze the frequency characteristics of a mechanical structure to determine resonances, damping characteristics and more.

- > DUT excitement via modal hammer
- > SISO & SIMO tests with moving hammer and moving sensor
- > Calculation of
  - > Complex transfer function
  - > Coherence of several hits
  - > Mode indicator function
- > Various interactive visualization options
- > Data export into \*.uff and other formats for post processing
- > Modal shape animation
- > SDOF circle fit

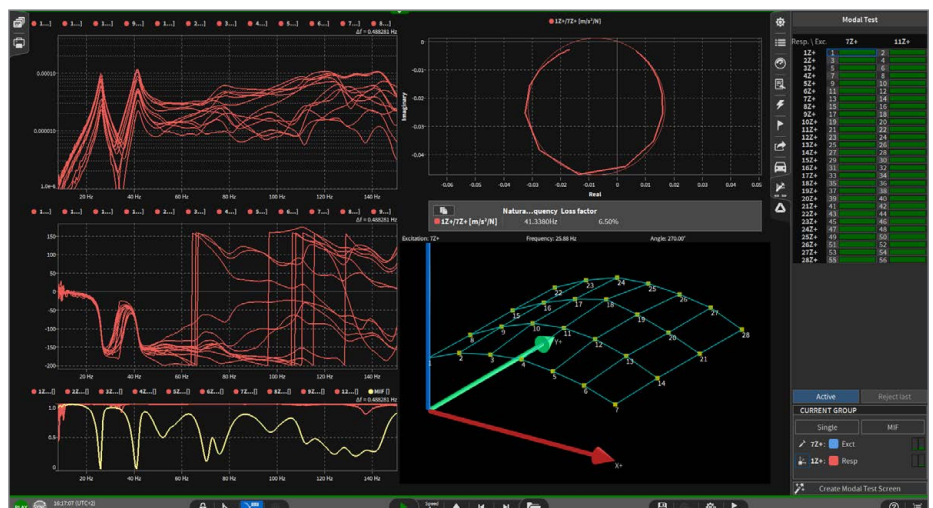

# ORDER ANALYSIS

The noise and vibration analysis module for rotating machines turns your OXYGEN into a full order analysis instrument for calculation and visualization of frequency and order spectra vs. speed.

- > Simultaneous frequency and order domain analysis
- > Smart resampling algorithm for accurate and fast results
- > Selectable speed ranges from 60 RPM to 100 000 RPM
- > Order resolution from 0.01 to 1, with up to 90 % overlapping
- > Order extraction for selected orders for use in recorder or XY-instrument
- > Visualization of the resulting matrix in intensity diagrams
- > Visualization of extracted orders in Orbit Plot and Polar Plot

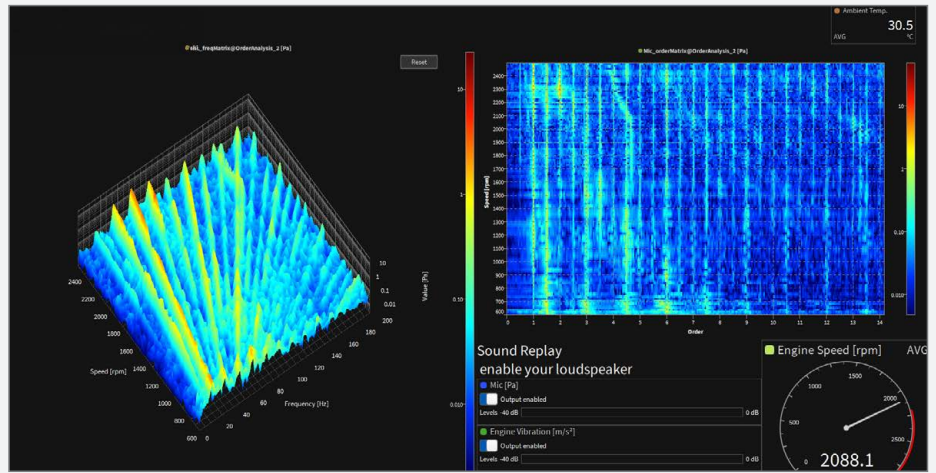

# EFFICIENCY MAPS

The matrix sampler is the solution for visualizing the efficiency of your electric drivetrain at different load steps or running speeds online. Create the calculation module directly in your power group. The efficiency map of the drivetrain will be filled up during the measurement.

- > Possibility to refill single measurement points without overwriting the whole matrix
- > Easy-to-use and intuitive operation
- > Several trigger options to fill the map with data
- > Freely definable matrix size
- > Assignment of any channel to X-, Y- and Z-axes for visualizing any 3-dimensional signal dependencies

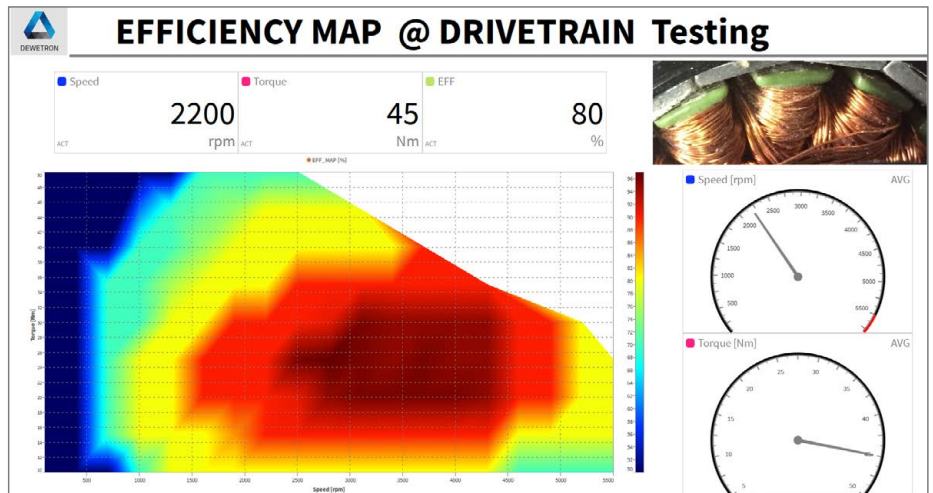

# POWER ANALYSIS

Turn your DEWETRON measurement device into a fully-featured power analyzer:

- > Analysis of 1-9 phase power systems (1P2W, 2V2A, 3P3W, 3P4W, 2x 3P3W, ...)
- > Several power systems are logically summarized into power groups
- > Gapless cycle-by-cycle calc. no blind spots
- > Unique fundamental frequency detection with delay compensation for highest accuracy and reliability
- > BASIC: vol., curr., RMS, AVG, fundamental & symmetrical components, active/reactive/apparent power total & fundamental, energy
- > ADVANCED: harmonics (IEC 61000-4-7), flicker (IEC 61000-4-15), flicker emission (IEC 61400-21) and mechanical power/efficiency
- > EXPERT: rolling calculation meets FGW-TG3



# SDK FOR PROGRAMMERS

With DEWETRON, you get an open platform to develop your own measurement application or extension. Depending on your requirements, you can choose between two Software Development Kits: OXYGEN-SDK and TRION-SDK.

## OXYGEN SDK

With OXYGEN SDK, you are capable to develop your own plugins for the OXYGEN measurement software.

### AVAILABLE FEATURES FOR THE PLUGIN

- > Advanced calculations and data processing
- > 3<sup>rd</sup> party data output
- > Data output
- > Special export formats
- > Read and write data from/to numeric channels
- > Create new channels
- > Create config items for setup save/load and user config
  - > Numeric, text, channel list
- > Integration of video sources

This and much more allows you, to extend OXYGEN with additional calculations and data I/O.

### AVAILABLE FUNCTIONALITY

- > Custom QML-GUI for add channel dialog for easy user setup
- > Custom QML-GUI for data export and special options
- > User configuration elements
  - > Text and number inputs for all kinds of configuration
  - > Combo boxes (drop-down & custom input)
  - > File picker for selecting files
- > Read data from any OXYGEN channel
- > Create new OXYGEN channels and write data into

### EXAMPLE PLUGIN FUNCTIONALITIES

- > Easy setup of the MS Visual Studio environment with SDK wizard
- > XR plugin
- > OBD2 plugin
- > Frequency measurement
- NEW** > Camera integration

### SPECIAL DATA SINKS

- > Ethernet sender

### SPECIAL EXPORTER

- > Dynaworks
- > DIAdem

### SPECIAL DATA SOURCES

- > SCPI query plugin
- > AK dyno plugin
- > Serial CSV reader
- > Modbus TCP/IP

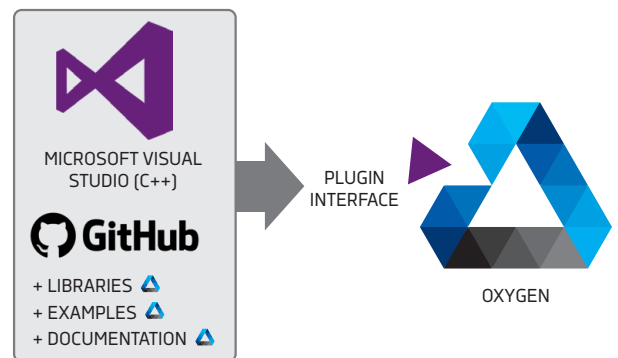

If OXYGEN does not provide a certain function, create it on your own

Get started and visit <https://github.com/DEWETRON/OXYGEN-SDK>



## TRION SDK

The TRION SDK helps you, to build your own measurement application based on the DEWE3 and TRION/TRION3 hardware platforms. It also supports the use of TRIONet.

We support Windows 10 (64-bit), Ubuntu, and Redhat/CentOS Enterprise Linux.

C/C++ are the natively supported programming languages, additional bindings to Python, C# and Delphi.

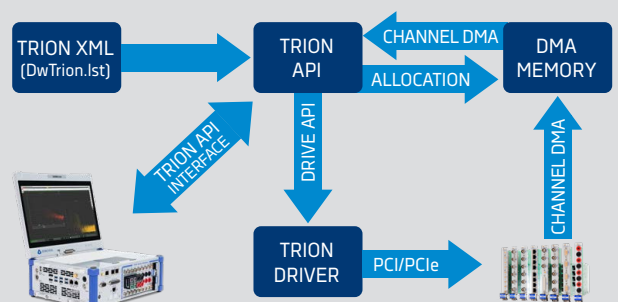

# 1

## OXYGEN SCPI VI

Use the OXYGEN SCPI interface to transfer data into LabVIEW™ during data acquisition and recording in OXYGEN. Various channels like analog, math or power group channels are supported. The channel setup and configuration is done in OXYGEN and the data can be stored redundantly in OXYGEN and LabVIEW™.

### SCOPE OF SUPPLY

- > OXYGEN's SCPI interface for data transfer and configuration
- > LabVIEW™ VI including the required SCPI commands
- > Documentation included in LabVIEW™ code
- > Quick start programming example
- > Maximum data transfer rate: 10 kS/s
- > Typical number of channels to be transferred: 100 channels

### WHEN TO USE

- > Channels calculated in OXYGEN (such as power groups) shall be transferred into LabVIEW™
- > Integration of DEWETRON data acquisition system into a LabVIEW™ based test bed
- > No LabVIEW™ based hardware configuration required

*NOTE:*  
Requires LabVIEW™ on the data acquisition system or on a separate PC that is connected to the same Ethernet network as the data acquisition system.

NI LabVIEW  
INTEGRATION

FOUR SOLUTIONS TO SOLVE YOUR MEASUREMENT

# 2

## LABVIEW™ DRIVER FOR TRION(3)

Use the hardware driver to gather data from the TRION API, which is in direct communication with LabVIEW™. TRION and TRION3 modules in any chassis are supported. The hardware and channel configuration is done in LabVIEW™.

### SCOPE OF SUPPLY

- > User friendly encapsulation of the device functions into VIs
- > Possibility to acquire the measurement data from the TRION boards in LabVIEW™ with just a few VIs
- > Dedicated VIs for channel configuration
- > Documentation included in LabVIEW™ code
- > Quick start programming examples included

### WHEN TO USE

- > For customized software solutions developed in LabVIEW™
- > When TRION hardware shall be used in parallel with 3rd party hardware in LabVIEW™
- > For solutions requiring regulation and automation based on LabVIEW™

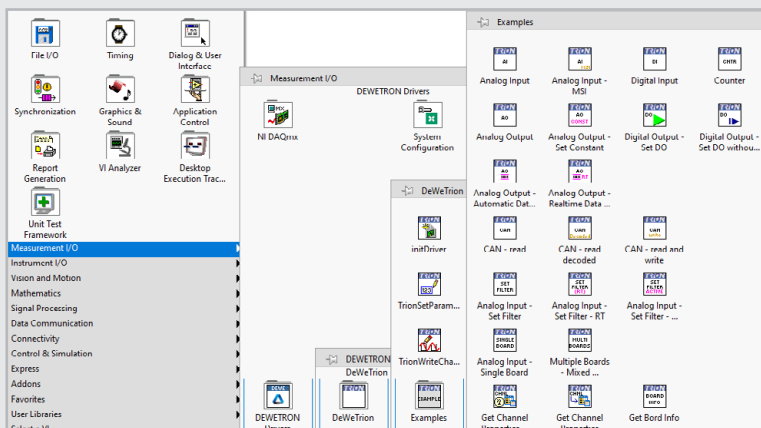

*NOTE:*  
Requires LabVIEW™ installed on the data acquisition system (or on the host PC in case TRIONet3 is used)

# OXYGEN DATASTREAM VI

Use the OXYGEN DataStream interface to transfer data into LabVIEW™ during data acquisition and recording in OXYGEN. Various channels like analog, math or power group channels are supported. The channel setup and configuration is done in OXYGEN and the data can be stored redundantly in OXYGEN and LabVIEW™.

## SCOPE OF SUPPLY

- > OXYGEN's SCPI interface for data transfer and configuration
- > LabVIEW™ VI including the required SCPI commands
- > Documentation included in LabVIEW™ code
- > Quick start programming example
- > Maximum data transfer rate: native channel sample rate
- > Typical number of channels to be transferred: 100 channels à 100 kS/s

## WHEN TO USE

- > Channels calculated in OXYGEN (such as power groups) shall be transferred into LabVIEW™
- > Integration of DEWETRON data acquisition system into a LabVIEW™ based test bed
- > No LabVIEW™ based hardware configuration required

*NOTE:*  
Requires LabVIEW™ on the data acquisition system or on a separate PC that is connected to the same ethernet network as the data acquisition system



SEAMLESSLY INTEGRATE  
T DATA INTO LabVIEW™

# OXYGEN \*.TDMS-EXPORT

Export your OXYGEN \*.dmd data files directly into the \*.tdms format to open the files in LabVIEW™. Different export options are available (export all or only specific channels, entire data or only specific time span, ...).

## SCOPE OF SUPPLY

- > Standard OXYGEN \*.tdms export

## WHEN TO USE

- > Direct export into the LabVIEW™ format
- > Easy integration of data into LabVIEW™
- > No configuration required

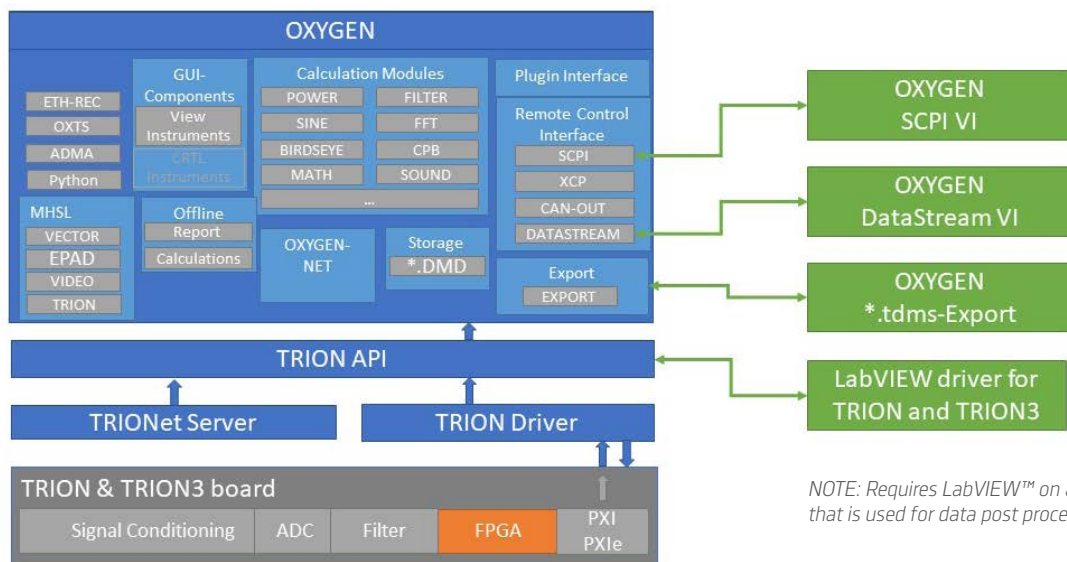

*NOTE:* Requires LabVIEW™ on an arbitrary PC that is used for data post processing.

# CUSTOMER CARE CENTER

Choosing DEWETRON means choosing a partner that accompanies you along the entire way. With the purchase of your DEWETRON system, you benefit immediately from the instant access to our global network of professional support, service and various training offers.

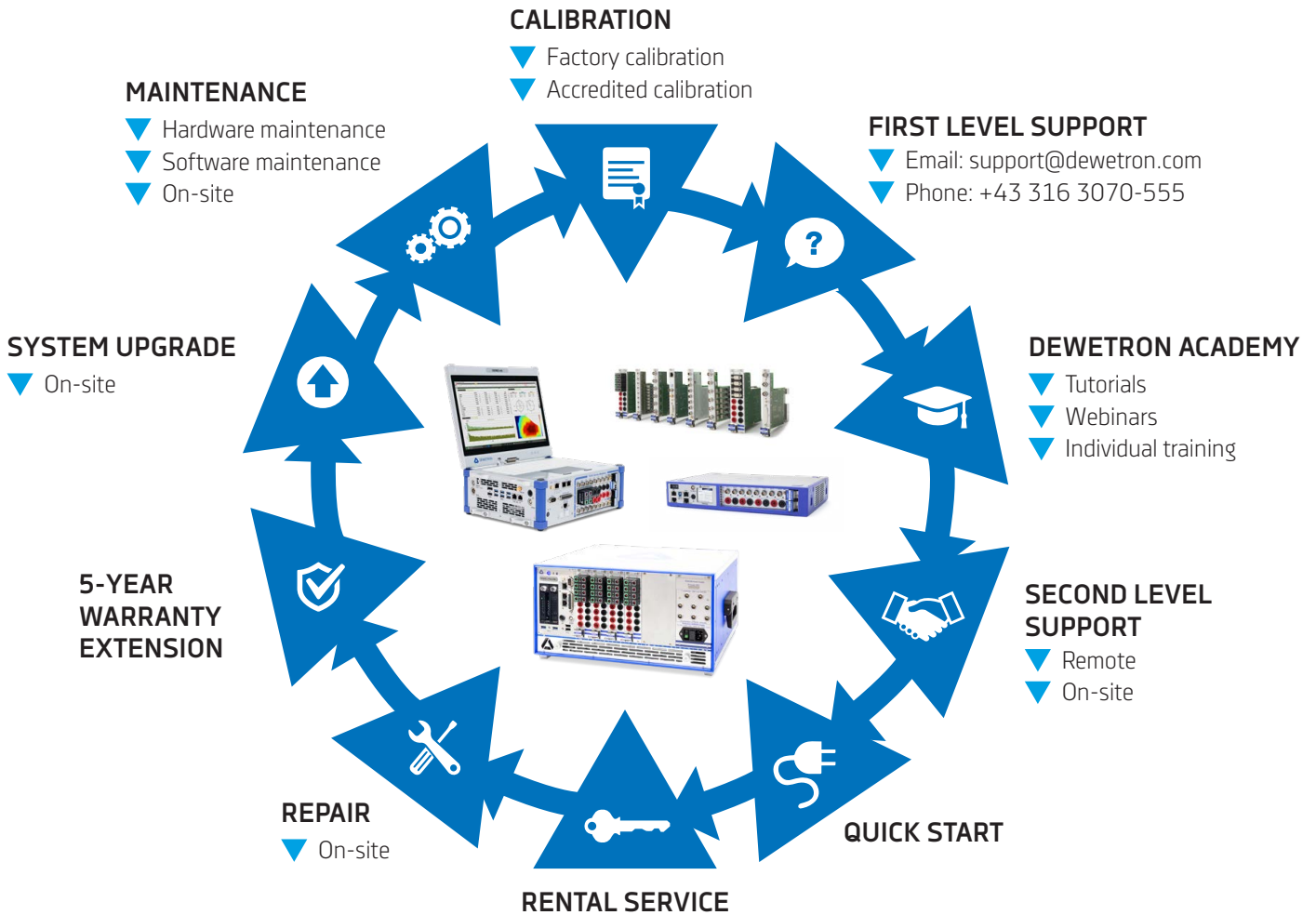

## CONTACT OUR SUPPORT TEAM



[support@dewetron.com](mailto:support@dewetron.com)

+43 316 3070-555

## SEND IN YOUR SYSTEM



For calibration, maintenance and repair issues fill out this form [ccc.dewetron.com/rma](http://ccc.dewetron.com/rma)

## FOLLOW US ON LinkedIn



Follow us on [LinkedIn](#) and you will never miss any DEWETRON update.



# CALIBRATION SERVICES

The accuracy of your DEWETRON data acquisition system is paramount. Thus, all DEWETRON systems are of course calibrated before delivery. By calibrating your DAQ system annually, you can ensure the continued integrity of your measurement data.

- DEWETRON offers two types of calibration:
- > Standard factory calibration
  - > Accredited calibration according to ISO 17025



## ACCREDITED SCOPE

	DC	<b>VOLTAGE (DC)</b>		AC	<b>VOLTAGE (AC)</b>		<b>TEMPERATURE SIMULATION (DC)</b>
	DC	<b>CURRENT (DC)</b>		AC	<b>CURRENT (AC)</b>		<b>TEMPERATURE SIMULATION (RTD)</b>
	DC	<b>POWER (DC)</b>		AC	<b>ACTIVE POWER (AC)</b> up to 850 Hz fundamental frequency		<b>RESISTANCE (DC)</b>

### POWER CALIBRATION

- Especially for your power (analyzer) measurement we offer:
- > Calibration of power values (voltage and current applied simultaneously)
  - > From power-factor 1 down to 0.1
  - > Up to 850 Hz fundamental frequency

Download our  
[detailed CMCs](#)



[ccc.dewetron.com/dl/Scope\\_of\\_Accreditation](http://ccc.dewetron.com/dl/Scope_of_Accreditation)

## WARRANTY EXTENSION UP TO 5 YEARS

Generally, all DEWETRON hardware components are covered by a limited one-year warranty covering parts and labor on a depot basis. This standard warranty may be extended to include up to four additional years of assurance.

The premise for the **warranty extension up to 5 years<sup>1)</sup>** is the annual calibration and maintenance of your DAQ system by the professionals at the DEWETRON factory.

<sup>1)</sup> Please check out our terms and conditions for further details.

### OUR WARRANTY EXTENSION COVERS FOLLOWING PARTS

Category	Part	Covered
CHASSIS	PC hardware (SSD, mainboard)	✓
	Power supply	✓
	DAQ components	✓
MODULES	TRION modules	✓
	Sub-modules	✓
	XR modules	✓

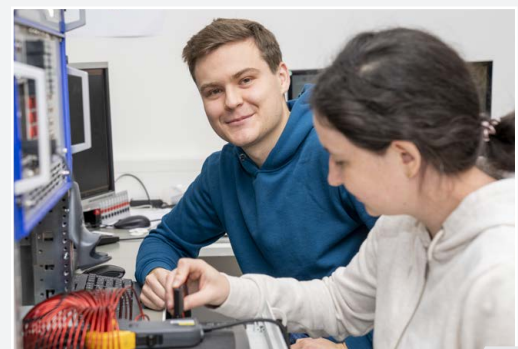

# ELECTRICAL POWER & NVH

IN COOPERATION WITH MÜLLER-BBM VibroAkustik Systeme

- > Optimization of NVH (Noise, Vibration and Harshness) & e-power performance through motor control during testing
- > Target-based development of active components on the test bench
- > Correlation analysis between NVH & e-power data for an all-encompassing engineering approach
- > Combination of NVH & e-power data from several sources in only one view
- > Overall e-NVH system analysis with PTP synchronized measurement data

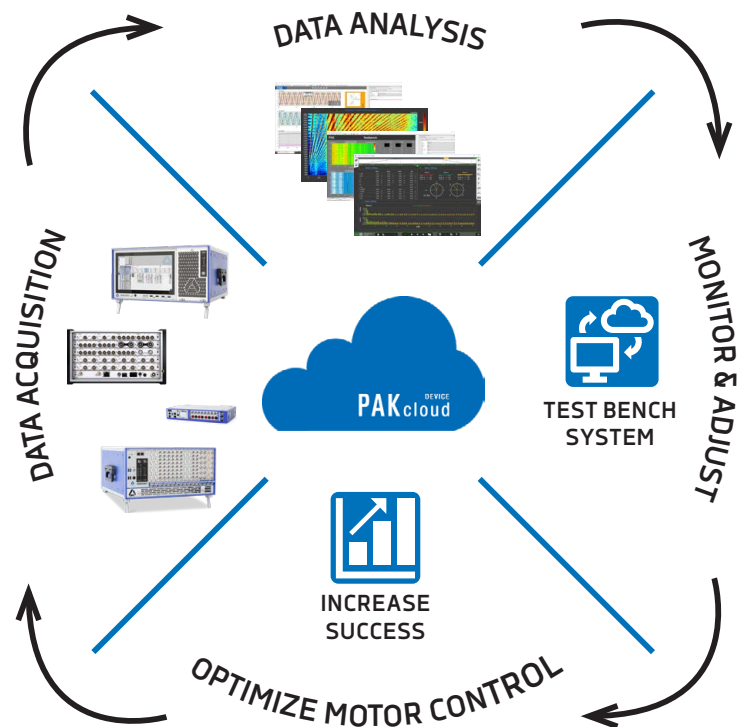

## YOUR ADVANTAGES

- > Online data analysis with the processing of NVH & e-power signals in PAK
- > Seamless integration of DEWETRON's power analyzer into the PAK family
- > Optimization of NVH & e-power performance through motor control on test benches
- > Usage of the proven MBBM-VAS rotating machinery software packages
- > Online simulation of vehicle response on test benches using blocked force methodology
- > PTP synchronized data acquisition
- > 10 MS/s & continuous raw data storage for PWM signals with DEWETRON's OXYGEN

### DEWETRON + OXYGEN

- > Dedicated power analysis of systems with up to 9 phases with various power parameters
- > Highest flexibility due to a modular design & DEWETRON's mixed signal inputs approach
- > Perfect signal synchronization to guarantee the most reliable measurement data integrity
- > Highly dynamic range with tremendous accuracy as a key requirement for test bench applications
- > Continuous & gapless storage of raw data
- > Integrated (redundant) sensor supply for a direct connection to the power analyzer

### MBBM-VAS + PAK

- > Open architecture combining data streams from different sources by a live IO hub
- > NVH software suite with dedicated e-NVH analyses, including Clarke/Park transformation, PWM orders & sound design
- > Direct visualization of acquired quantities & spectral evaluations in the powerful reporting tool (highly interactive graphic functionalities)
- > The perfect solution for troubleshooting, highly standardized tasks, quality assurance, mobile measurements & test bench operation

# ACCESSORIES



## CURRENT TRANSDUCERS

We provide several solutions for current measurement: from simple shunts to current clamps and high-precision zero flux transducers. All transducers can be supplied from the DEWETRON instrument.



## CURRENT TRANSDUCER SUPPLY

We offer a current transducer box to power up to 8 current transducers directly from your DEWETRON DAQ system



## POWER SUPPLY

For mobile applications we provide a battery charger and system power supply with 3 hot-swappable batteries.



## TRANSPORTATION

We offer special sturdy carrying cases for the safe transport of all our measurement systems.

# VIDEO CAMERAS



## HIGH SPEED CAMERAS UP TO 100,000 FPS

- > Independent from HS camera system
- > Can be added to every DEWETRON system
- > Measurement screen can be exported as video report
- > Analysis can be done on every computer

## USB / ETHERNET CAMERAS UP TO 289 FPS

Rugged and lightweight ALVIUM industrial cameras with high image quality with up to 289 fps. Several models with different resolution and USB 3.0 or GigE connection.



## ABOUT DEWETRON

DEWETRON은 정밀 테스트 및 계측 시스템 제조업체이며, 글로벌 기업인 Anritsu Group의 일원입니다. 당사의 신뢰성 높은 계측 데이터는 전 세계 고객들이 프로세스를 더욱 예측 가능하고, 효율적이며, 안전하게 운영할 수 있도록 지원합니다. 당사의 강점은 고객 맞춤형 계측 솔루션에 있습니다. 즉시 사용할 수 있도록 준비되어 있으면서도, 에너지·자동차·운송·항공우주 산업의 변화하는 테스트 요구사항에 유연하게 대응할 수 있습니다. 37년 이상의 경험과 혁신을 바탕으로, DEWETRON은 글로벌 테스트 및 계측 시장에서 신뢰받는 파트너로 자리매김해 왔습니다.

전 세계 주요 기업들은 현재 25,000대 이상의 DEWETRON 계측 시스템과 400,000개 이상의 측정 채널을 지속적으로 사용하고 있습니다. DEWETRON의 품질은 ISO 9001 및 ISO 14001 기준에 따라 인증받았습니다. 또한 계측 데이터의 높은 무결성은 ISO 17025 인증을 받은 자체 교정 연구소를 통해 보장됩니다.

THE MEASURABLE DIFFERENCE.

Get to know our  
GLOBAL OFFICES



DEWETRON

데베트론테크놀로지코리아

경기도 안양시 동안구  
흥안대로 457-25, 612호  
dewetron@dewetrontech.co.kr  
+82 31 689 4502  
dewetron@dewetrontech.co.kr  
www.dewetrontech.co.kr

